

# MIAMI BEACH STREET DESIGN GUIDELINES

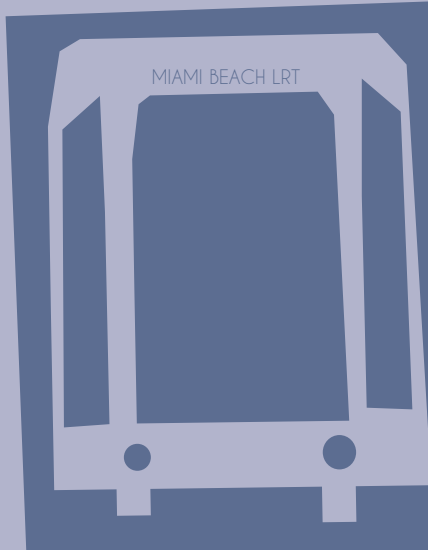
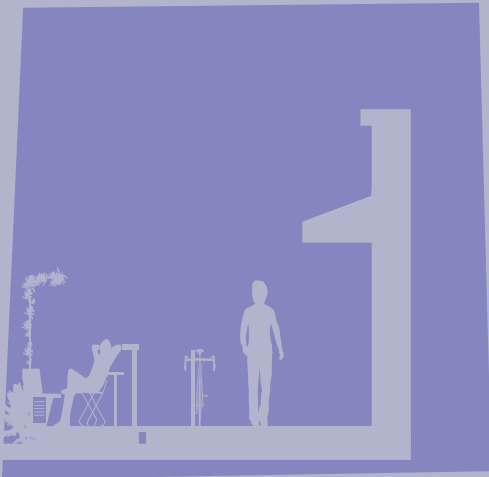

PREPARED BY: THE STREET PLANS COLLABORATIVE

April 2016

Communities around the world are rediscovering the multifaceted value of vibrant streets and robust street networks. Streets are a vital part of urban life, which often comprise a large percentage of the built environment. This guide serves to illustrate the possibilities and outcomes that street design can have towards inclusive, multi-modal transportation for the City of Miami Beach.

## **ACKNOWLEDGMENTS**

### **MAYOR PHILIP LEVINE**

### **CITY OF MIAMI BEACH CITY COMMISSION**

MAYOR PHILIP LEVINE

COMMISSIONER MICKY STEINBERG  
COMMISSIONER MICHAEL GRIECO  
COMMISSIONER JOY MALAKOFF  
COMMISSIONER KRISTEN ROSEN GONZALEZ  
COMMISSIONER RICKY ARRIOLA  
COMMISSIONER JOHN ELIZABETH ALEMAN

### **CITY OF MIAMI BEACH STAFF**

JIMMY MORALES, CITY MANAGER  
KATHIE BROOKS, ASSISTANT CITY MANAGER  
JOSE GONZALEZ, PE – TRANSPORTATION DIRECTOR  
ERIC T. CARPENTER, P.E. – ASSISTANT CITY MANAGER / DIRECTOR OF PUBLIC WORKS  
JOSIEL FERRER, E.I – TRANSPORTATION COORDINATOR  
XAVIER FALCONI, PE – TRANSPORTATION PLANNER

### **THE STREET PLANS COLLABORATIVE**

ANTHONY GARCIA  
MIKE LYDON  
SUOM FRANCIS



# TABLE OF CONTENTS

|  |     |
|--|-----|
| EXECUTIVE SUMMARY                                | 07  |
| 1. INTRODUCTION                                  | 08  |
| THE PURPOSE OF THIS GUIDE                        | 06  |
| COMPLETE STREETS                                 | 07  |
| DESIGN PRIORITIES + PRINCIPLES                   | 08  |
| NEIGHBORHOOD GREENWAY/ BICYCLE PRIORITY CORRIDOR | 12  |
| PEDESTRIAN PRIORITY ZONE                         | 13  |
| 2. STREET TYPES + COUNTERMEASURES                | 17  |
| INTRODUCTION : STREET TYPES                      | 16  |
| PEDESTRIAN SAFETY                                | 31  |
| BICYCLIST SAFETY                                 | 37  |
| Neighborhood Greenways                           | 41  |
| Unprotected Facilities                           | 49  |
| Protected & Segregated Bike Facilities           | 57  |
| Intersections / Junctions                        | 67  |
| COUNTERMEASURE MATRIX                            | 84  |
| SPECIAL CONDITIONS                               | 85  |
| 3. STREETScape                                   | 95  |
| MATERIALS  | 96  |
| STREET FURNISHINGS                               | 98  |
| LANDSCAPE ELEMENTS                               | 99  |
| LIGHTING   | 100 |
| FRONTAGE   | 103 |
| PARKLETS   | 105 |
| BICYCLE PARKING                                  | 113 |
| SIGNALS & SIGNS                                  | 127 |
| WAYFINDING                                       | 136 |
| 4. TEST BEFORE YOU INVEST                        | 139 |
| COMMUNITY ENGAGEMENT                             | 140 |
| TACTICAL URBANISM                                | 141 |

## THE PURPOSE OF THIS GUIDE

The Miami Beach Street Design Guide is meant to be a starting point for engineers, city staff, and citizens in their ongoing work to provide safer streets for Miami Beach residents and visitors, and in the implementation of the 2016 Transportation Master Plan and Bicycle Pedestrian Plans.

Unlike previous street design standards, and previous guidelines, this Street Design Guide offers city staff and residents with design concepts and details that refocus attention on walking, biking, transit use, and away from car use. This guide has been developed to address the following needs:

- To design streets that create a safe environment for all users, recognizing differences among modes.
- To act as a tool for the transition of Miami Beach from a vehicle trip-based system to a multi-modal one and support the long term vision of the Miami Beach Transportation plan.
- To revitalize street networks in order to allow greater route choice for pedestrians and bicyclists thus relieving traffic congestion and promoting physical activity.
- To promote the creation of third-places where social interactions can take place by redesigning existing streetscapes.
- To provide standards for the implementation of projects found in the Transportation Master Plan and the Bicycle Pedestrian Master Plan.
- To test designs and collect data related to how streets are actually used by people living in the city.

This document moves away from auto-centric nomenclature like arterial, collector, and local, with their focus on moving cars, and returns to a people-oriented nomenclature like boulevard, main street and shared space that is about how people move around. More than anything this shifts design expectations and the way people interact with the city.

The following pages detail the possible configurations found in the various types of streets proposed. In no way is this a comprehensive listing of techniques or designs, but rather this is a starting point for engineers, designers and citizens as they formulate projects moving forward.

It is important to note that not all of the designs included herein have been adopted by the Florida Department of Transportation. **BY ADOPTING THESE DESIGNS THE CITY ASSUMES ITS ROLE AS A LEADER IN THE REGION IN REFORMING REGIONAL STREET DESIGN STANDARDS IN FAVOR OF BICYCLISTS AND PEDESTRIANS.**

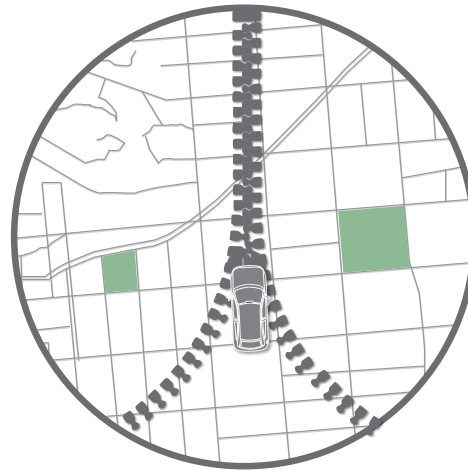
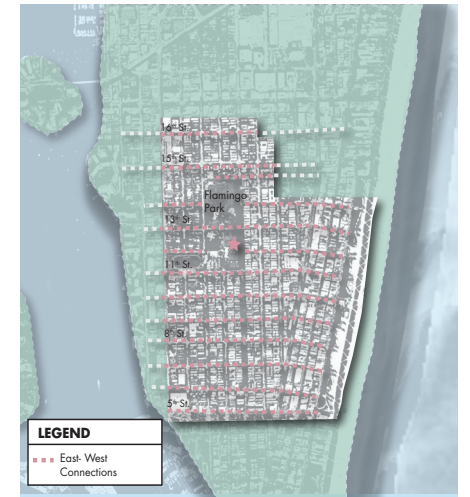

Fig. 1.1 Vehicle-oriented street design segregates uses in communities.



Fig. 1.2 Multi-modal streetscape design allows for inclusion, efficiency and rich social interaction.



The Street Design Guide was crafted as a part of a three year planning effort that included community meetings, a field survey of existing conditions, and a detailed analysis of all neighborhoods within Miami Beach. What this process found was that Streets in Miami Beach are well traveled by bicyclists and pedestrians alike, but challenges abound, from missing street trees on many streets, to the lack of protected bicycle facilities.



**“A BUSY STREET IS A SAFE STREET”**

The overarching idea that city leaders and designers should remember when using this document is that designing truly great streets means accommodating various methods of transportation and users, and scaling everything for the pedestrian. Our goal should always be to create vibrant places for people to inhabit and that generate activity that will attract other people. Our streets are more than just conduits for cars, and should serve to move people more than cars.

There are many ways to describe this approach, among them is the term **Complete Streets**. Although there is no specific formula for Complete Streets design, it is an approach that places pedestrians and bicyclists at the top of the planning hierarchy and seeks to put public life back into the public realm. Basic elements of complete streets include:

- Providing pedestrians with a contiguous network of wide, shaded sidewalks with safe and frequent crosswalks.
- Having consistent active frontage, with windows facing the street, buildings that line the sidewalk, and land uses that support walking and transit use.
- Having a protected, low stress bicycle network that allows people to commute and/ or exercise by bike.
- Provide spaces where neighbors can gather and enjoy.
- Characterized by reduced auto speeds

With the advent of self driving cars the nature of street design and the standards that accompany them will change dramatically.



credit: www.usa.streetsblog.org



credit: www.inhabitat.com



credit: www.behbg.com



credit: www.momentummag.com



credit: www.citylab.com



credit: wny.org

**DO THIS!**



**DON'T DO THIS!**

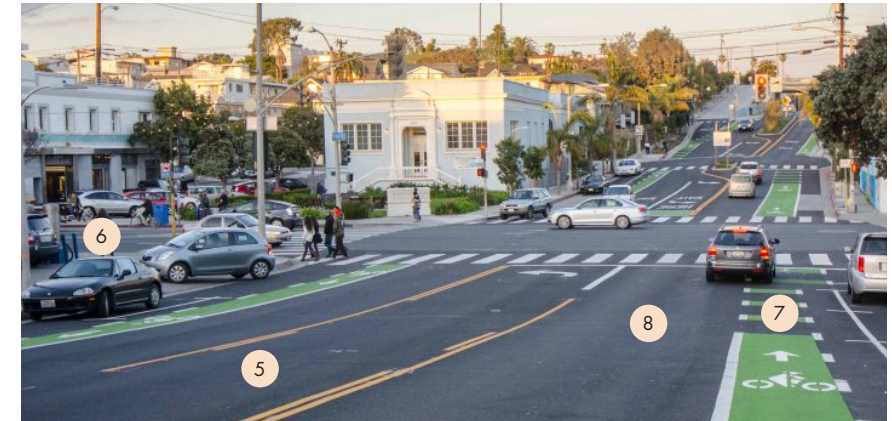

1. Provide wide sidewalks - with lots of trees!
2. Dedicated bicycle facility (protected recommended).
3. Median refuge island, pedestrian protection & traffic calming.
4. Narrow travel lane
5. Double turn lane = wasted space - give this back to the pedestrian!
6. Poor building frontage
7. Unprotected bike lanes on a high speed road -
8. Wide travel lanes - encourage speeding.

Fig. 1.3 Examples of “complete streets” elements.

**STREETS FOR ALL**

How we design our streets has a huge impact on our behavior. Designing for automobiles has been the highest priority in roadway design for over 75 years. The effects of this planning paradigm have been disastrous in their effect on our cities, our health and our environment.

This last point is most relevant to Miami Beach. As one of the places most at risk in the United States of sea level rise, reprioritizing non-fossil fuel based modes is a matter of basic survival.

A basic observation has held true during this time: the more you plan and build for cars, the worse traffic and congestions become. It is a negative feedback loop where car use begets more car use, at the expense of any other option. There is no amount of planning or engineering that will reduce or eliminate traffic congestions. It is a basic part of living in a city. The best thing that city leaders and planners can do is provide safe and abundant options for folks to get around.

This guide seeks to respond to a local and national paraigm shift that acknowledges that people will still drive, but that they need greater transportation choices. Street design should reflect both the current way folks move around the city, and the long term modal priorities established by the city commission.

Street design must prioritize comfortable and safe multi-modal transportation for all users including elderly, children and mobility impaired users.

The design standards included in this document are intended to makes streets safer, easier and more convenient for everyone by designing spaces so that they

can be used by the widest range of people possible.

The standards included herein recognize that there is a wide spectrum of human abilities. Everyone, even the most able-bodied person, passes through childhood, periods of temporary illness, injury and old age.

The overall priorities of this document include:

- Slower car speeds. There should be no street in Miami Beach that has speeds over 30 mph.
- Bicycle facilities that are continuous, protected and visually distinct from motor travel lanes and pedestrian areas.
- Sidewalks that are wide, shaded and well maintained.
- Abundant and closely spaced crosswalks.
- signal timing that favors bicycle and pedestrian use over traffic flow.
- Signage and Wayfinding that is easy to interpret by international populations (symbols rather than words).
- Braille for signage and tactile surfaces like warning strips.
- Spoken warnings for street crossings and general navigation of space.

In the following section, we outline specific priorities by mode, along with relevant data for each.

***“There is no amount of planning or engineering that will reduce or eliminate traffic congestion. The best thing that city leaders can do to address traffic is provide safe and abundant options for folks to get around.”***



**PEDESTRIANS**

Pedestrians are the fundamental users of our city streets. As of 2016, about 15% of all trips are taken by foot for a significant portion of their trip. Design parameters for pedestrians include:

- Consistent shade (sun intensity)
- Continuous, even sidewalks
- Smooth, slip resistant surfaces and unobstructed walkways.
- A maximum pedestrian crossing distance of 50 feet with appropriate treatments. (see countermeasures).
- A maximum distance between marked crossings of 250'
- Consistent shelter (rainy season)
- Multi-sensory warnings such as audible warnings, and message systems, tactile warnings, and raised and Braille for communication.

**FREQUENT SOURCES OF INJURY % (2012)**

|  |    |
|--|----|
| Tripped on uneven surface/cracked sidewalk | 24 |
| Tripped/Fell                               | 17 |
| Hit by a car                               | 12 |
| Wildlife/pets involved                     | 6  |
| Stepped in a hole/stone                    | 5  |

[www.nrd.nhtsa.dot.gov/Pubs/812124.pdf](http://www.nrd.nhtsa.dot.gov/Pubs/812124.pdf)

**PEDESTRIAN FACTS (2013)**

|   |
|---|
| 4,735 killed (12 people x day all year)       |
| 66,000 PED injuries reported                  |
| 5.2 B/year [cost of ped injuries of children] |

[www.nhtsa.gov/nti/811841](http://www.nhtsa.gov/nti/811841)





**BICYCLISTS**

Bicycling currently accounts for 5% of trips in Miami Beach. Moving forward all streets in Miami Beach should be safe for bicyclists, whether they have dedicated lane or not. Typical cycling speed is 10-18 mph. However, bicyclists can travel as slow as 5 mph up to 30 mph. Design parameters for bicyclists include:

- Continuous, connected bikeways
- Protected, clearly marked intersections
- Consistent shade
- Abundant, and easily accessible bicycle parking
- low stress bikeways that are either:
  - greenways on streets with volumes less than 1,000 vpd
  - protected bike lanes (protected by parking, bollards, planters, etc)
  - off-road paths
  - sidewalk level cycle tracks

**FREQUENT SOURCES OF INJURY % (2012)**

|                         |    |
|-------------------------|----|
| Hit by a car            | 29 |
| Fell                    | 17 |
| Poor road condition     | 13 |
| Rider error             | 13 |
| Crashed/ Collision      | 7  |
| Wildlife / Pet involved | 4  |

[www.nhtsa.gov/nti/811841](http://www.nhtsa.gov/nti/811841)

**BICYCLIST FACTS (2013)**

|   |
|---|
| 743 bicyclist reported killed                   |
| 48,000 bicyclist injuries reported              |
| Over 4B /year [cost of biking injuries & deaths |

[www.nrd.nhtsa.dot.gov/Pubs/812151.pdf](http://www.nrd.nhtsa.dot.gov/Pubs/812151.pdf)



**TRANSIT RIDERS**

Transit users currently account for 10% of the trips in Miami Beach. Because most transit users arrive to transit via walking or biking, their needs are fundamentally similar. Their need to wait for transit adds the dimension of seating, shade, shelter, and the need to be able to cross streets efficiently and conveniently to access transit stops.



**MOTORISTS: DESIGN SPEED**

As mentioned, street design plays a crucial role in user behavior. Nowhere is this more evident than in the principle of design speed. When it comes to vehicular traffic, car based traffic engineering specifies a design speed of the road, which is often well above the posted speed. This speed is tied to physical parameters such as lane width, signal timing and curb radii.

This guide turns away from this methodology by requiring that vehicular design speed be directly correlated with the desired travel speed of the motor vehicles, or "target" speed. Target speeds should range from 18-30 mph for the street types described in this guide. The lower end of this speed range is a crucial characteristic of a safe and walkable city. The following design factors contribute to speed management and should be incorporated into the street designs moving forward:

- Lanes of appropriate width without surplus (10' or less for regular travel lanes).
- No "shy" areas or shoulders between travel lanes and curbs.
- On-street parking.

- Curb return radii at intersections of less than 20' and elimination or reconfiguration of high-speed channelized right turns.
- Spacing of signalized intersections and synchronization of signals to the desired speed, and coordinated with desired pedestrian crossing times.
- Paving materials with texture (crosswalks, intersections) detectable by drivers as a notification of the possible presence of pedestrians.
- Vertical shifts, such as raised pedestrian crossings and intersections
- Street trees
- Curb extensions.
- Bicycle infrastructure and amenities.

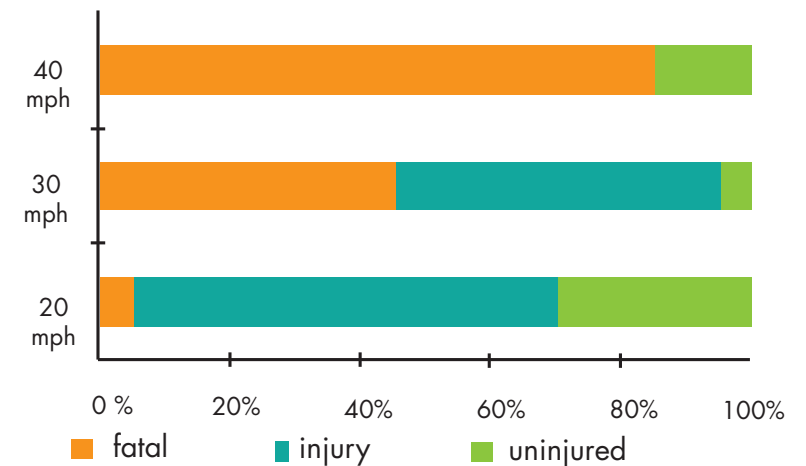

Fig. 1.4 There is a direct correlation between injury/fatality rates and car speed. To ensure limited fatalities and injuries most streets should have posted limits under 20mph, with major streets at a maximum of 30 mph.

# WHY MULTIMODAL STREET DESIGN IS IMPORTANT



## **COST- EFFECTIVENESS**

Long range planning and a defined set of design standards that shift the focus from exclusively auto-centric to multimodal design considers the full life-cycle costs and benefits when developing street designs. Besides their initial capital outlays, the measurable long-term economic, environmental, safety, health, and other benefits of well-designed, well-managed streets should be taken into consideration.



## **ACTIVE LIVING**

Miami Beach's weather and beautiful beaches promote active lifestyles. For this reason alone, Miami Beach should be among the most bicycle and pedestrian friendly places in the nation. Re-designing streets should always encourage safe and healthy living considering that outdoor recreation is already popular on the beach. This guide seeks to expand on existing trends emphasizing safety.



## **ARTS/ CULTURE**

Miami Beach is an art/music destination hosting multiple music festivals and events through out the year.

Providing robust multi-modal infrastructure has the potential to impact citizen engagement and continue to attract cosmopolitan urban dwellers who are accustomed to better transportation infrastructure around the world. .



## **HOSPITALITY, NIGHT LIFE**

Miami Beach is one of the most famous tourist destinations in the world. Developing reliable multi-modal transportation and enhancing transit options would and better serve a tourist population that by and large does not drive. For example, bicycle maps produced by the city should be shared with concierge groups in order to provide information to tourists about how to get around.



## **MULTICULTURAL POPULATIONS**

Miami Beach is known as a major destination for Florida locals and international visitors of all ages and backgrounds. Making streets more desirable places to be, enhances the inter-cultural networks of its residents and visitors alike. Miami Beach is a place where everyone can feel like they belong. Diversity is an important asset that can be strengthened through design.

## WHY MULTIMODAL STREET DESIGN IS IMPORTANT



### **SAFETY**

Perception of safety is directly related to the level of street activity across all modes of transportation. Safe streets enhance civic interactions for people of all ages and cultures. The City shall prioritize safety for all street users, particularly more vulnerable groups (children, elderly, the mobility impaired, and more vulnerable modes such as walking and bicycling).



### **ACCESS & MOBILITY**

A growing population, a large tourism influx, the need to design for people aging in place and limited right-of-way, require street designs to be innovative and adaptable. Designs should provide efficient ways to move people and goods across all modes of transportation, and be designed to promote physical activity for all ages and populations by making walking, bicycling, and transit safe, attractive and convenient.



### **CHARACTER**

Streets play a significant role in defining the character of neighborhoods. Their design should refer to the surrounding context, and promote the neighborhood's historical value. Many of the best streets in South Florida are in Miami Beach.



### **LIVABILITY**

Streets comprise an extensive network of public open spaces that can facilitate vibrant social, civic, and economic interactions. Expand usable public open space by reallocating underutilized roadway space to create pedestrian plazas, expanded sidewalks, corner and mid-block curb extensions, and opportunities for landscaping and storm water management. Include public seating when there is an appropriate maintenance partner.



### **RESILIENCY**

Street design has the capability to improve the environmental health of the city. Considering the long term impacts of sea level rises, Miami Beach has an obligation to begin to address these challenges. All new street reconstructions should include significant raising of the street to prepare for sea level rise.







## STREET TYPES + COUNTERMEASURES

Street design has a direct impact on how the public realm is used, the safety of its users and therefore the vibrancy of the City. This section introduces the basic concepts of street design, and typical street configurations for people who walk, bike and use public transit. These types are coordinated with the recommendations set forth the Bicycle Pedestrian Master Plan.

This guide moves away from auto-centric nomenclature like arterial, collector, etc, and returns to people-oriented nomenclature like boulevard, main street and shared space, effectively shifting design expectations and the way people interact with the built environment.

The following pages detail the potential configurations of typical streets. The designs proposed here aim to:

- Be inclusive of all users of the public realm.
- Help make the City more resilient to climate change by showing how streets can be raised over time.
- Make all users safe regardless of their choice of transportation method

## ANATOMY OF A STREET SECTION

Streets are complex public spaces that support a wide range of people trying to move around. By placing “people” at the center of street design, we remember that the role streets play as part of the public realm, not simply as conduits for car movement.

This section defines the composition of the street in relation to people and the elements they need in order to have a safe and enjoyable experience.

1. The Building **FRONTAGE** is the front facade of the building. It may be either part of the public Right of Way or part of the setback. Building frontage can either be public or private, and varies depending on whether the building is residential or commercial.

The setback area may be an extension of the sidewalk, or an additional landscape strip. In more urban conditions there is no setback.

Buildings contain appurtenances that compose public frontage. These can be storefronts with awnings, or arcades that cover the sidewalk, or stoops. These are detailed in section X.

2. The **PEDESTRIAN REALM** is made up various elements including:

- Sidewalk
- Furnishing Zone, with lights, benches, trash cans, bike parking, and other amenities.
- **Landscaping** (either a tree well or landscape strip depending on the context)
- **Curb Type** (no curb, swale, curb & gutter)

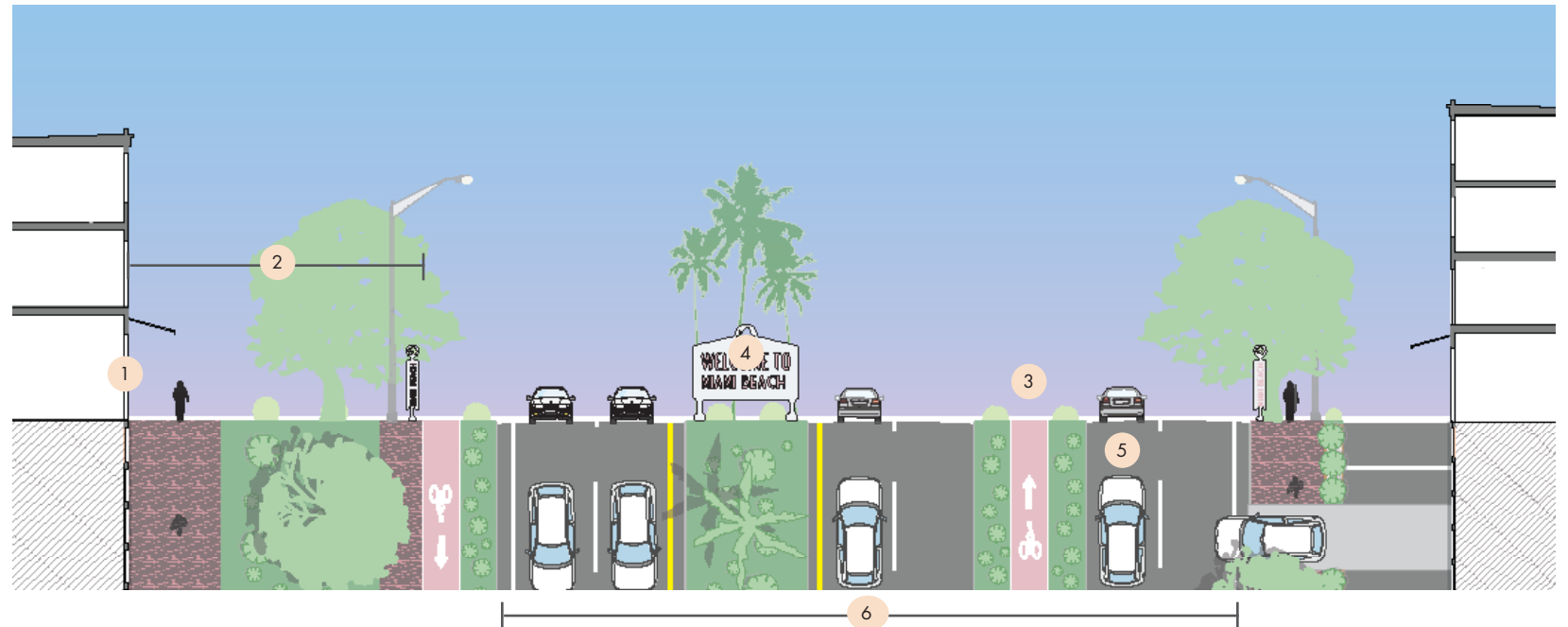

Fig 2.1 General multi-modal streetscape components.

3. **BIKEWAYS** can be implemented in a variety of ways depending on context and desired low-stress condition. This section shows a protected, sidewalk-level protected bike lane.

Bicycle facilities may be provided in the form of on-street bike lanes, sidewalk-level bike lanes and off-road paths, which have a defined space for bicyclists, or as on-street greenways, which are not physically separate from drivers, though they may be marked with sharrows, and have other elements that slow traffic to indicate bicyclist priority.

4. **On-Street Parking** is an essential element to most streets.

4. A **MEDIAN** is a space in the center of the road that may contain a TURN LANE, a PEDESTRIAN REFUGE, or a LANDSCAPE STRIP. Depending on which is used these elements can help streets be safer to cross for pedestrians, or have more shade, thus reducing the urban heat island effect depending on configuration.

5. **TRAVEL LANES** should be a standard maximum of 10 feet for standard traffic (non transit or freight). This width provides comfortable travel, slows traffic, and allows for R.O.W reconfiguration. Some travel lanes should be DEDICATED TRANSIT LANES which only accommodate buses and trains. These may be a maximum of 11’.

6. The **TRAVEL WAY** is the curb to curb dimension of the street. It may accommodate landscaping, medians, transit facilities, bicycle facilities as well as vehicular travel.

On this page and the pages that follow, users of the guide will find typical sections for streets that may be found throughout Miami Beach. They are described by their overall width, adjacent land use and urban form.

In each drawing you will find the appropriate bikeways to be used in each street type, as well as landscaping and curb types.

At the bottom of the page is a translation from the functional classification nomenclature to the types included in this guide for the benefit of coordination with state and federal standards which still use this antiquated convention.

Fig 2.2 Street Type matrix.

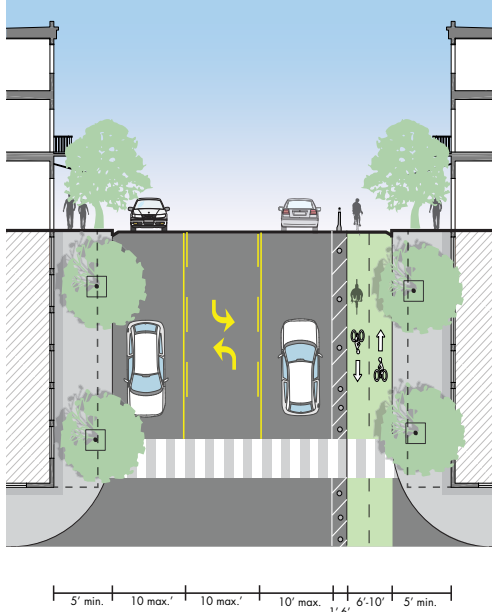
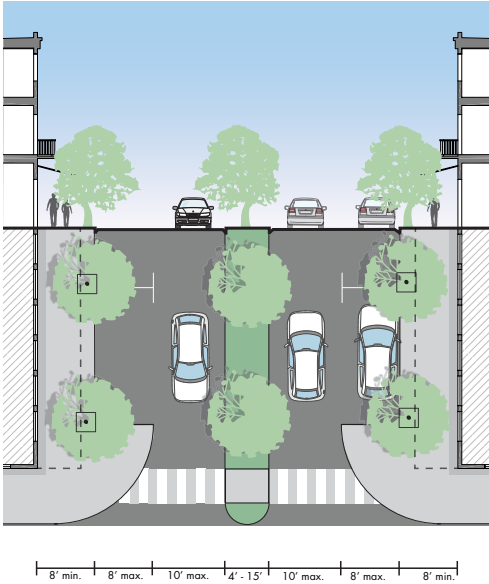
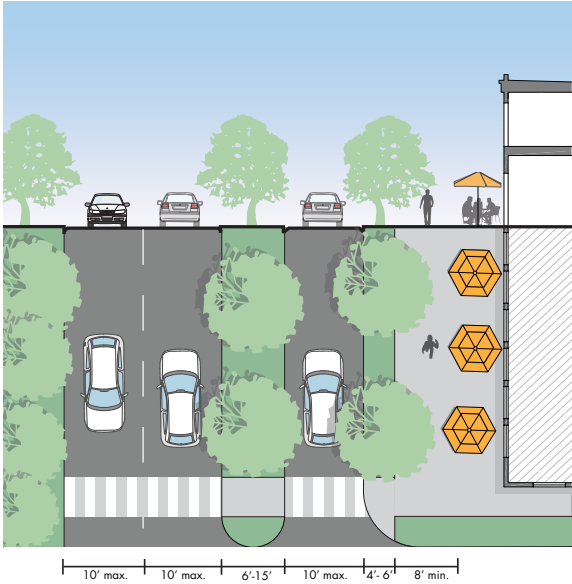

|              | <b>BOULEVARD</b>   |
|--------------|--|
|              | 115' -1 50' wide   |
| Travel Lanes | 1 - 2 slip/frontage road(s)<br>2 - 4 Inner lanes, median               |
| Bikeways     | Shared Path<br>Off Street Bike Lanes<br>On Street Protected Bike Lanes |
| Parking      | On street Parallel Parking   |
| Landscaping  | Tree Well<br>Swale   |
| Curb type    | Curb & Gutter  |

Example: Collins Avenue between 41 Street and 71 Street.

|              | <b>AVENUE (Urban)</b>  |
|--------------|--|
|              | 75' - 90 wide'   |
| Travel Lanes | 2 - 4 lanes<br>median  |
| Bikeways     | Shared Path<br>Off-Street Protected Bike Lanes<br>On-Street Protected Bike Lanes |
| Parking      | On street Parallel Parking   |
| Landscaping  | Tree Well  |
| Curb type    | Curb & Gutter  |

Example: Alton Road between 5 Street and 17 Street.

|              | <b>MAIN STREET</b>   |
|--------------|--|
|              | 50' - 70' wide   |
| Travel Lanes | 2 - 4 lanes  |
| Bikeways     | Shared Path<br>On-Street Bike Lanes<br>Off-Street Bike Lanes |
| Parking      | On street Parallel Parking                                   |
| Landscaping  | Tree Well  |
| Curb type    | Curb & Gutter  |

Example: 71 Street



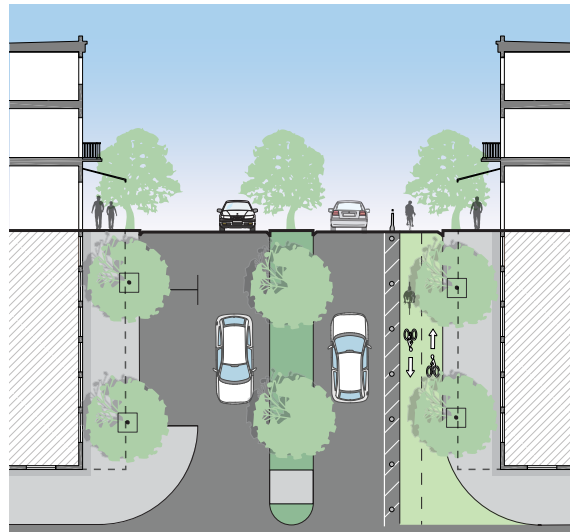

8' min, 8' max, 10' max, 4'-10', 10' max, 1'-4', 8'-12', 8' min

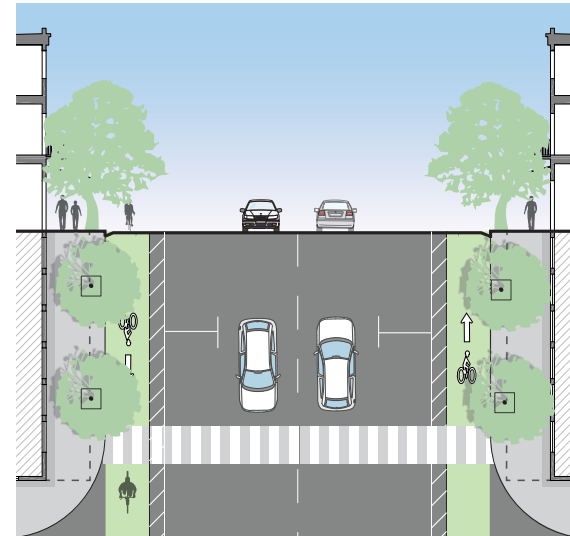

8' min, 5' min, 3' min, 8' max, 10' max, 10' max, 8' max, 3' min, 5' min, 8' min

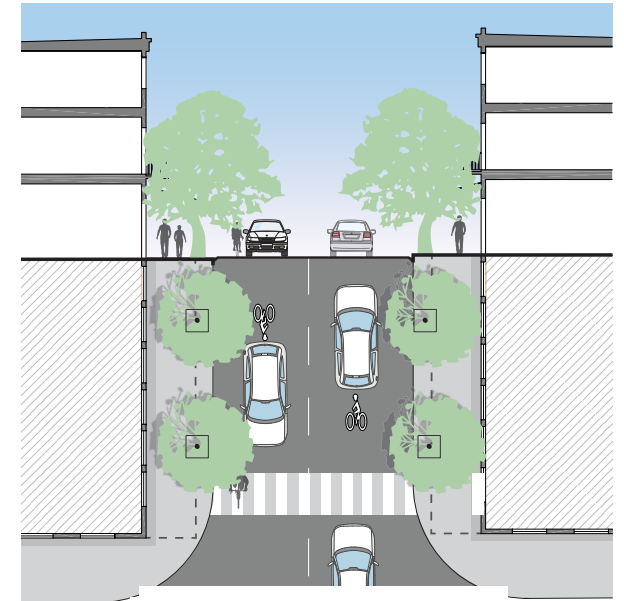

5' min, 10' max, 10' max, 5' min

**AVENUE (SUBURBAN)**

|                                  |
|----------------------------------|
| 75' 90' wide                     |
| 2-4 lanes                        |
| Shared Path                      |
| Protected Bike Lanes             |
| Light/Heavy Greenway             |
| Parking Protected Bike Lanes     |
| On Street Angled Back-in Parking |
| On street Parallel Parking       |
| Tree Well / Planter              |
| Swale                            |
| Curb & Gutter                    |

**NEIGHBORHOOD STREET (URBAN)**

|                                  |
|----------------------------------|
| 75' 90' wide                     |
| 2-4 lanes                        |
| Shared Path                      |
| Protected Bike Lanes             |
| Light/Heavy Greenway             |
| Parking Protected Bike Lanes     |
| On street Parallel Parking       |
| On Street Angled Back-in Parking |
| Tree Pits                        |
| Connected Tree Pits              |
| Curb & Gutter                    |

**NEIGHBORHOOD STREET (SUBURBAN)**

|                                  |
|----------------------------------|
| 75' 90' wide                     |
| 2-4 lanes                        |
| Shared Path                      |
| Protected Bike Lanes             |
| Light/Heavy Greenway             |
| Parking Protected Bike Lanes     |
| On street Parallel Parking       |
| On Street Angled Back-in Parking |
| Tree Pits                        |
| Connected Tree Pits              |
| Swale                            |
| Curb & Gutter                    |

- Travel Lanes
- Bikeways
- Parking
- Landscaping
- Curb type

Functional Classification

**LOCAL**

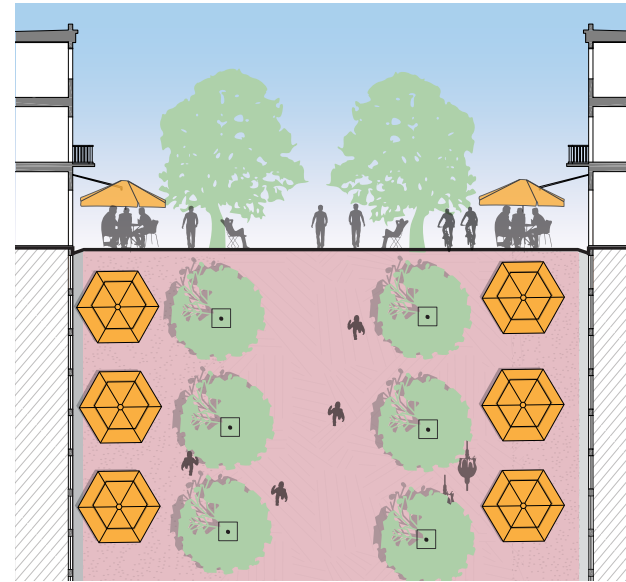

7' min. | 8' min. | 20' max. | 8 min. | 7' min.

**SHARED SPACE**

|                     |
|---------------------|
| 50' -100' wide      |
| 2 lanes unmarked    |
| Shared Lanes        |
| Tree Pits           |
| Connected Tree Pits |
| Curbless            |

**NON-MOTORIZED STREET**

|                     |
|---------------------|
| 50'-75' wide        |
| Shared Path         |
| Tree Pits           |
| Connected Tree Pits |
| Curbless            |

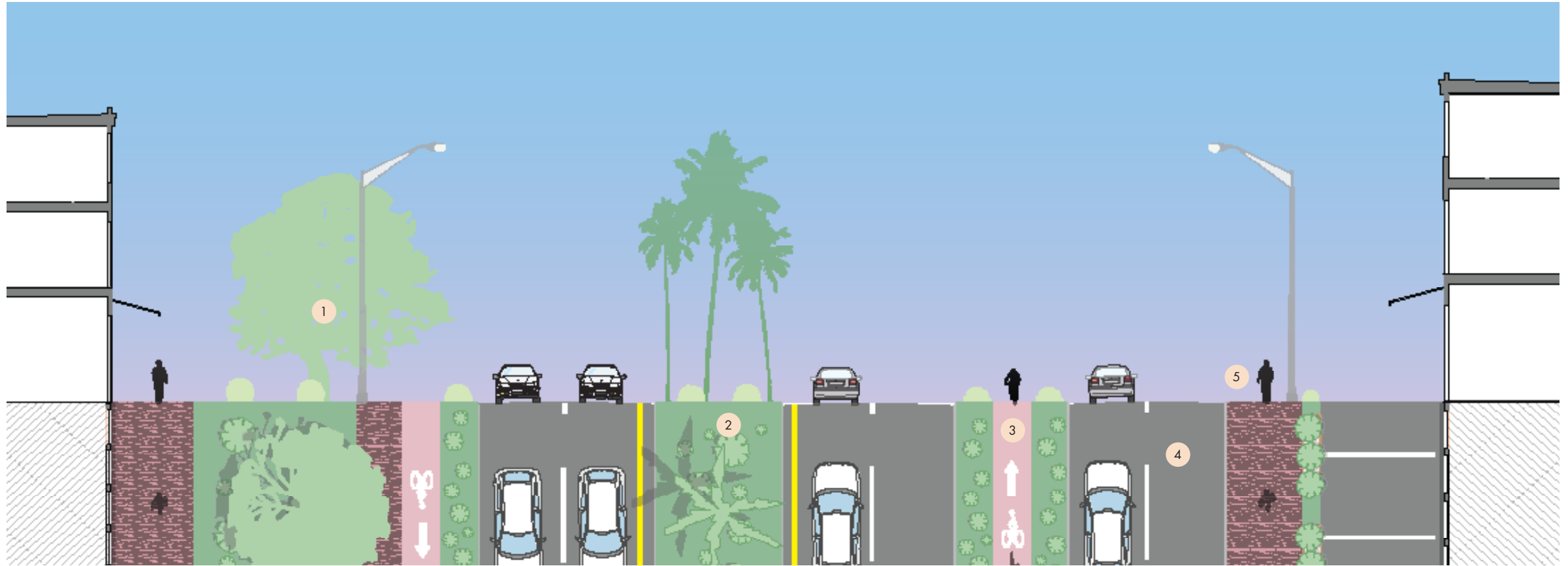

Fig 2.3 Standard multi-modal boulevard streetscape assembly.

The term “boulevard” usually refers to a grand city street with wide sidewalks, and tall buildings. They are the widest corridors and act as grand promenades between important destinations. These corridors typically have two sets of roadways separated by medians, with the inner roadway(s) intended for through traffic and the outer (frontage roads) for local traffic. Boulevards boast an exceptional level of landscaping, public open space, and street enclosure. The medians and frontage lanes sometimes include pedestrian and bicycle paths.

Boulevards can be both commercial and residential, and should not have speeds over 35 mph. In Miami Beach examples of boulevards include Collins Avenue and 5 Street.

**TYPICAL TREATMENTS**

- 1 Trees in Tree well or landscape strip
- 2 Medians with robust landscaping
- 3 Protected and Painted Bicycle facilities
- 4 Frontage road for local traffic
- 5 Wide, shaded sidewalks

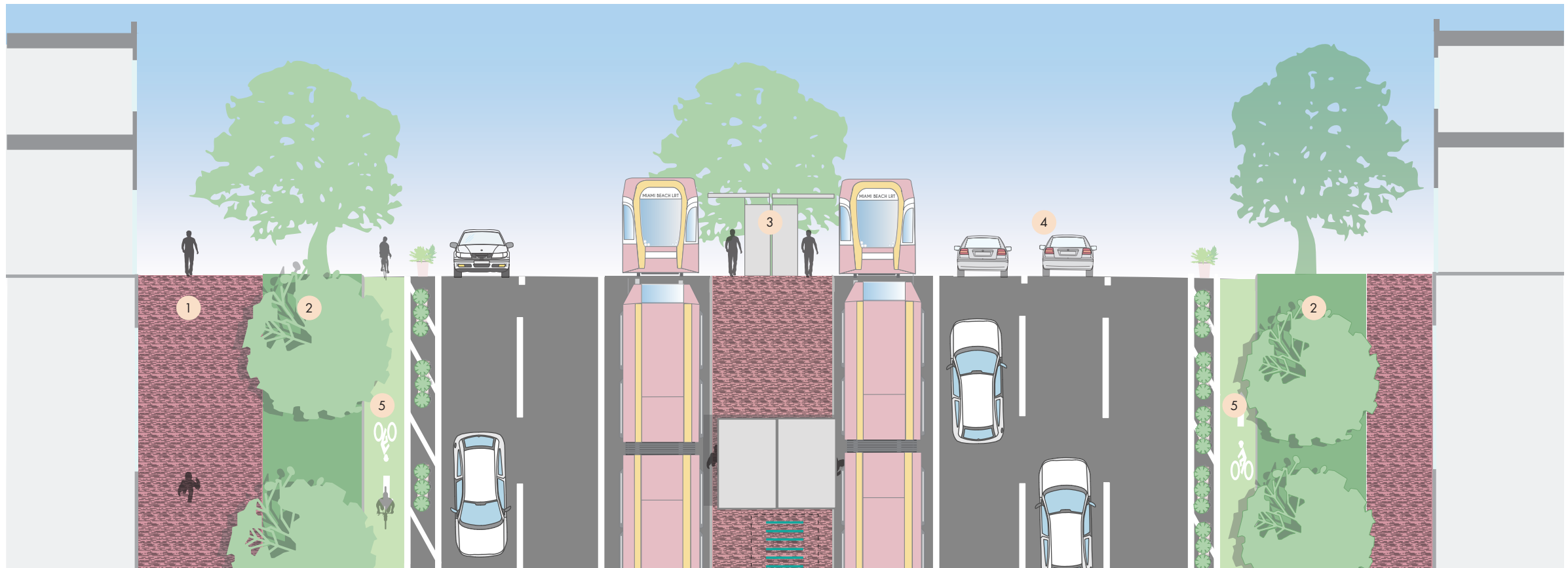

Fig 2.4 Typical multi-modal transit boulevard streetscape assembly at platform section.

The Avenue is another wide street type. It has two variations, one that is urban, and the other suburban. As with the boulevard it may have dedicated transit, as in the example above. The urban avenue will have tree wells, rather than a landscape strip, urban building frontage, and excellent pedestrian access to and along the transit stations. Bicycle access should be supported where possible depending on ROW width, but in most cases transit takes priority on these streets.

Urban avenues emphasize urban design and transit-supportiveness by including outdoor seating, landscaping, attractive street materials, and well-designed transit queuing areas. These measures help create an appealing street environment in the presence of high numbers of buses or trains.

In Miami Beach examples of urban avenues include Washington Avenue, Harding, Collins South of 41 Street, and Indian Creek Drive.

**TYPICAL TREATMENTS**

- 1 Large sidewalk with pavers
- 2 Dedicated transit lanes with Sheltered Platforms.
- 3 Travel way.
- 4 On-street Bike lane
- 5 Shade Trees in tree wells.



# AVENUE (URBAN)



Fig 2.5 Multi-modal commercial avenue assembly with protected bike facilities.

This is another variation of the urban avenue with fewer travel lanes, and a smaller overall width. This configuration acts as the convergence point with high pedestrian volumes in a neighborhood or district.

### TYPICAL TREATMENTS

- 1 Wide Sidewalk with Seating
- 2 Tree well
- 3 Off-street bicycle lane
- 4 On Street Parking and/ or parklets
- 5 Consistent street trees
- 6 Furnishing zone



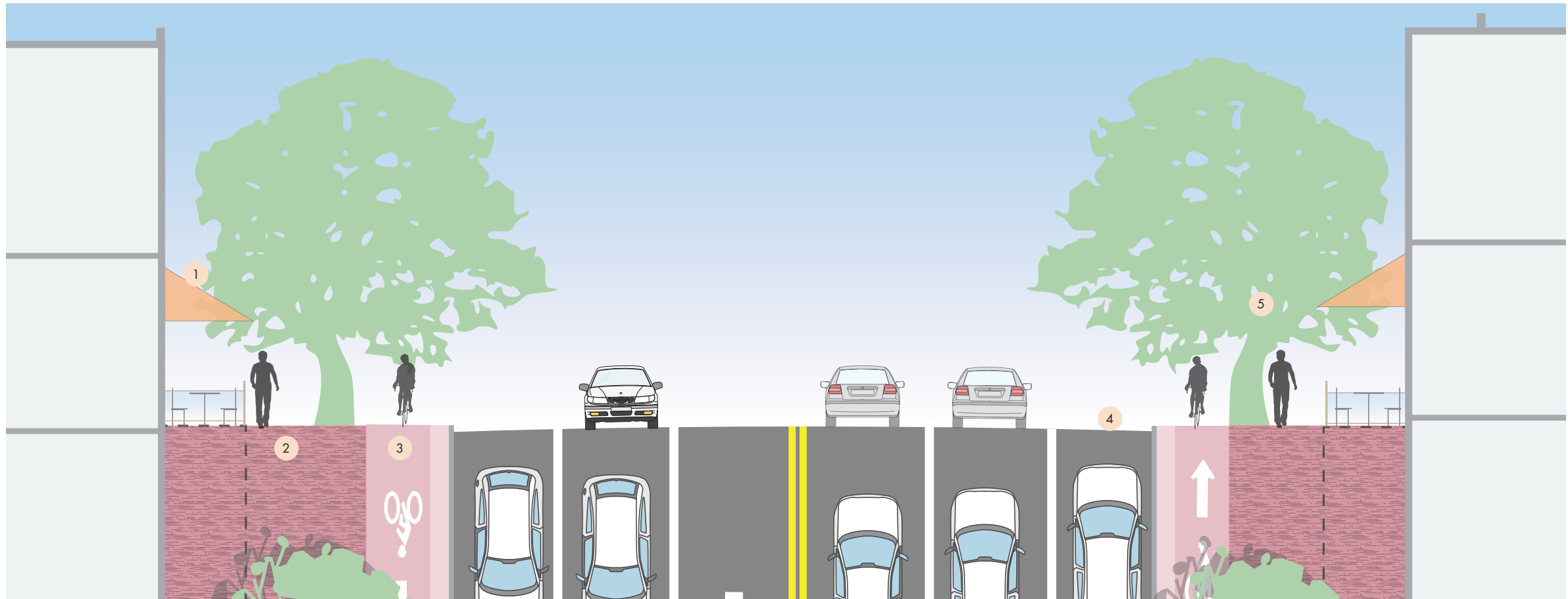

Fig 2.9 Multi-modal main street streetscape assembly with off-street bike lanes.

Main streets are urban, commercial streets that are narrow and support a high volume of pedestrian and bike traffic. Main streets support low vehicular speeds and should have on-street parking to facilitate retail success. A typical Main Street configuration allows for wide sidewalks, with street trees in tree wells, public seating in the furnishing zone and other shade structures (see streetscape section). Main streets should be equipped with adequate bicycle parking and bicycle infrastructure. Due to high activity in main streets, a protected bicycle lane and reduced posted speeds are desired.

Main Street types can be said to be the original “complete street” where tight geometry, pedestrian amenities, landscaping and minimal setbacks create a sense of enclosure that promotes healthy street life. In Miami Beach examples of Main Streets include 71 Street between Indian Creek and Collins, Harding Avenue, and 17 Street.

**TYPICAL TREATMENTS**

- 1 Building appurtenances that covered the sidewalk
- 2 Ample sidewalks with shade trees.
- 3 Off-street bike lanes.
- 4 On-street parking.
- 5 Tree wells and furnishing zone

## AVENUE (SUBURBAN)

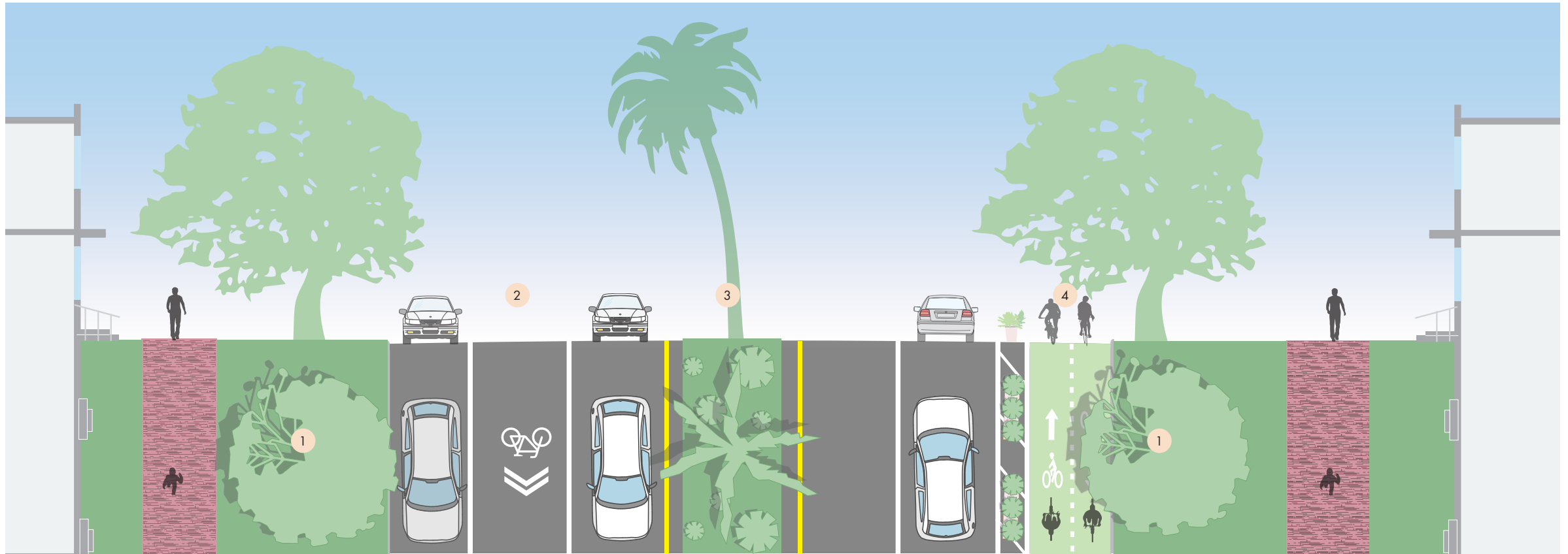

Fig 2.6 Multi-modal residential avenue streetscape assembly with protected bike facilities.

A suburban avenue is a street of low to moderate vehicular speed acting as a short distance connector between urban centers and may be equipped with a landscaped median. Suburban avenues are characterized by residential uses, with large setbacks, front yards, low to medium density buildings, and landscape strips. They should have on-street or off-street protected bike lanes or shared paths, and may have dedicated transit lanes. A challenge with suburban avenues is that they typically have many driveways. Examples on Miami Beach include Alton Road between Dade Boulevard and Chase, and Normandy Drive.

### TYPICAL TREATMENTS

- 1 A landscape strip, or swale, is used rather than a tree well. Variable number of Lanes.
- 2 A key feature is the tree lined median.
- 3 Accommodates bicycle facilities. Variable depending on R.O.W flexibility (protected)
- 4 R.O.W flexibility (protected)

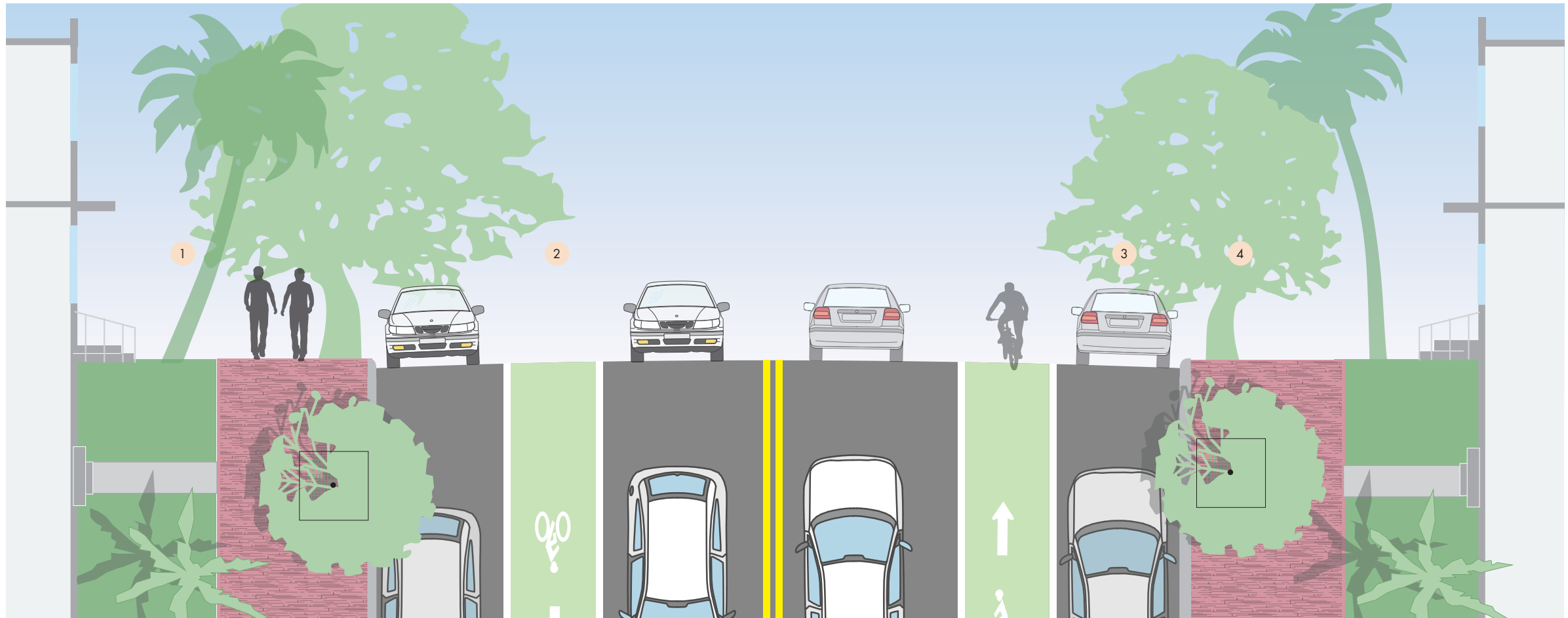

Fig 2.7 Multi-modal urban neighborhood street streetscape assembly with conventional bike lanes.

An urban neighborhood street is a local street, with low car volumes and speeds. An urban neighborhood street has raised curbs, drainage inlets, wide sidewalks, parallel parking, and trees in individual or continuous planters. Character may vary in response to the commercial or residential uses lining the street. Exemplars in Miami Beach include West Avenue, 72 Street and Byron Avenue.

## TYPICAL TREATMENTS

- 1 Character varies according to context (dooryard)
- 2 May accommodate bikeways.
- 3 Typically uses on street parking for traffic calming and pedestrian protection.
- 4 May accommodate curb extensions/ Landscape strips and furnishing zone depending on context

## NEIGHBORHOOD STREET (SUBURBAN)

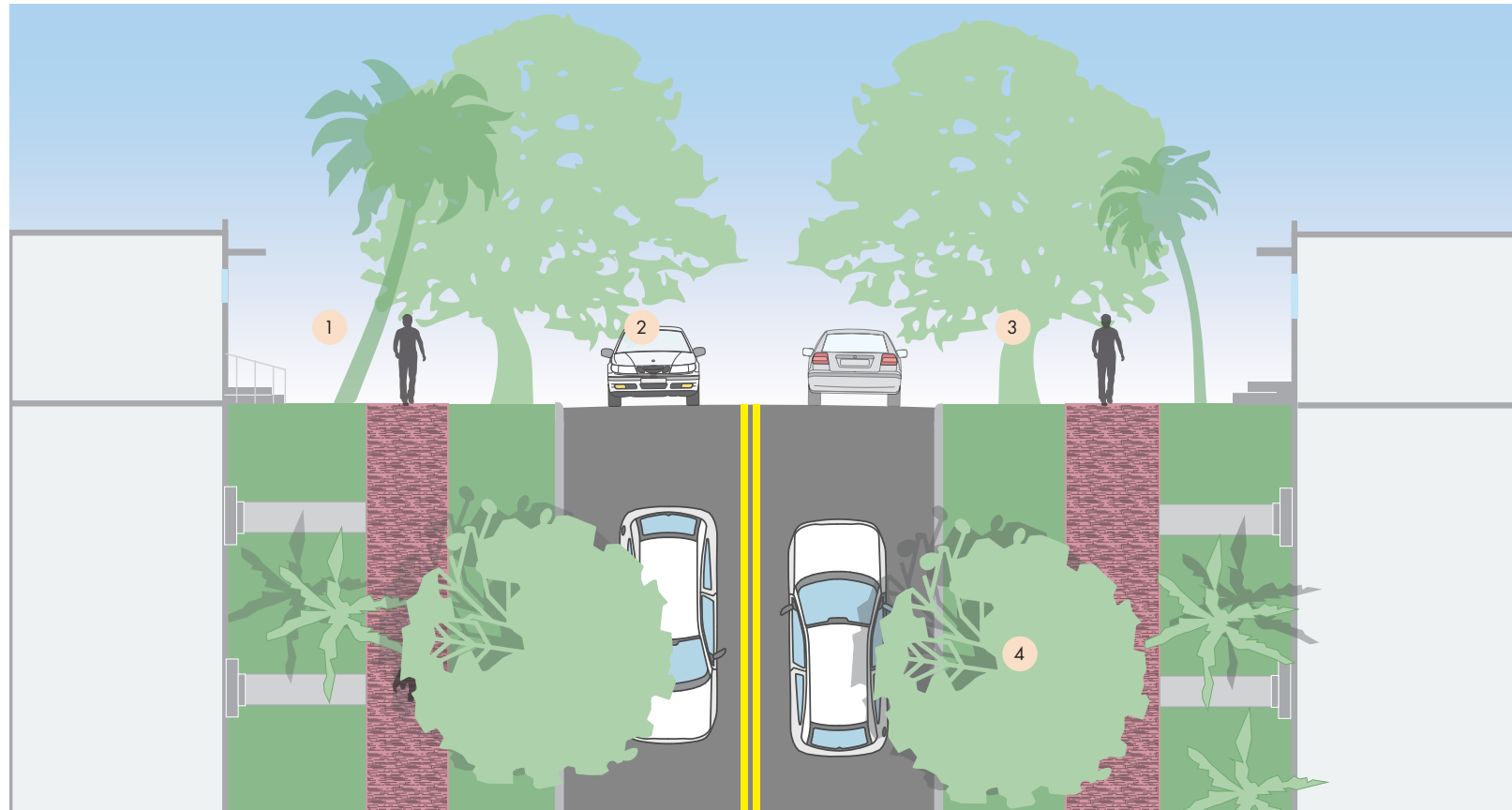

Fig 2.8 Typical neighborhood street streetscape assembly.

A neighborhood street is a local, low volume, very low speed street.. A street is suburban in character, with raised curbs (except where curbless treatments are designed), drainage inlets, wide sidewalks, parallel parking, and trees in individual or continuous planters aligned in an alley. Examples in Miami Beach include Royal Palm Avenue, Euclid, and 81 Street.

### TYPICAL TREATMENTS

- 1 Low scale residential character
- 2 May accommodate neighborhood greenways.
- 3 May accommodate curb extensions/ landscape strips/ furnishing zone depending on context
- 4 Regularly spaced street trees



Fig 2.9 Typical shared space.

Slow, curbsless street where people traveling by car, foot or bicycle share travel space equally. May support café seating, play areas, and other uses. Shared streets are designed in a way that supports all modes of transportation but gives priority to pedestrians and bicyclist while still providing access to vehicular traffic and emergency vehicles.

Shared space streets are successful public spaces that support art, entertainment and also function as commercial strips. Miami Beach currently does not have any shared space streets, though proposals have been made for Ocean Drive and Ocean Terrace.

**TYPICAL TREATMENTS**

- 1 Pedestrian Through Zone
- 2 Cafe Seating/ Furnishing Zone
- 3 Individual Tree Pits and Landscaping
- 4 Shared Roadway with Pedestrian Priority
- 5 Parallel parking (optional)
- 6 Multi-use space/ Landscape

## PEDESTRIAN STREET (NON-MOTORIZED MULTIMODAL OPTIONAL)



Fig 2.10 Typical non-motorized street (multimodal optional).

Non-motorized multi-modal streets, also known as pedestrian malls or pedestrian streets, are the most common configuration of dedicated pedestrian realm design. Pedestrian streets are lined with active store fronts, and provide a free flow of pedestrian movement throughout the space. Cafe/ restaurant seating is typically adjacent to frontage in the furniture zone.

Depending on the width of the street, pop-up shops, and vendors can be located in the middle as a temporary store front and create another through zone. Pedestrian Streets provide excellent opportunities for social interaction and arts performance. Public access to electricity should be allocated through out for musicians and other artists. Public seating should be creative and plentiful. If pedestrian/cyclist collisions are a concern due to high volumes, a designated path for bicyclist shall be designated. The use of bicycles should be allowed on pedestrian streets. However, if the right of way cannot accommodate dedicated facilities for bicyclists/rollerblades and other wheeled transportation modes, access shall be restricted during heavy traffic. Examples on Miami Beach include Lincoln Road and Espanola Way.

### TYPICAL TREATMENTS

- 1 Pedestrian Through Zone.
- 2 Cafe Seating/ Furnishing Zone.
- 3 Individual Tree Pits and Landscaping.
- 4 Mixed zone. Art/ Lawn/ Public Seating.
- 5 Consider a dedicated multi modal area.

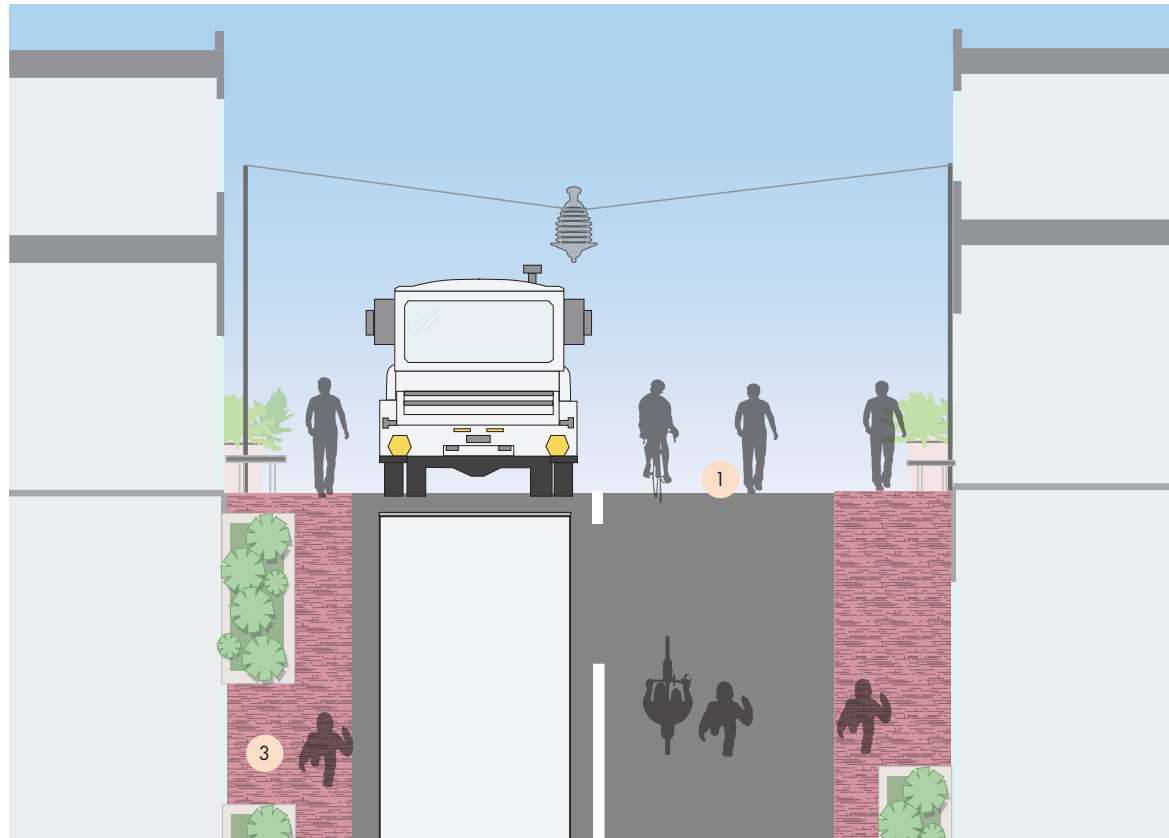

Fig 2.11 Typical commercial alley (a).

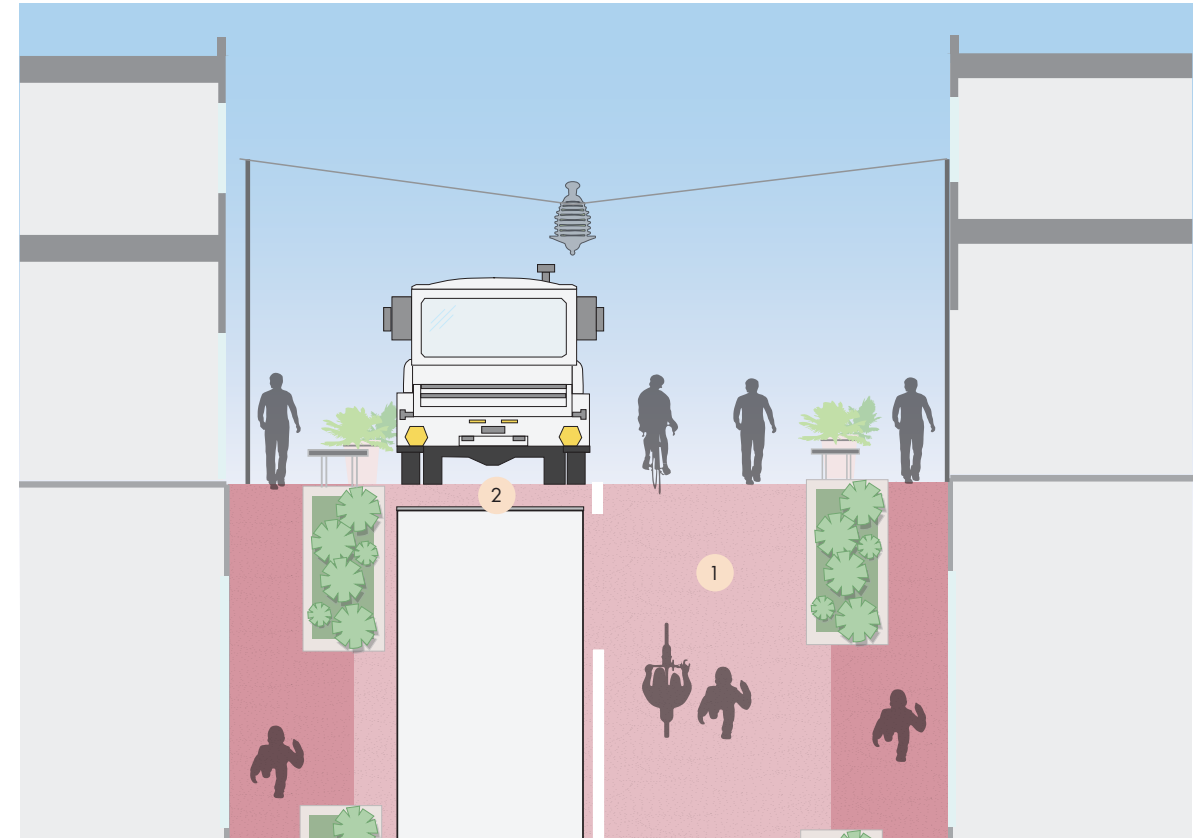

Fig 2.12 Typical commercial alley (b).

Commercial alleys have the potential to support pedestrian and bicycle connectivity. Most alleys function as loading zones during regular business hours, at all other times, alleys can be treated as shared space. It is also possible to restrict motor vehicles after delivery hours and expand cafe seating, pop-up vending and other alternative uses.

In order to successfully activate alleys for multimodal use, garbage dumpsters must be enclosed within the buildings. In addition, permanent and/or removable seating should be provided depending on right of way constrains. Human-scale lighting should be provided.

### TYPICAL TREATMENTS

- 1 Alleys can be treated as shared spaces before/after loading hours.
- 2 In low- volume loading streets, the travel way surface should be constructed with low impact materials like pervious or modular pavement
- 3 Landscaping and furnishing should be located so that it doesn't interfere with loading or unloading.







## PEDESTRIAN ORIENTED DESIGN



Conventional (auto-centric) street design relegates pedestrians to the bottom of the transportation hierarchy; overlooking the complexities of pedestrian needs like shade, comfortable places to rest, highly visible crossings, safe intersections, and wide spaces to maneuver comfortably when negotiating space with other pedestrians. Pedestrian-oriented design aims to elevate the profile of people who move about the public realm by foot or wheelchair. Countermeasures regarding pedestrians specified herein include crosswalks and other intersection details improvements, however, the streetscape section in this guide also alludes to pedestrian experience improvements. It is worth noting that all recommendations in this guide are aimed toward balancing transportation options, thus all countermeasures include guidance for the pedestrian realm at various levels.

## PEDESTRIANS: INTRODUCTION

Walking is the most basic mode of transportation. Every component of the street, from the building frontage to the crosswalks should be considered the pedestrian realm. Pedestrians including those with hearing, visual and mobility impairments are the most vulnerable of all street users. Special care and consideration is needed to identify potential issues and to design facilities accordingly.

Most pedestrian crashes occur at intersections when a person crosses the road., as such these guidelines see to address pedestrian safety at these critical locations. But to be truly walkable, streets need to have more than safe intersections, they need to be vibrant places.

One of the most common ways to maximize the amount of pedestrian space on existing roads is to narrow vehicular travel ways, and repurpose on street parking and other excess pavement areas as pedestrian space.

Narrowing travel lanes may provide extra space that can be allocated to landscaping, bikeways or to extend the furnishing zone.

In addition, narrowing travel lanes creates a visual constraint for motorist, where even though cars fit in the lanes, the narrow lanes force motorist to negotiate space with each other, thus reducing travel speed and increasing pedestrian's level of safety.

Figure 2.14, the Pedestrian Priority Matrix, shows the four most common safety and comfort challenges facing pedestrians, along with short and long term answers to these problems.

### PEDESTRIAN ENVIRONMENT

The pedestrian environment is commonly made up of four different zones:

#### THE FRONTAGE ZONE (1)

The zone immediately adjacent to the buildings. Depending on regulations, businesses may use this area as an extension of their shop for small displays where space allows, appurtenances like awnings and signs.

- This area shall be kept narrow.
- Paving material should match the through zone material but an accent color may be used to highlight the edge of the space.
- This area shall provide shade to pedestrians in the form of awnings or street trees with large canopy located on the edge.

#### THE THROUGH ZONE (2)

As the name describes, this is the main area for people who walk.

- This area shall be free of obstacles.
- Paving shall be slip resistant and even.
- This area shall be as wide as possible where foot traffic is most likely to occur, but always be wide enough for wheelchairs and parents with strollers so as to provide a comfortable space for people on foot to walk along other users.

#### FURNISHING ZONE (3)

This area shall accommodate aesthetically pleasing street furniture, including seating, utility equipment, sidewalk cafes, landscaping and kiosks.

The furnishing zone shall:

- Have all elements clearly defined by a coherent layout that maximizes public space.
- Provide through access for pedestrians at various points.
- Efficiently accommodate transit stops and bicycle parking in an aesthetically pleasing manner.

#### EDGE ZONE (4)

This is the zone adjacent to the travel ways. It provides a safe transitional space for cars parked along the street to open doors. Street signs, and light posts are usually placed here on most streets.

Edge zones shall:

- Combine furnishings zone and edge zone where necessary for transit stops and taxi waiting zones

Fig 2.13 Pedestrian realm.

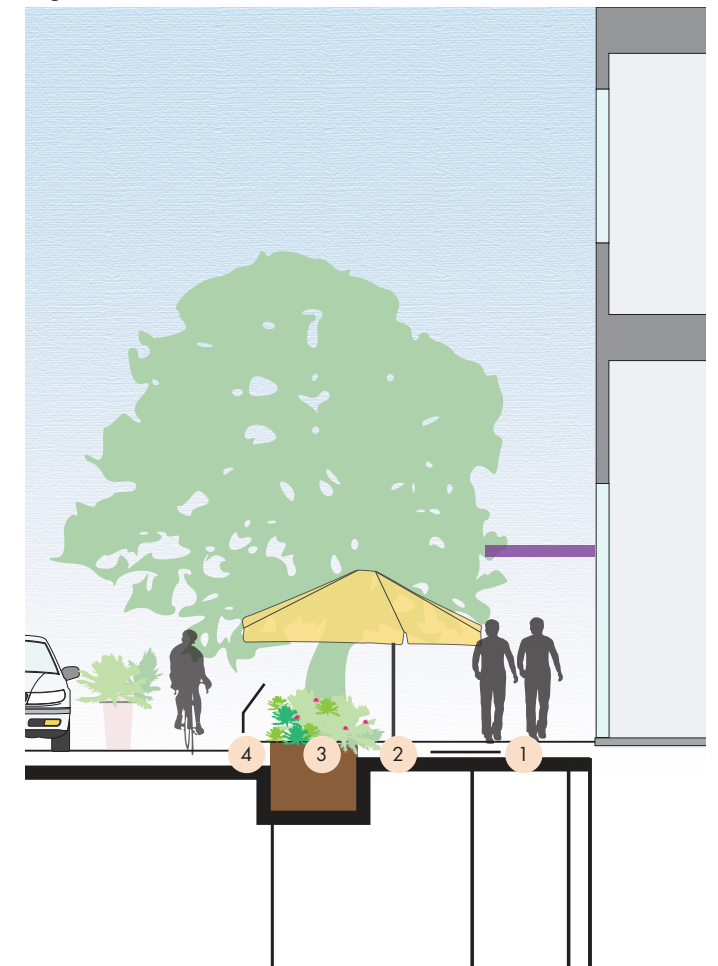

The pedestrian environment is defined by the two most common boundaries we encounter as pedestrians on the street: The property line and the curb. The pedestrian environment can also be conditional. Pedestrians might occupy the entire street during festivals, bicycle days, block parties and markets.

NEIGHBORHOOD STREET SIDEWALK CONSIDERATIONS:









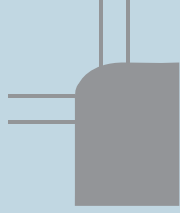

Neighborhood streets are recommended to be built to the current adopted standard, with a six-foot sidewalk and a four-foot Furnishing Zone. The 6' sidewalk provides adequate passing space for the typical volume of pedestrian traffic on a residential street, and the 4' buffer can sustain trees and other amenities and offers a comfortable buffer from low-speed, low-volume vehicular traffic, which is desirable on such streets.

URBAN AVENUES AND BOULEVARDS CONSIDERATIONS

Boulevards and urban avenues have moderate to high-speed motor vehicle traffic and require a wider buffer between pedestrians and moving vehicles to maintain pedestrian comfort. A five-foot Furnishing Zone is recommended. Because such streets may have significant commercial activity and multiple destinations, it is recommended that the width of the sidewalk be increased to a minimum of 8' to accommodate a larger volume of pedestrians.

MAIN STREET, PEDESTRIAN STREETS, SHARED SPACE CONSIDERATIONS:

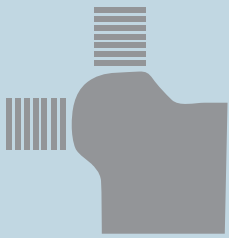
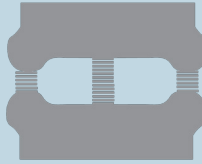
Due to the high volume of pedestrian activity expected on these streets sidewalks must be wide enough to support a variety of activities in addition to walking. The furnishing zone shall provide benches, bicycle parking and tree wells. A frontage zone is required for this category of street, providing space for product display, cafe seating, or room for people to stand without blocking the through zone. The width of the frontage zone may vary depending of density and space availability but its recommended to be at least 5 feet.

|            | INTERSECTIONS   | CROSSINGS  | CAR SPEED   | WEATHER   |
|------------|---|--|---|---|
| CHALLENGE  |  <p>Poor Visibility, high turn speeds</p>  |  <p>Limited crossings, lack of signal priority and time for pedestrians to cross</p>                  |  <p>Cars Speed down neighborhood streets between signals and stop signs.</p> |  <p>Heavy rain seasons, lack of shade</p>  |
| SHORT-TERM |  <p>Paint crosswalks at all intersections.</p>   |  <p>Increase signal timing for pedestrians, expand exclusive pedestrian phase, inspect signals to</p> |  <p>Reduce posted speed to 20 mph or less *</p>                              |  <p>Increase tree canopy with movable planters; expand shade tree plantings (rather than palm trees)</p> |
| LONG-TERM  |  <p>Install textured crosswalks &amp; narrow curb radii at all intersections to less than 20'.</p> |  <p>Implement mid-block crossings and curb extensions</p>   |  <p>Reduce design speed. Implement Play Streets. **</p>                    |  <p>Improve frontage; require shading devices on buildings in zoning requirements</p>                  |

\*The "Children At Play" sign represents the implementation of "play street" policies "Play Streets" is a program where chosen streets are temporarily closed to vehicular traffic and activated for pedestrian use focusing on children. Refer to <http://ahealthieramerica.org/play-streets/play-streets-full/> for more information.

Fig. 2.14 Pedestrian Priority design matrix.

## PEDESTRIAN PRIORITY ZONES

### PEDESTRIAN PRIORITY ZONES (PPZ)

Pedestrian Priority Zones are those locations in the city where a district-wide approach to pedestrian safety is desired, both because of existing and future demand. Although a complete Pedestrian Priority Zone is made up of a variety of elements, PPZs are defined as a continuum of approaches ranging from a complete sidewalk network in residential neighborhoods to robust intersections that enhance the safety of pedestrian crossings.

Those areas in Miami Beach where the combined pedestrian and transit mode share is higher than 40% shall be considered Pedestrian Priority Zones, and follow the following more stringent requirements to facilitate safe pedestrian street and intersection design.

- Provide continuous, unobstructed sidewalks with a clear width of 6 feet minimum (1)
- Curbs aligned with ramps and sidewalks. (2)
- All intersections have visible crosswalks of 10 feet in width.
- Longer crossing signals times in consideration of elderly and handicap users. The average estimated crossing time for the elderly men being 3ft per second, and elderly women 2.5 feet per second.
- Travel lanes have a reduced width of 10 feet. (3)
- Provide curb extensions (bulb-outs) at intersections on all arterials.
- Provide crossings at intervals not to exceed 350'
- Provide regularly spaced, pedestrian scale lighting.
- Require Shade trees on all sidewalks. (4)
- Provide shade structures on sidewalk and in building frontage.
- Prohibit right turns on red. Provide green signal turn.
- Provide exclusive pedestrian phase at intersections where the volume of pedestrian crossings is greater than X pedestrians per minute.
- Limit speed limits to 25 mph max, preferably 20mph; ensure consistent design speed for streets. (5)

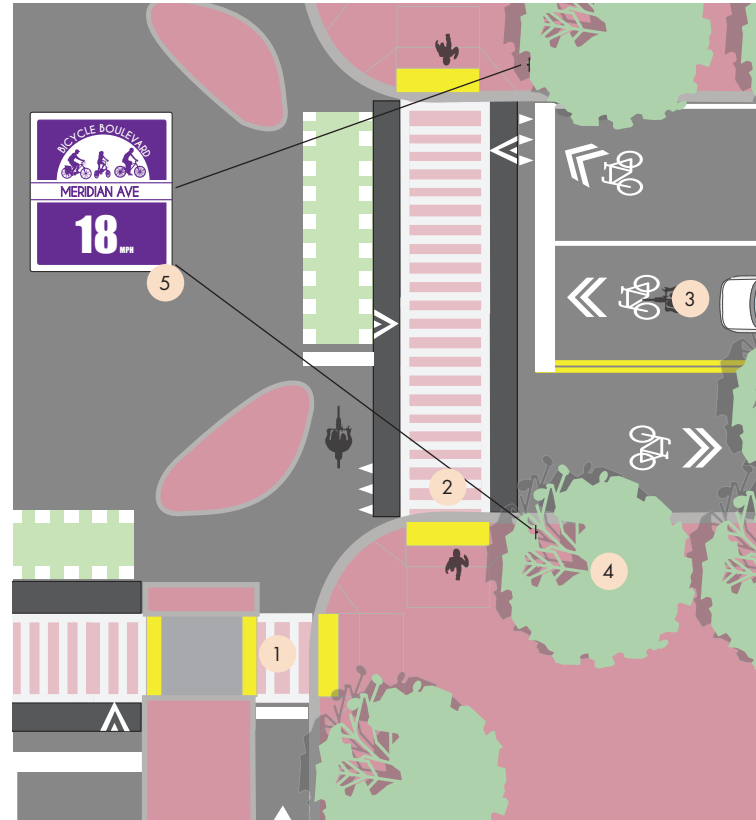

Fig. 1.5 Example of elements of a pedestrian priority zone.

#### DESIRE LINES/ DESIRE PATH

Pedestrians and bicyclists will always find ways that increase efficiency of travel. Desire lines are those unprescribed paths taken by users of the public realm. These paths shall be analyzed and implemented where possible in order to enrich the pedestrian experience through observation of users.

#### MOVING TOWARDS PEDESTRIAN PRIORITY

Pedestrian Priority Zones should be considered economic development tools for the city by allowing for increased pedestrian traffic in shopping districts without the need for parking.

#### EXTENSION OF 20 MPH ZONES:

Vehicles traveling at this speed present a “greatly reduced risk” of accidents. Driver/pedestrian visibility is higher at slow speeds. These zones can be implemented in local streets with relatively low-traffic and most collector streets depending on context.

#### MEETING/ MIXING/ CONVERGENCE ZONES:

This zones have an even lower speed limit of 15 mph. Pedestrians are given absolute priority of the roadway at all times, even if sidewalks exist, followed by bicyclists and motor vehicles.

#### STREET MARKINGS, CROSSINGS AND SIGNAGE:

Different markings on pavement as well as signage can alert users about the Pedestrian Priority Zone.

#### SIDEWALKS

Ample, connected sidewalks are at the core pedestrian mobility and ADA compliance. The following steps should be taken in order to attain Pedestrian Priority Design:

- Assessment: Conduct sidewalk surveys every 2 years to maintain and update the inventory of sidewalks, their state of repair, crosswalks, pedestrian signals.
- Fill in the gaps: Prepare a phasing “sidewalk priority index” plan for the introduction of

INTERSECTION CROSSINGS + CURB RADIUS

Pedestrian crossings shall be provided at all intersections and shall be spaced no greater than 350' apart. Corner radii should be no greater than 25 degrees to encourage slow turning movements for automobiles, and shorter crossing distances for pedestrians, as shown in Figure 2.15 below.

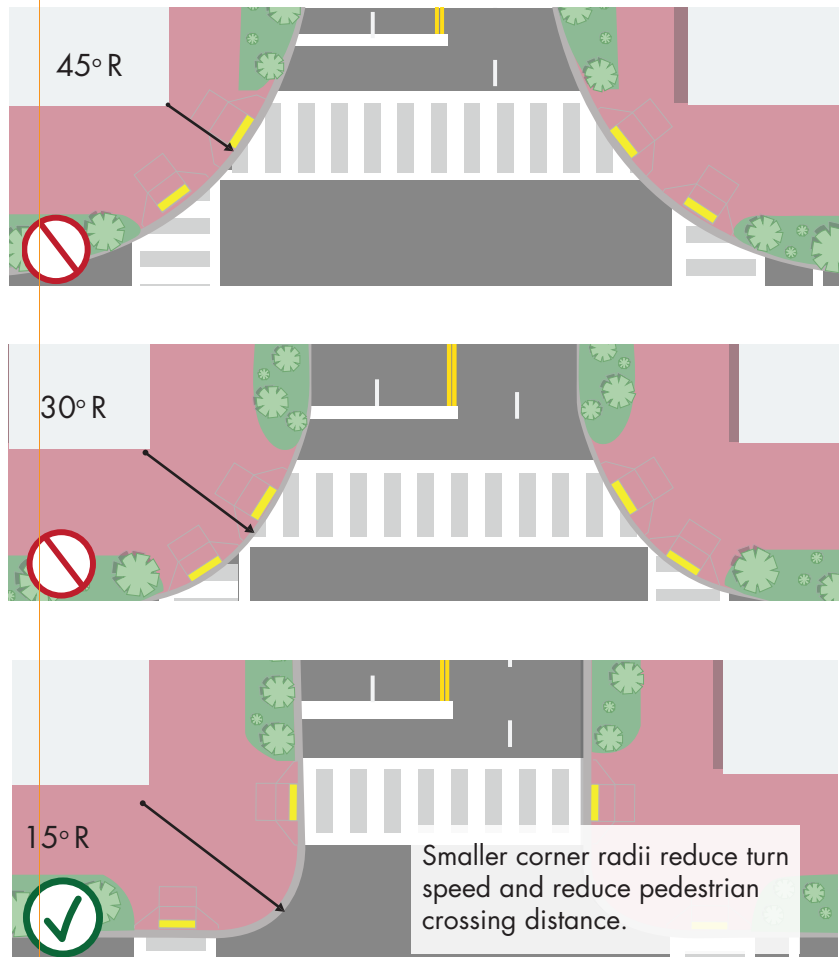

Fig. 2.15 Corner radii and pedestrian crossing safety. Tighter turning radii are challenging for freight trucks and large passenger trucks, but should be used in pedestrian priority zones.

BULB OUTS

Bulb outs, also known as curb extension, are a common technique that extend the sidewalk, reduce the crossing distance for pedestrians, and provide additional green space.

Their use in Miami Beach has been controversial due to lack of public support, difficulty in maintaining landscape areas, and conflicts with large vehicles negotiating the tighter curb radius.

One way of addressing community concerns about curb extensions while still providing them is to install mountable curb extensions, as detailed in section x-x.

Extending the curb moves parallel parking away from the intersection and increases the sight triangle for motorists while also reducing pedestrian crossing distances across the intersection.

Curb extensions are the desirable configuration. This configuration improves visibility for all users and provides an opportunity for storm water management that is also aesthetically pleasing.

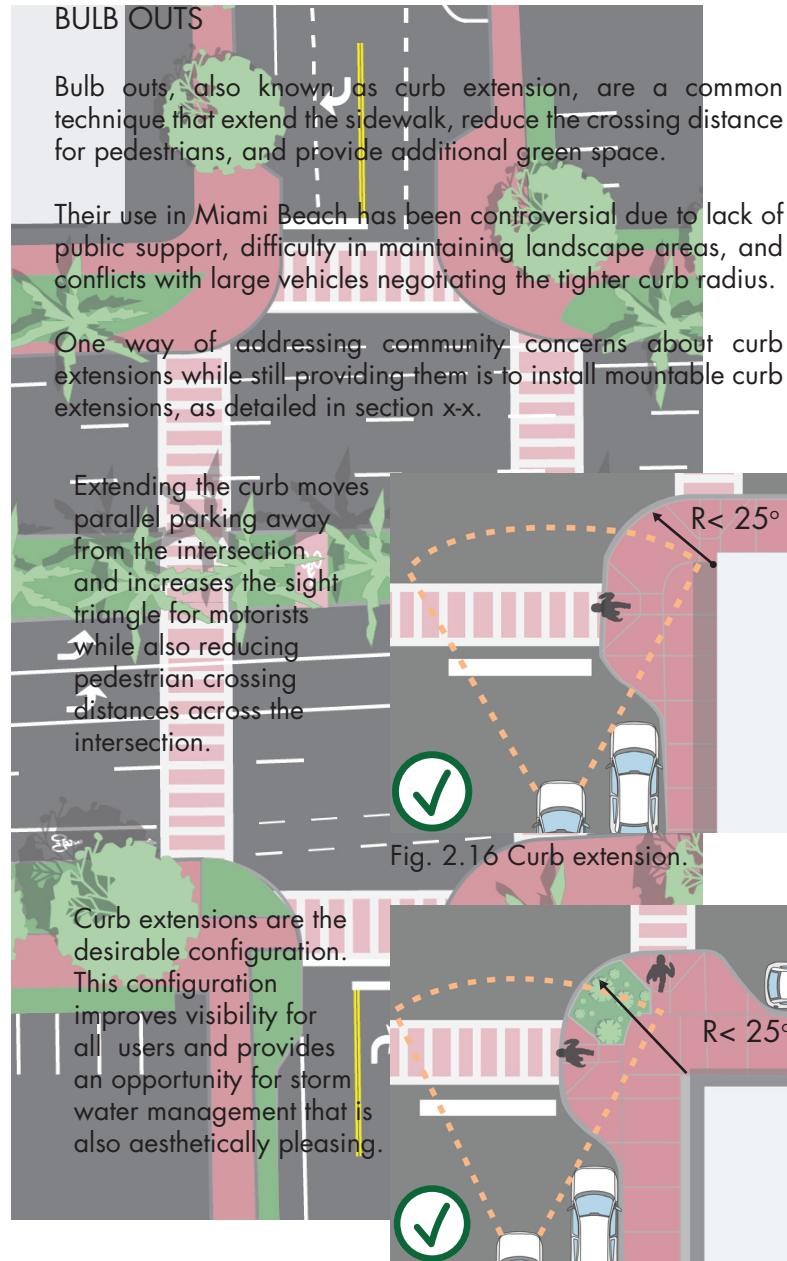

Fig. 2.16 Curb extension.

Fig. 2.17 Curb extension with landscaping.

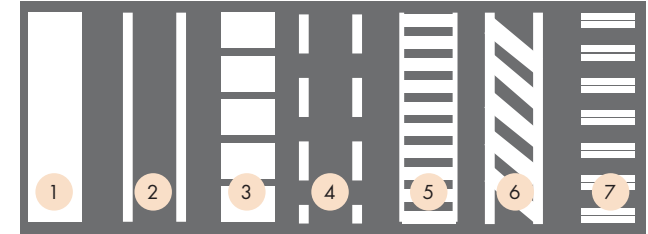

Fig. 2.21 MUTCD approved types of marked crosswalks

- 1 Solid Crosswalk
- 2 Standard Crosswalk
- 3 Continental Crosswalk (preferred)
- 4 Dashed Crosswalk
- 5 Zebra Crosswalk (preferred)
- 6 Ladder Crosswalk (preferred)
- 7 Piano key style (preferred)

MARKED CROSSING F.A.Q

- Consider treatments around schools and high crossing areas.
- Resurfacing projects.
- Piano key style crossings have a lower maintenance cost over other high visibility crosswalks due to reduced friction.
- Marked crosswalks are not necessary for every intersection. Marking a crosswalk must be looked in conjunction with possible road diets and other countermeasures.
- Retroreflectivity in high visibility crosswalks require 6 pounds of glass beads per gallon of paint



# PEDESTRIAN: CROSSINGS

## CROSSWALKS

Crosswalks are the designated part of a roadway at an intersection or elsewhere where pedestrians are intended to cross, indicated by surface pavement markings or materials. Even where crosswalks are not marked, pedestrians can legally cross the street according to state law.

The MUTCD Section 3B.18 offers general guidance for site-specific crosswalk marking implementation which call special attention to the areas where it is believed pedestrians should cross the street, and where existing volumes of pedestrians are high. However, pedestrian behavior often disregard these cues, and choose to cross at the shortest distance regardless of the presence or absence of paint. In addition, the standards set forth herein are intended to increase the pedestrian modeshare, and are to be implemented regardless of existing pedestrian demand.

Data shows that high visibility crosswalks have numerous benefits. In New York City, they are associated with a 40% decrease in pedestrian crashes, while in San Francisco a 37% decrease in crashes was observed in school zones with marked crosswalks.\*\*

Marked crosswalks are provided for a variety of reasons:

- To indicate to pedestrians the desired path of crossing.
- To alert motorists of the presence of pedestrians at intersections.
- To indicate a legal mid-block crossing for pedestrians in high volume, high crossing areas.

WHEN SHOULD MARKED CROSSWALKS BE PROVIDED?

- At intervals no less than 350'
- At locations controlled by traffic control signals
- At intersections controlled by stop or yield signs.
- Where judgment dictates the need of a marked crosswalk because of high demand, or to indicate safest path.

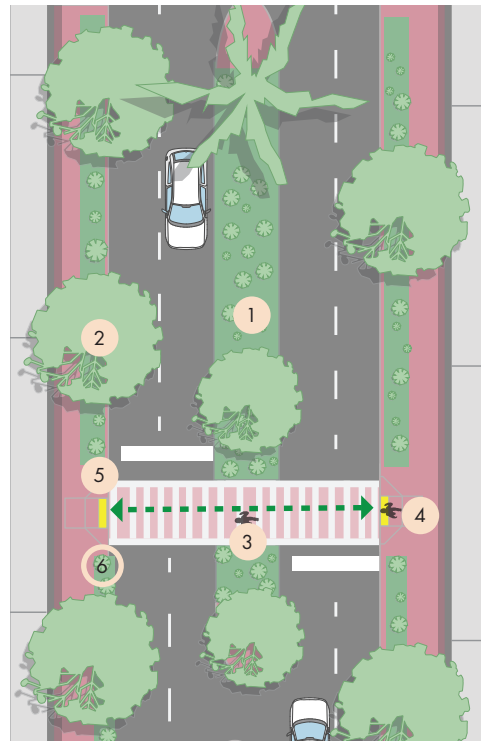

Fig. 2.18 Pedestrian Mid-block crossing.

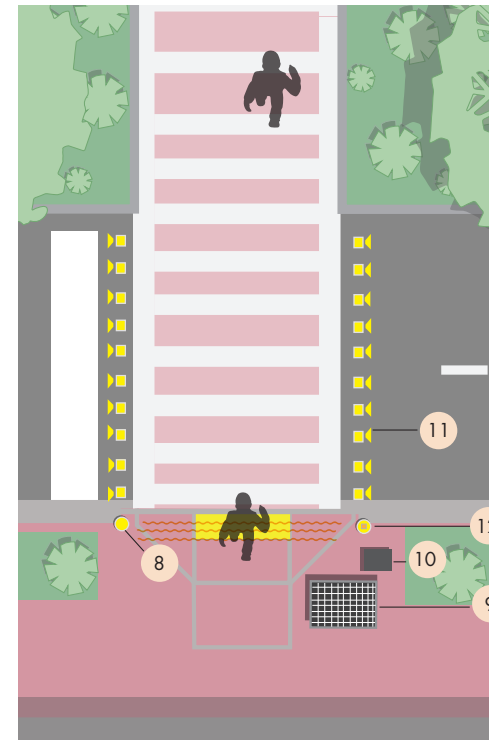

Fig. 2.19 In pavement beacons

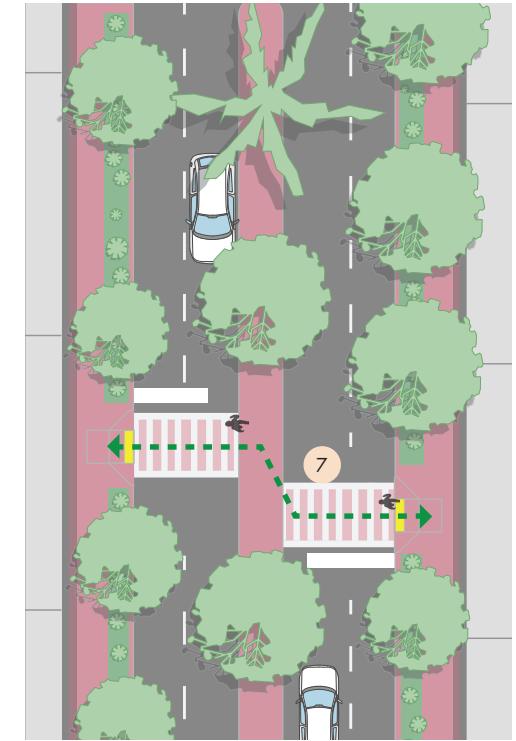

Fig. 2.20 Offset pedestrian mid-block crossing.

### TYPICAL TREATMENTS

- 1 Raised Median/ Nose
- 2 Street Trees
- 3 Raised/High Visibility Crosswalk
- 4 Curb ramps
- 5 Audible/Dynamic pedestrian signals
- 6 Solar RRFB pedestrian flashing beacon (optional)
- 7 Offset crosswalk forces pedestrians to face oncoming traffic before crossing.

- 8 Automatic sensor to activate crosswalk (optional)
- 9 Solar cell panel or AC powered
- 10 Control unit
- 11 Embedded amber LED strobe lights (can be seen 1,500 feet away)
- 12 Push button crosswalk activator (optional)

### MID-BLOCK CROSSINGS

Mid-block pedestrian crossings shall be based on frontage access and pedestrian movement desire lines.

- They shall be well marked and include overhead signage
- Provide curb extension where there is on-street parking to enhance pedestrian visibility.
- Provide raised crossings at high traffic areas.



## BICYCLIST - ORIENTED DESIGN



Bicyclists currently make up 5% of all trips in Miami Beach, a number that is expected to double over the next fifteen years. Bicyclists should be anticipated to use all streets in the city, whether they have designated facilities or not. Bicycle facilities may be provided in the form of grade-separated bike lanes, shared paths or as on-street protected bicycle lanes or low-stress greenways. Bike lanes, on and off sidewalk-level and paths occupy a defined space painted in a predetermined color, whereas greenways do not physically separate bicyclists from drivers, though they may be marked with sharrow and other markings to indicate bicyclist priority.

Bicycle facilities are highly adaptable to various Right-Of-Way constraints, as detailed in the pages ahead. Designated bikeways successfully separate pedestrians from bicyclists and make them more visible to people traveling by car. The average constant speed varies from 10 - 18 mph which means that a 5 mile trip takes a bicyclist about 25 minutes to complete, this is the equivalent of a typical commuter trip.

# AN INTRODUCTION TO BICYCLES: TYPICAL BIKEWAY FACILITIES

The language of bicycle facilities and countermeasures has grown substantially over the past 20 years. What follows is a synopsis of the facility types most appropriate for Miami Beach. Standards and more information on each is found in the pages that follow.



**NEIGHBORHOOD GREENWAY - HEAVY**

A street where bicyclists share the road with low volume, low speed car travel, less than 300 VPD and 18 mph. It needs substantial traffic diversion, traffic calming, and coordinated signage.



**BIKE LANE**

A lane reserved for bicycle travel within a thoroughfare, marked by a painted line. It is not protected from vehicular traffic with physical barriers (bollards, medians, raised curbs). Often distinguished with green paint.



**SHARED USE PATH**

A path or trail is physically separated facility from motor vehicular traffic with an open space or barrier. Allows for mixing of non-motorized travel and pedestrians while still being separated from motorized travel lanes.



**BIKE SIGNALS**

A section of pavement aimed at preventing bicycle/car collisions at intersections, particularly between drivers turning right and cyclists traveling through an intersection within an existing bicycle lane. To improve



**NEIGHBORHOOD GREENWAY - LIGHT**

A street where bicyclists share the road with low volume, low speed car travel (less than 300 VPD and 18 mph). It needs fewer traffic diversion than Neighborhood Greenway Heavy.



**CONTRAFLOW BIKE LANE**

A designated bicycle Lane marked to allow bicyclists to travel against the flow of traffic. Provides connectivity and access for bicyclists traveling in opposite direction of automobiles.



**PARKING PROTECTED BIKE LANE**

Bicycle Lane, either at grade or grade separate, protected from motor vehicle travel lanes by Curbs, railings, plantings, parked cars, and/or grade separation, etc.



**BIKE BOX**

A bicycle box is an intersection treatment that places the bicyclist in front of motorists and is aimed at preventing collisions between turning drivers and cyclists.



# NEIGHBORHOOD GREENWAYS & BICYCLE PRIORITY CORRIDORS

## ESTABLISHING BICYCLE PRIORITY CORRIDORS

Bicycle travel is efficient, environmentally sustainable and can accommodate a variety of users depending on ability. The 2016 Bicycle Pedestrian Master Plan establishes a network of bicycle priority corridors that each are calibrated to a different context.

Miami Beach has a mix of leisure and commuter bicyclists at all times. Providing infrastructure for bicyclists is crucial to the success of Miami Beach as a multi-modal city.

The following are characteristics of Bicyclist Priority Corridors:

- Bicyclist Priority corridor signage along routes promotes slower motor vehicle speeds to encourage leisure riding as well as commuting for all users.(1)
- Designated areas are in proximity to transit
- Require Street trees/ Shade trees/ Shade structures on sidewalks.
- Crossing signals with enough time for crossing safely.
- Travel lanes have a reduced width of 10 feet.
- Provide bike boxes and turn boxes at all intersections.(2)
- Provide bike repair stations along route.
- Provide green signal turn and bike signals at major intersections.
- Reduce travel speed to 20 mph or less where bikes are sharing the road with traffic.
- Provide short and long-term bicycle parking along route/ zone. Implement short term bike valet for special events. (3)



## MOVING TOWARDS BICYCLE PRIORITY

A true shift on modeshare can only be accomplished successfully through street design that reflects the needs of all types of bicyclists. A bicycle priority corridor is one that elevates the profile of people traveling by bike making the streets safer and more pleasant for all users.

The City can begin moving towards bicycle priority zones by implementing the following policies for corridors listed in the bicycle pedestrian master plan.

- **RIGHT ON RED FOR BIKES ONLY:** Right on red turns should be allowed for bicyclists only. This helps bicyclists to keep momentum. Also, in zones of 15 mph - 18 mph bicyclists can go straight on red provided it is safe to do so. Idaho stop law (HB 541) sets precedent allows cyclists to treat a stop sign as a yield sign, and a red light as a stop sign since 1982.
- **CLEAR DESIGNATION OF SPACE:** Painted bike lanes designate clear separation of use within the travel lane. Protected bike lanes increase safety and perception of safety for bikers resulting in higher ridership numbers.
- **SIGNAGE:** Sharrows, bike priority designation markings and other signage is a good first start in identifying bicycle priority corridors.
- **PARKING:** Provide ample covered bicycle parking. Legalize bike parking on signs and other vertical elements.





## NEIGHBORHOOD GREENWAYS & SHARED STREETS



These types of facilities are implemented on streets with medium-low to low vehicle traffic like neighborhood/ local streets. Greenways will have a variety of traffic calming and diversion strategies that aim to control speeds, limit conflicts among users and give priority to bicycles while providing a safe and attractive environment for pedestrians.

Greenways function best as a network rather than isolated, this way, all types of bicyclists can navigate the streets safely and efficiently

Shared road facilities fall in a continuum of minimal (light) to heavy physical intervention, therefore implementation and cost vary commensurate with the level of intervention.

# BICYCLIST: NEIGHBORHOOD GREENWAYS: INTRODUCTION

Neighborhood Greenways are streets where bicycle travel is given priority. These are often defined by strategies that are applied to neighborhood streets to enhance the experience of pedestrians and bicyclists of all ages and skills levels, while still providing vehicular access. There is no one standard for how to implement a neighborhood greenway, but rather they are made by combining any traffic reducing/calming element that lowers vehicular traffic and enhances the bicycle and pedestrian experience.

Neighborhood Greenways should meet the following criteria:

- Reduce vehicular cut-through by installing traffic diverters to under 700 VPD .
- Provide safer bicycle and pedestrian connectivity by implementing pavement markings, route signage and enhanced crossings for pedestrians and bicyclists.
- Reduce vehicular speeds, by installing speed cushions, speed bumps and reducing posted speeds to 18 mph.
- Guide people along route by providing signage indicating nearby amenities like the beach, parks, libraries and commerce. (Consider signs that include average riding distance/ time to destination)
- Increase the amount of tree canopy through the use of street trees on both sides of the street at every 25' on center.

The key to designing Neighborhood greenways that work is to design for the lowest amount of stress you can feel as a rider. Lowering traffic stress requires neighborhood greenways to operate with low auto volumes and speeds, provide protected crossings at major intersections and maintain an environment that encourages people of all ages and abilities to travel actively. They rely on a combination of trees and traffic calming measures that discourages cut-through traffic to lower the traffic stress on neighborhood greenways for people walking and biking.

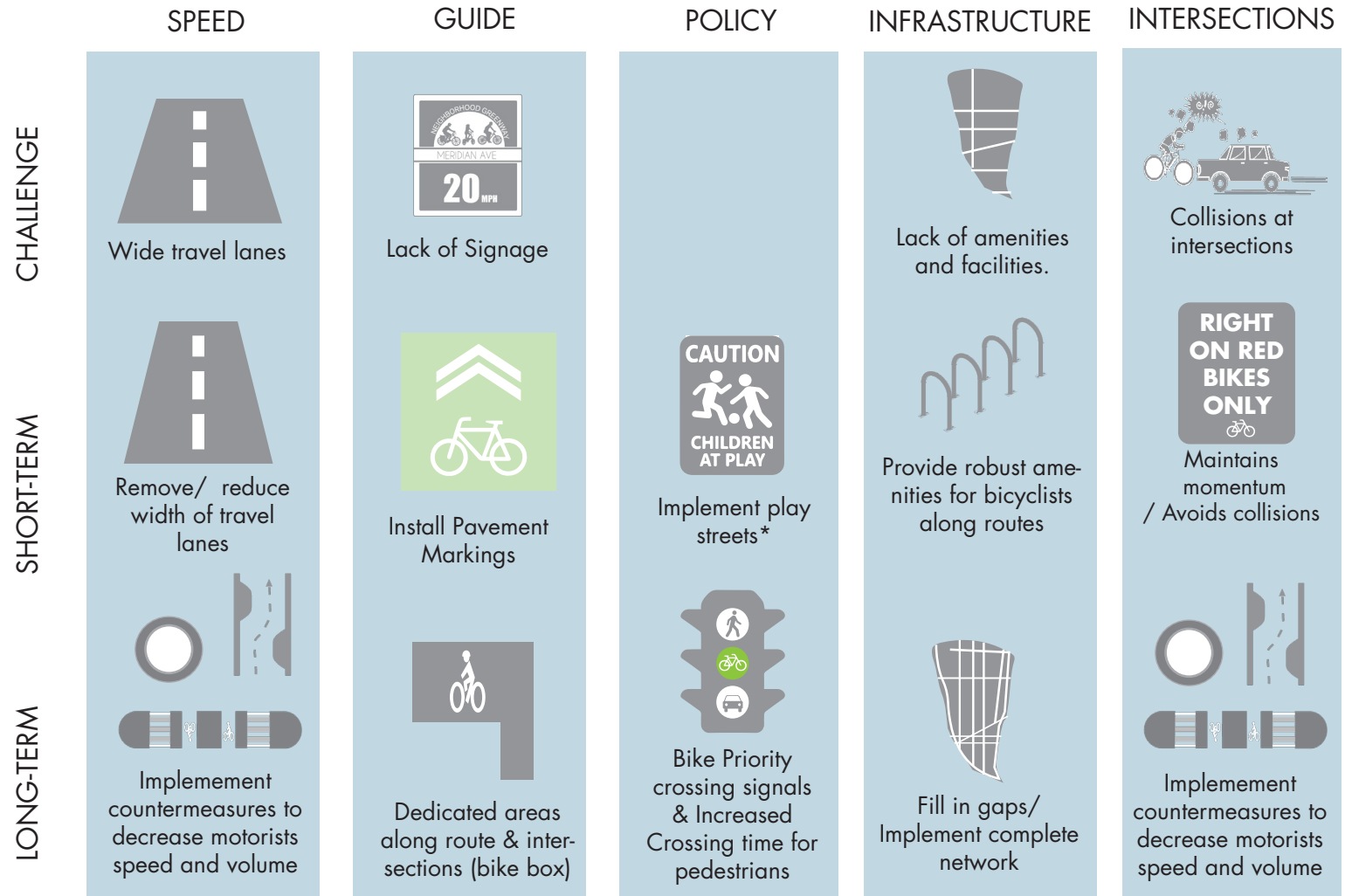

Fig. 2.22 Bicycle Priority Corridor design matrix.

\*The "Children At Play" sign represents the implementation of "play street" policies and urban design countermeasures in order to achieve a pedestrian priority zone; not the installation of non-approved MUTCD "Children At Play" signs along residential streets. Play Streets" is a program established by the Partnership for Healthier America and the First Lady Michelle Obama in 2012. Chosen streets are temporarily closed to vehicular traffic and activated for pedestrian use focusing on children. Refer to <http://ahealthieramerica.org/play-streets/play-streets-full/> for more information.



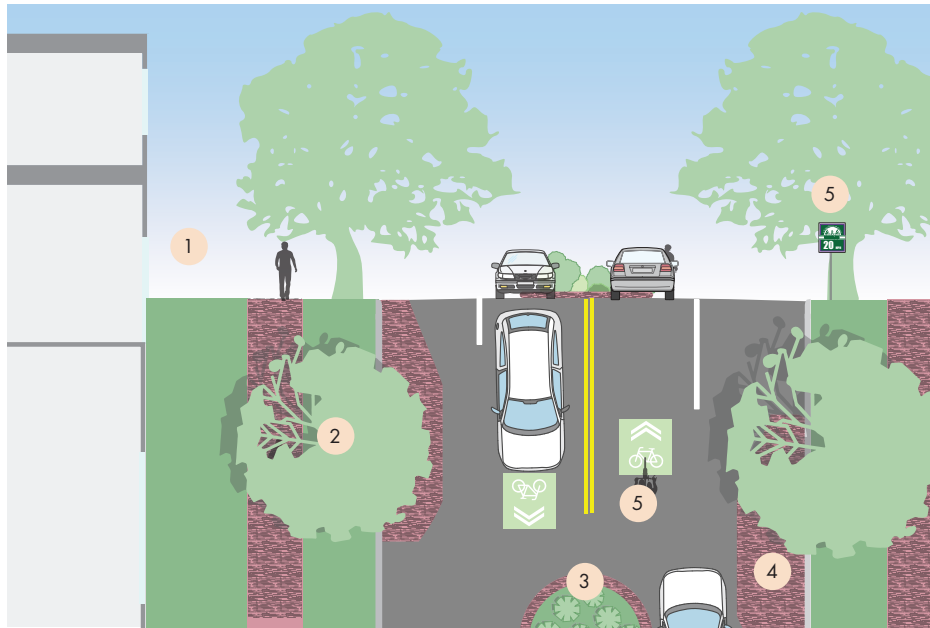

Fig 2.23 Typical "Heavy" Neighborhood greenway.

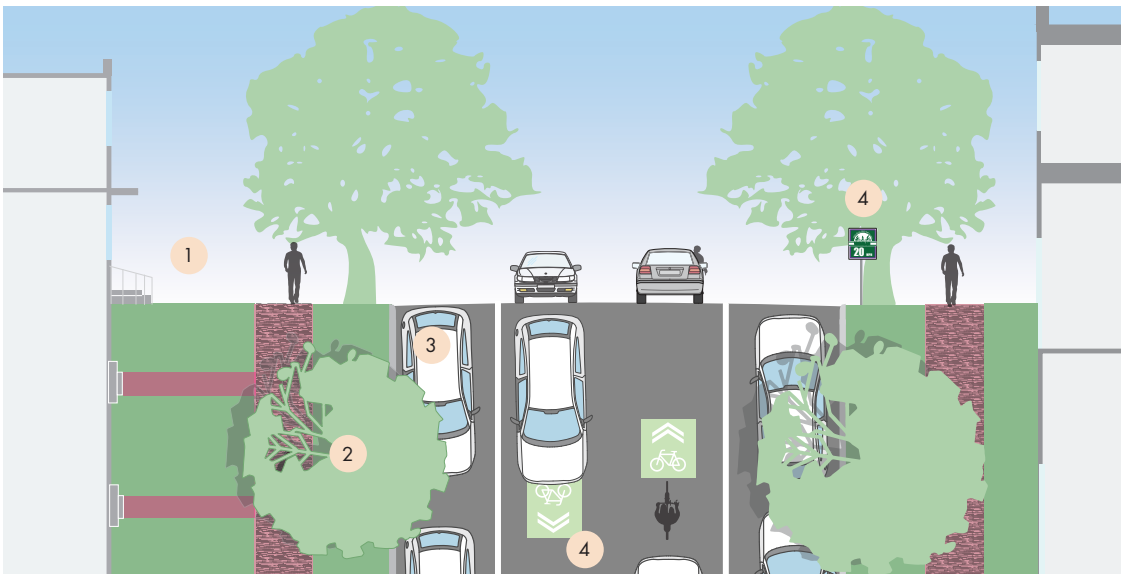

Fig 2.24 Typical "light" Neighborhood greenway.

Neighborhood Greenways are local streets that serve as "bicycle priority streets". They have less than 1,500 VPD and no more than 20 mph. There are two types of neighborhood greenways which vary based on desired level of traffic calming and bicycle priority.

## NEIGHBORHOOD GREENWAY - HEAVY

A "heavy" neighborhood greenway is a street where the volume of traffic that usually presents elements like: Neighborhood circles, chicanes and other countermeasures for volume and speed management that require construction, and physically change the existing streetscape. Neighborhood Greenway Heavy streets are usually over 1,500 and must bring their numbers to be lower than 800 VPD to meet Neighborhood Greenway Designation.

### TYPICAL TREATMENTS

- 1 Residential context
- 2 Extensive Tree Canopy - shade trees at 25' oc minimum/ Landscaped Swales.
- 3 Substantial traffic diversion through the use of neighborhood-scale traffic circles, and turning diverters.
- 4 On-street parking/ chicanes and edge islands encouraged as traffic calming and pedestrian protection.
- 5 Clear signage and posted speed limits shall be present consistently align route and at junctions

## NEIGHBORHOOD GREENWAY - LIGHT

Neighborhood Greenways that are referred to as "light" tend to already have low traffic (less than 300 VPD), and usually require minimal intervention or construction. Lite neighborhood greenways should be implemented through a combination of signage, pavement markings, re-stripping and minor intersection traffic calming measures.

### TYPICAL TREATMENTS

- 1 Residential context or light commercial.
- 2 Extensive Tree Canopy - shade trees at 25' oc minimum/ Landscaped Swales.
- 3 On-street parking, chicanes and edge islands encouraged as traffic calming.
- 4 Clear signage and posted speed limits.

# BICYCLIST: NEIGHBORHOOD GREENWAY (HEAVY)

Fig. 2.25 Neighborhood Greenway Heavy to Light continuum.

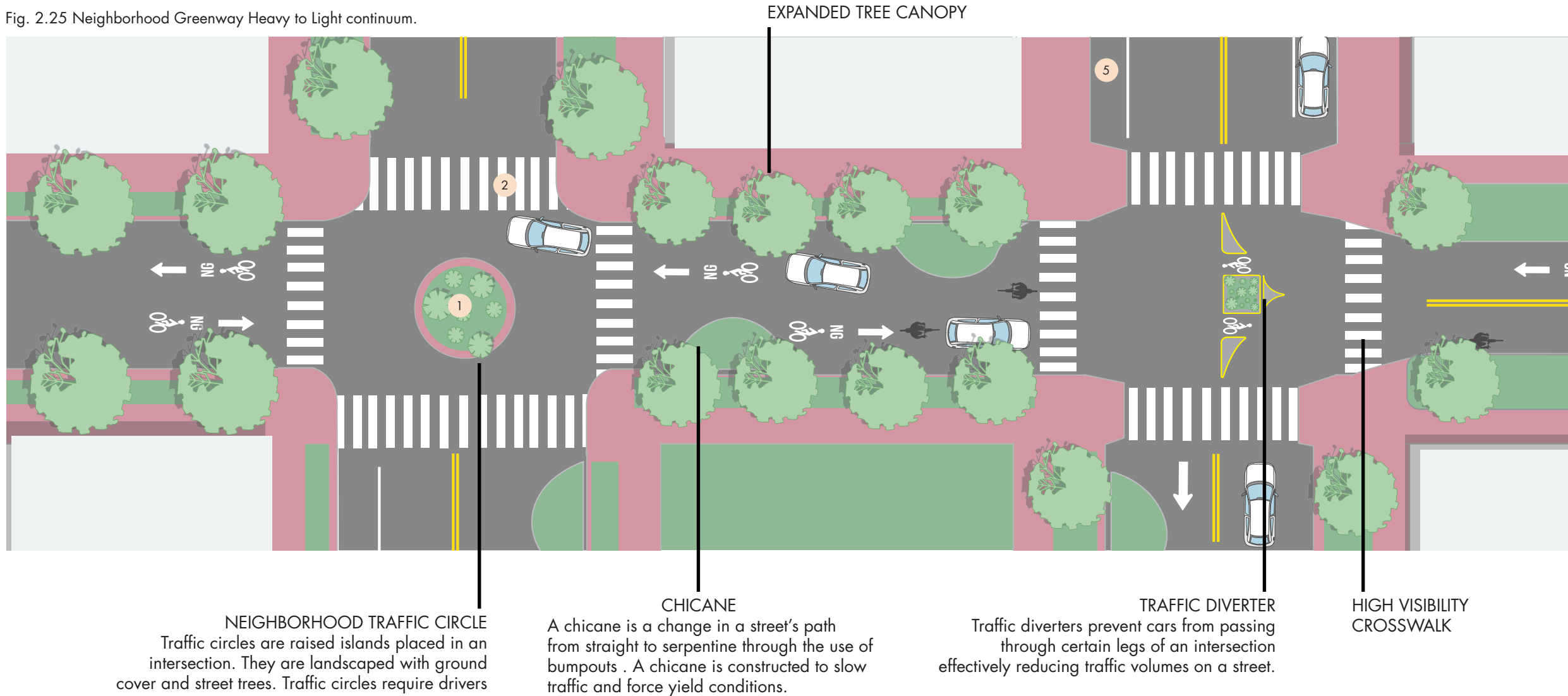

Neighborhood Greenways (NG) are slow speed streets where people can safely and comfortably share the road with a low volume of car traffic. Streets with high daily volumes and speeds (over 10,000VPD or over 30 mph) are not appropriate as Neighborhood Greenway bicycle facilities. Neighborhood Greenway Heavy streets should have less than 600 VPD, with speeds less than 20 mph.

The amount of financial investment and level of traffic diversion to accomplish greenways ranges from Heavy to Light, and can be described as a continuum of traffic design and streetscape improvement strategies that prioritize bicycle travel over automobile to various degrees, while providing streetscape improvements that directly benefit pedestrians and property owners. A Neighborhood Greenway "heavy" (NGH) presents higher traffic diversion and level of investment than a "light". In addition, NGH usually have a higher concentration of greenway design elements.

# BICYCLIST: NEIGHBORHOOD GREENWAY (LIGHT)

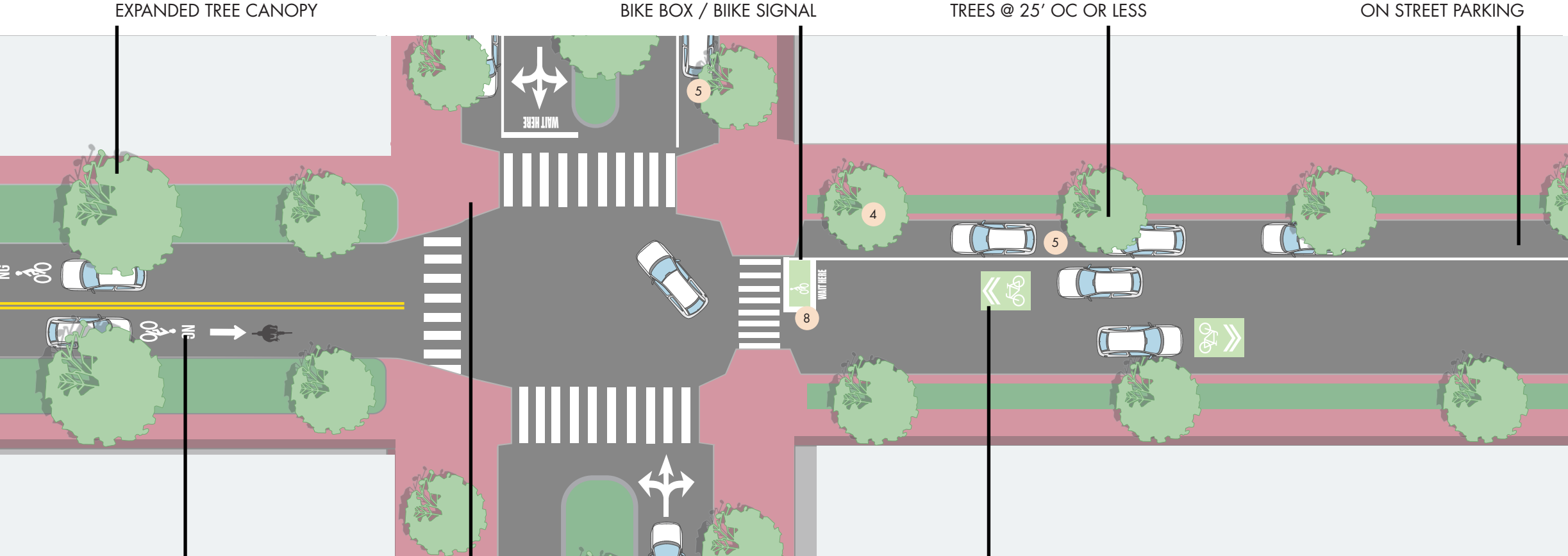

EXPANDED TREE CANOPY

BIKE BOX / BIKE SIGNAL

TREES @ 25' OC OR LESS

ON STREET PARKING

NARROW LANES = SLOW TRAFFIC

**CURB EXTENSIONS**  
 Curb extensions narrow the street at intersections or mid-block by widening the sidewalk. They improve pedestrian safety by reducing the crossing distance and improving sight distance. They may also influence driver behavior by changing the appearance of the street to be more narrow.

**PAVEMENT MARKINGS AND SIGNAGE**  
 Sharrows in a neighborhood greenway should be used if done in concert with other traffic calming methods to make a true neighborhood greenway. Should not be a replacement for protected facilities installed along streets where they cannot be accommodated. The sharrows can be green colored, or have some other distinctive marking.

Streets designated as Neighborhood Greenway Light (NGL), tend to have existing low traffic volumes, and can be easily converted through signage, re-striping, minor construction, or policy change. Neighborhood Greenway Light streets should have less than 300-600 VPD, with speeds less than 20 mph. Streets designated Neighborhood Greenway Light work together with Neighborhood Greenway Heavy in a network of neighborhood streets that have significantly lower traffic volumes and speeds. Areas along the street might require the implementation of traffic circles, bulb outs and diverters in order to accomplish the necessary traffic calming and diversion that characterize these types of neighborhood streets. Other potential treatment is to remove stop signs along the route and only use them for intersecting streets so that people cycling don't have to slow down at minor intersections.

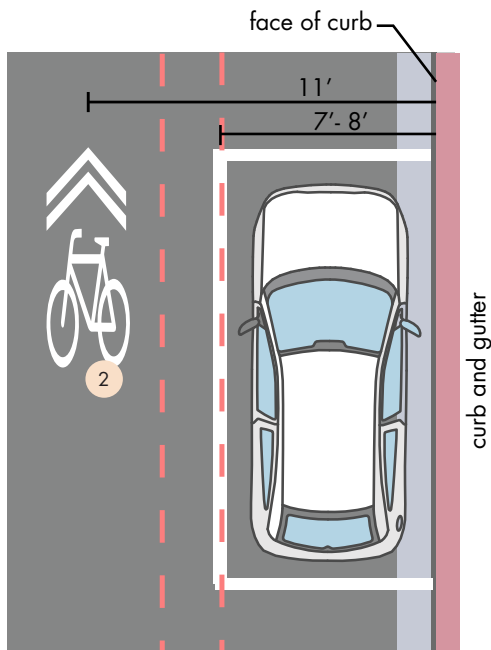

Fig. 2.26 Pavement marking placement with parallel parking.  
 = door zone

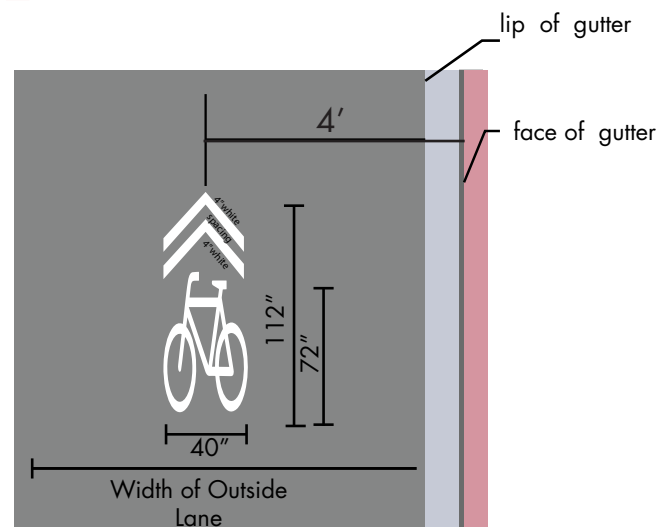

Fig. 2.27 Pavement marking placement on travel lane.

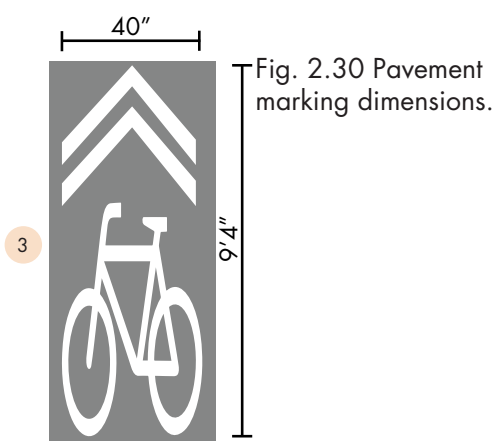

Fig. 2.30 Pavement marking dimensions.

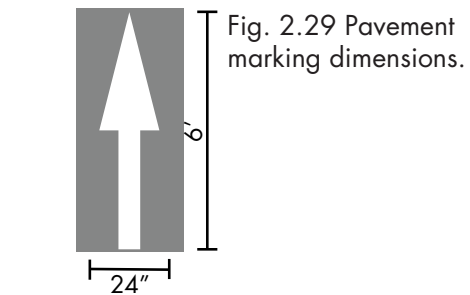

Fig. 2.29 Pavement marking dimensions.

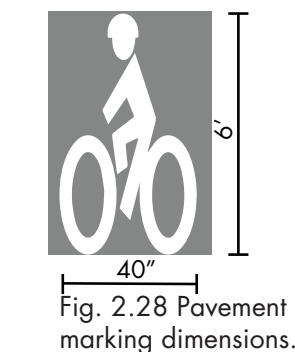

Fig. 2.28 Pavement marking dimensions.

No stripe at edge of curb & gutter or paved shoulders

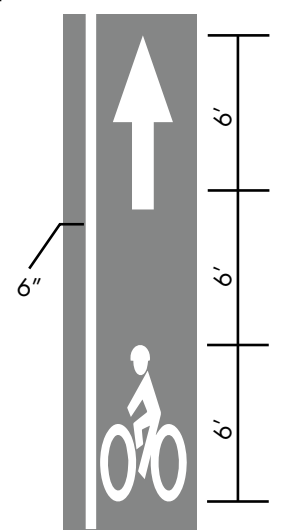

Fig. 2.31 Pavement marking dimensions.

Pavement markings are an integral part of bicycle facility design. The proper placement of pavement markings visually designates where the bicyclist should travel, alert motorists and pedestrians of the presence of bicyclists and establish a route.

- 1 The minimum placement of a sharrow when no parking is present is 4' away from the gutter. On streets with posted 25 MPH or less, sharrows shall be placed in the middle of the lane
- 2 Minimum placement when parallel parking is present: 11' to avoid the door zone conflict. Center lane placement if posted speed is 25 MPH or less.
- 3 Standard marking MUTCD figure 9C-9
- 4 Color may be used as shown.

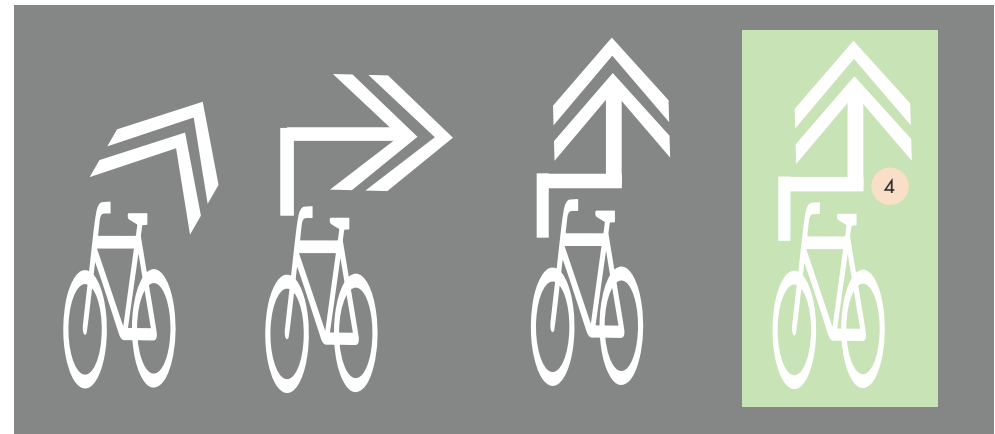
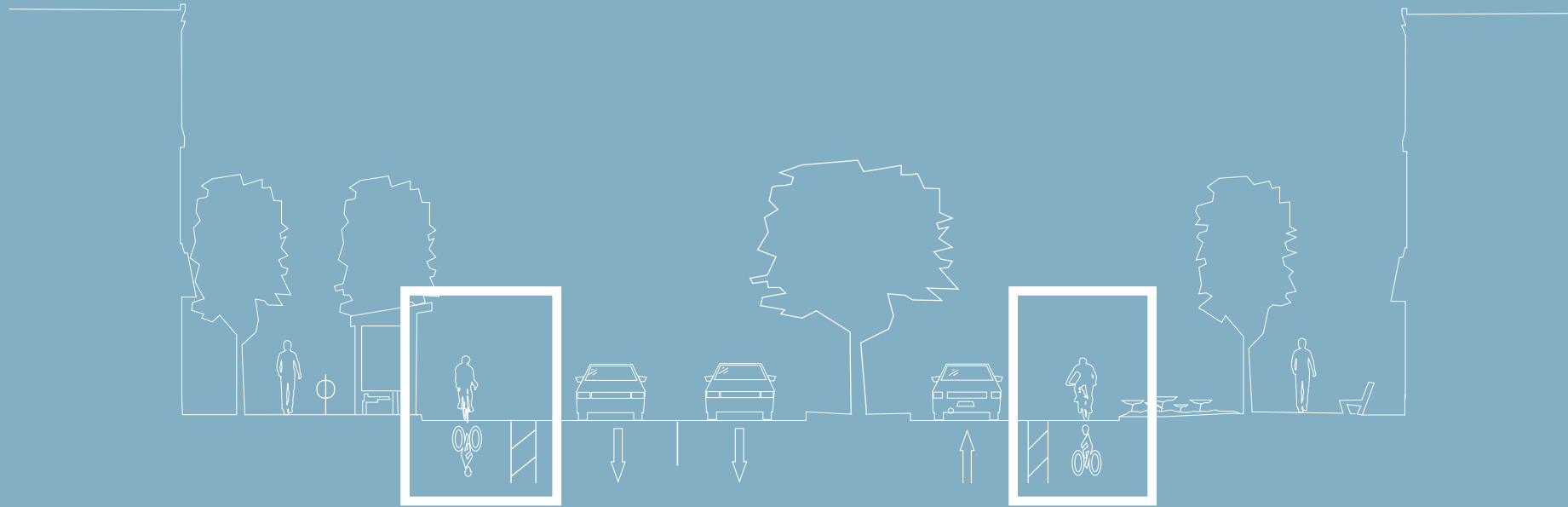

Fig. 2.32 modified shared lane markings for route designation and directionality.



## UNPROTECTED BIKE LANES



These types of facilities are the most commonly found in cities across the US to date. There are several variations on the conventional bike lane that are included in the pages that follow. These are all part of a continuum of bicycle facilities that are unprotected from car traffic. Unlike Neighborhood Greenways, bicycles on unprotected bike lanes do not share the road with car traffic, but they are not physically separate or grade separate, as with projected bike lanes. They are not to be used on roads with more than 25,000 VPD or more than 35 mph.

# BICYCLIST: CONVENTIONAL BIKE LANE

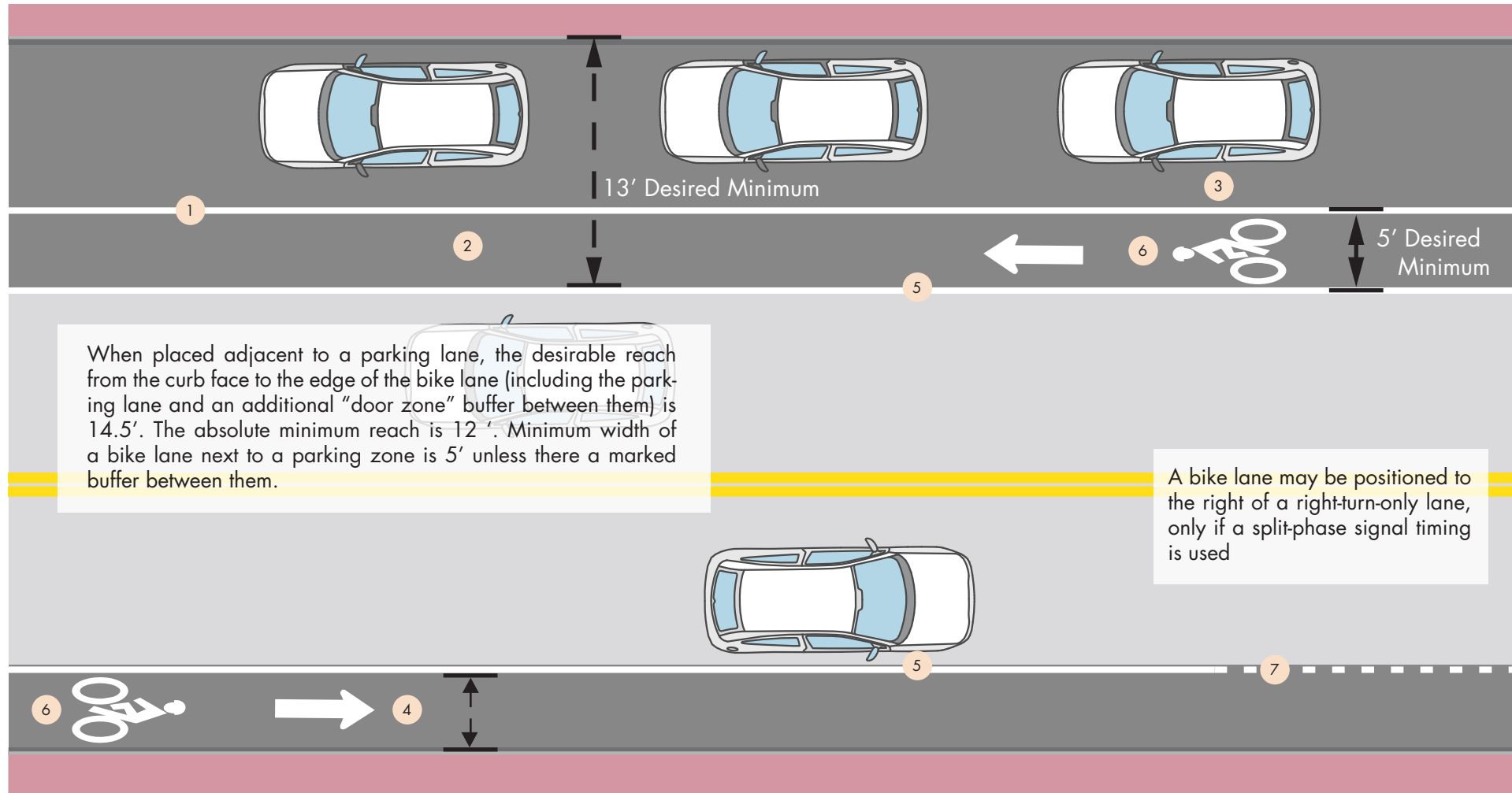

- 5 A solid white line shall be used to separate motor travel lanes from the bicycle lane. A 6-8" line is typically used.
- 6 Bicycle lane word and/ or symbol and arrow markings shall be used to define the bike lane and designate that portion of the street for preferential use by bicyclists. Markings shall be placed outside motor vehicle tread path at intersections, driveways and merging areas in order to minimize wear and tear from the motor vehicle path
- 7 Dashed striping shall be used through high traffic merging areas (intersections, driveways, etc)

Fig.2.33 Conventional bicycle lane.

- 1 When placed adjacent to parking, a solid white line (4"- 6") shall be used between parked cars and the bike lane to minimize encroachment.
- 2 6' is the desired minimum width for a bike lane adjacent to parked cars in order to minimize potential conflicts with pedestrians or motorists.
- 3 Ideally, parking spaces include a "door zone" when designing a non-protected bike lane configuration to ensure comfort for people parking and for the people traveling by bike.
- 4 The desirable bike lane width adjacent to a curb face is 6 feet. The desirable rideable surface adjacent to a street edge or longitudinal joints is 4 feet with a minimum width of 3 feet.



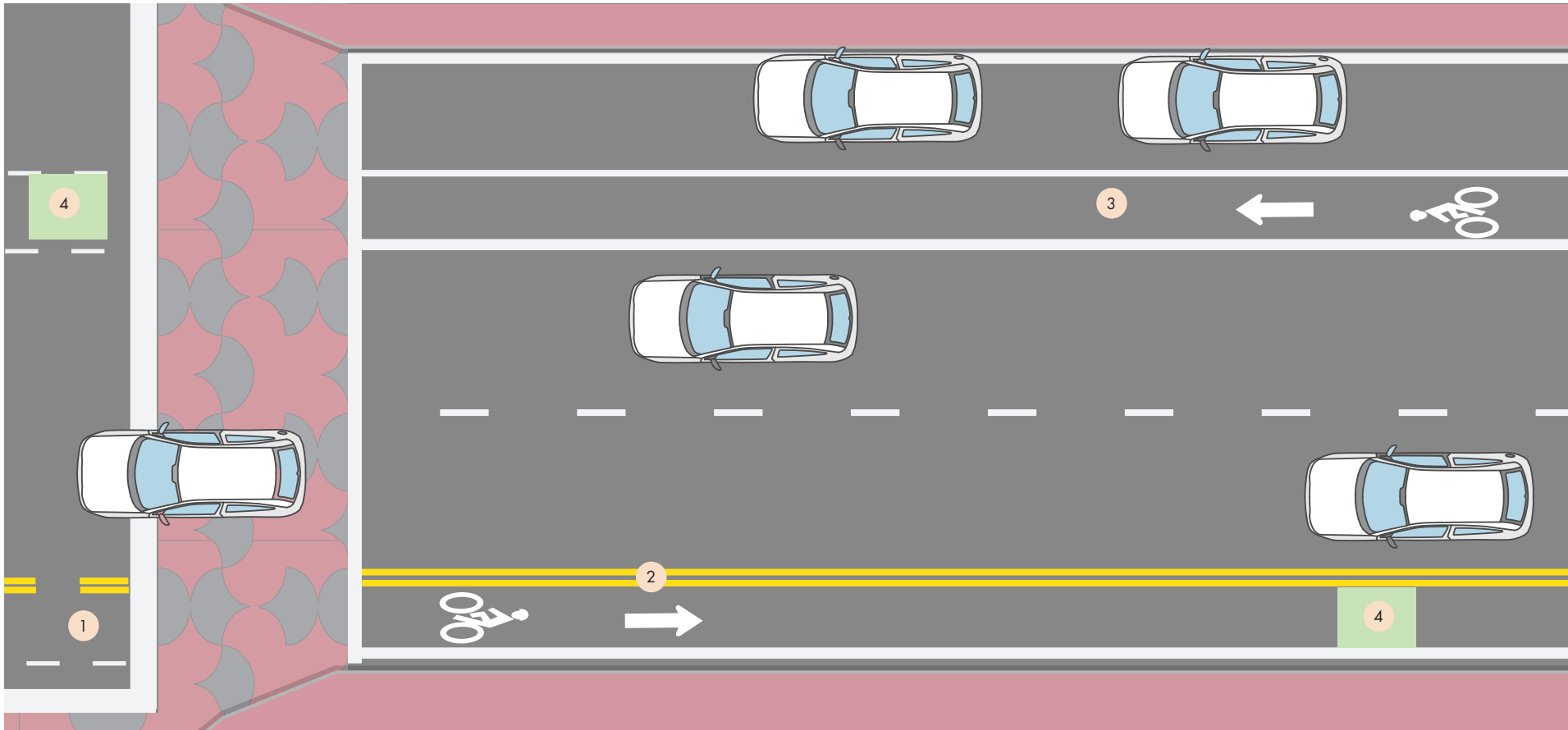

Fig. 2.35 Contraflow bicycle lane.

- 1 Contra-flow bike lane markings should be extended across the intersection, especially for contra-flow bike lanes against the curb, as a way of alerting cross street traffic to look for contra-flow bicyclists.
- 2 When configured without parking, a solid double yellow line marking should be used to separate the contra-flow bike lane from the opposing vehicle travel lane. A curb or median should be used in place of double yellow line. In this case, the facility becomes a contra-flow protected bike lane.
- 3 Where there is room, bike lanes should be used on both sides. When there is no room, for a with-flow lane, shared lane markings should be used to guide with-flow bicyclists to keep to the right side of the road.
- 4 Color may be used along the facility to draw attention to the unique function of the lane, or in areas of cross traffic such as drive ways and intersections.

## BICYCLIST: COMBINED TURN LANE

Protected intersections are preferred over mixing zones. However, mixing zones are ideal in constrain conditions or as interim solutions. Mixing zones are only appropriate where the bike facility is unidirectional.

Mixing zones create a defined area in the roadway where motorists yield to bicyclist and cross paths in order to turn right at an intersection. Slow yield movements increase the safety of all users. The following design guidelines should be applied when designing mixing zones:

- Locate the merge point as close as practical to the intersection.
- Keep the merging area as short as possible. From 50' minimum to 100' maximum.
- Provide a buffer and physical separation from the adjacent through lane after the merge area, if possible.
- Highlight the merge/conflict area with green paint, and dashed bike lane markings or shared lane markings (sharrows)
- Install "Begin Right (or Left) Turn Lane Yield To Bikes" sign (R404) at the beginning of the merge area.
- Eliminate parking in the merging area.
- Minimize the length of the storage portion of the turn lane.
- Where posted speeds are 35 mph or higher, or where it is absolutely necessary to provide storage for queued vehicles, a deceleration/storage lane may be necessary in advance of the merging point.

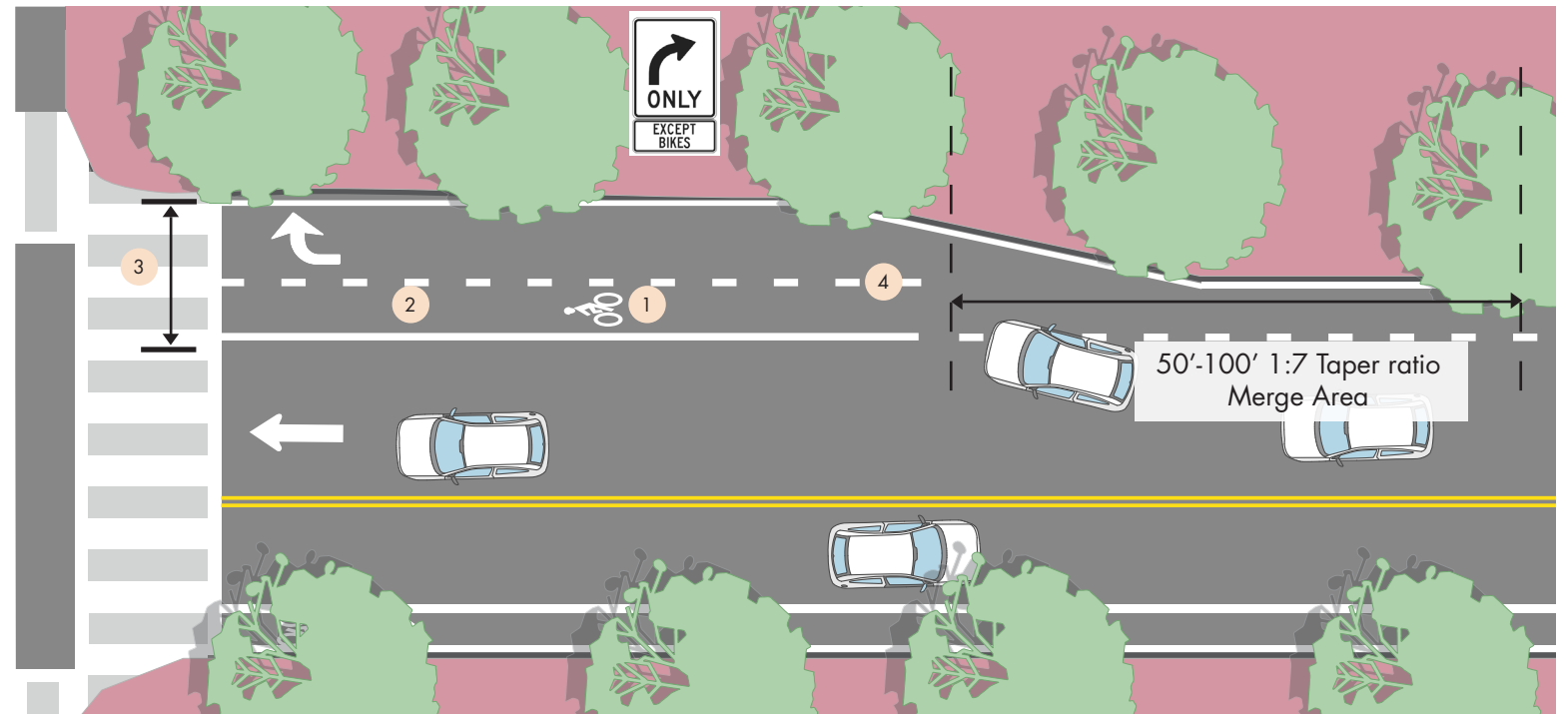
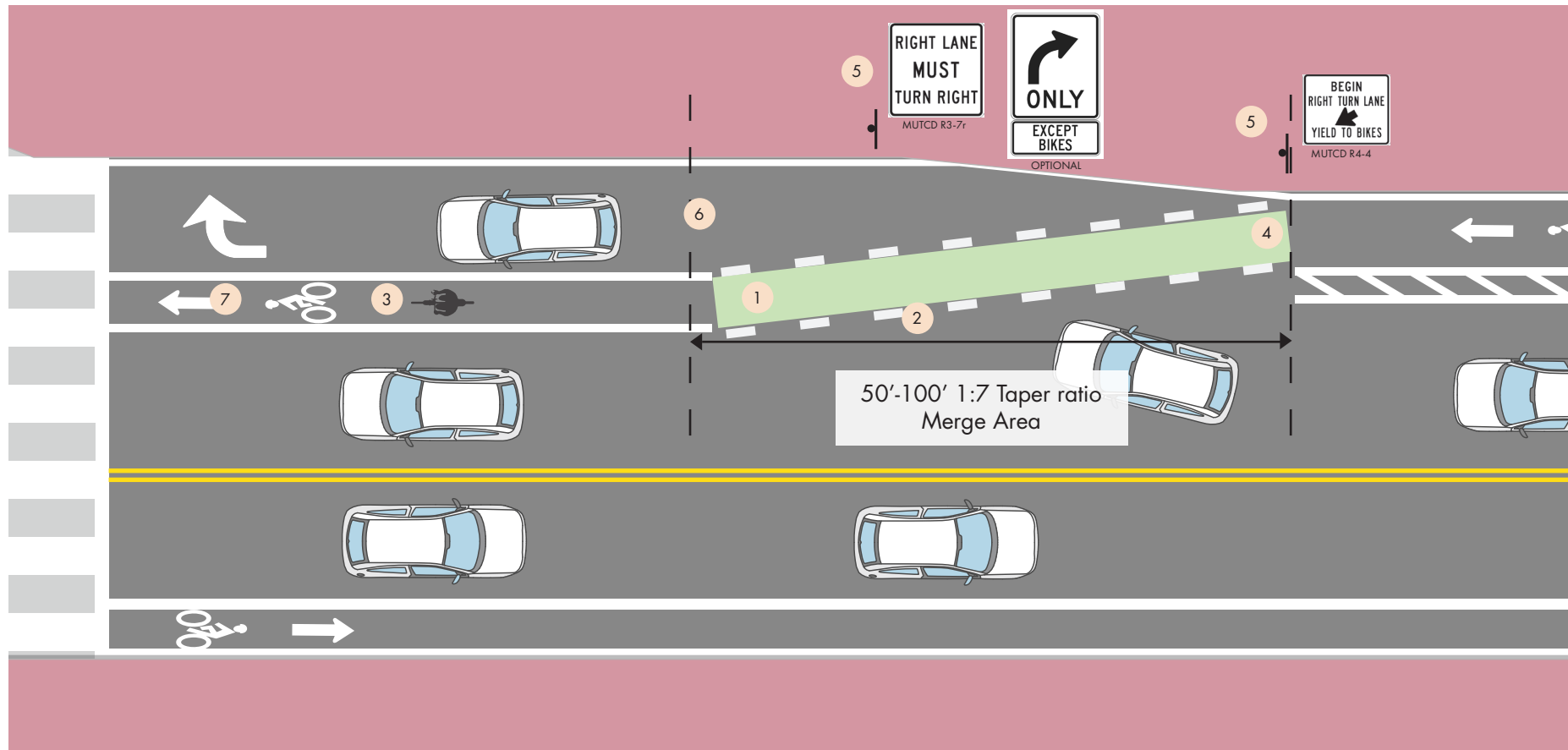

Fig.2.36 Combined turn lane at intersection approach.

- 1 A bicycle marking shall be used to clarify bicyclists position within the combined turn lane.
- 2 The width of the bike travel within the combined turn lane path shall be 4' minimum.
- 3 Width of combined turn lane shall be 9' minimum and 13' maximum. A full bicycle through lane can be accommodated if the vehicle right turn only lane can be made 14' or wider.
- 4 A dashed 4" line and bicycle lane marking shall be used for bicyclist position with the combined lane without excluding cars from the suggested bicycle area. Color may be used to highlight conflict area.



- 5 Accompanying signage should include "Right Lane Must Turn Right" MUTCD R3-7r and "Begin Turn Yield To Bikes" MUTCD R4-4.
- 6 Through bike lanes should be provided at any intersection approach where a Right Turn Only Add Lane lane is created. It is desirable for bicyclists to travel straight to the merging area to reinforce right of way.
- 7 Bicycle signal detection should be provided within through lane.

Fig.2.37 Through bicycle lane intersection approach.

- 1 The desirable width of a through lane and dashed bike transition is 6' with a minimum of 4'. Dashed white lines should be 6" wide and 2' long with a 2' to 6' gap between dashes. If lanes are not painted in full, transitions should be painted to emphasize path and conflict zones.
- 2 The through lane shall be placed to the left of the Right Turn Only lane.
- 3 Bicycle lane word and/ or symbol and arrow markings shall be used to define the bike lane and designate that portion of the street for preferential use by bicyclists. Markings shall be placed outside motor vehicle tread path at intersections, driveways and merging areas in order to minimize wear and tear from the motor vehicle path.
- 4 Dashed lines signifying the merge area shall begin a minimum of 50' before the intersection. Dotted lines should begin 100' before the intersection if along a high speed/ volume roadway.

## BICYCLIST: THROUGH BIKE LANE (SHARROWS)

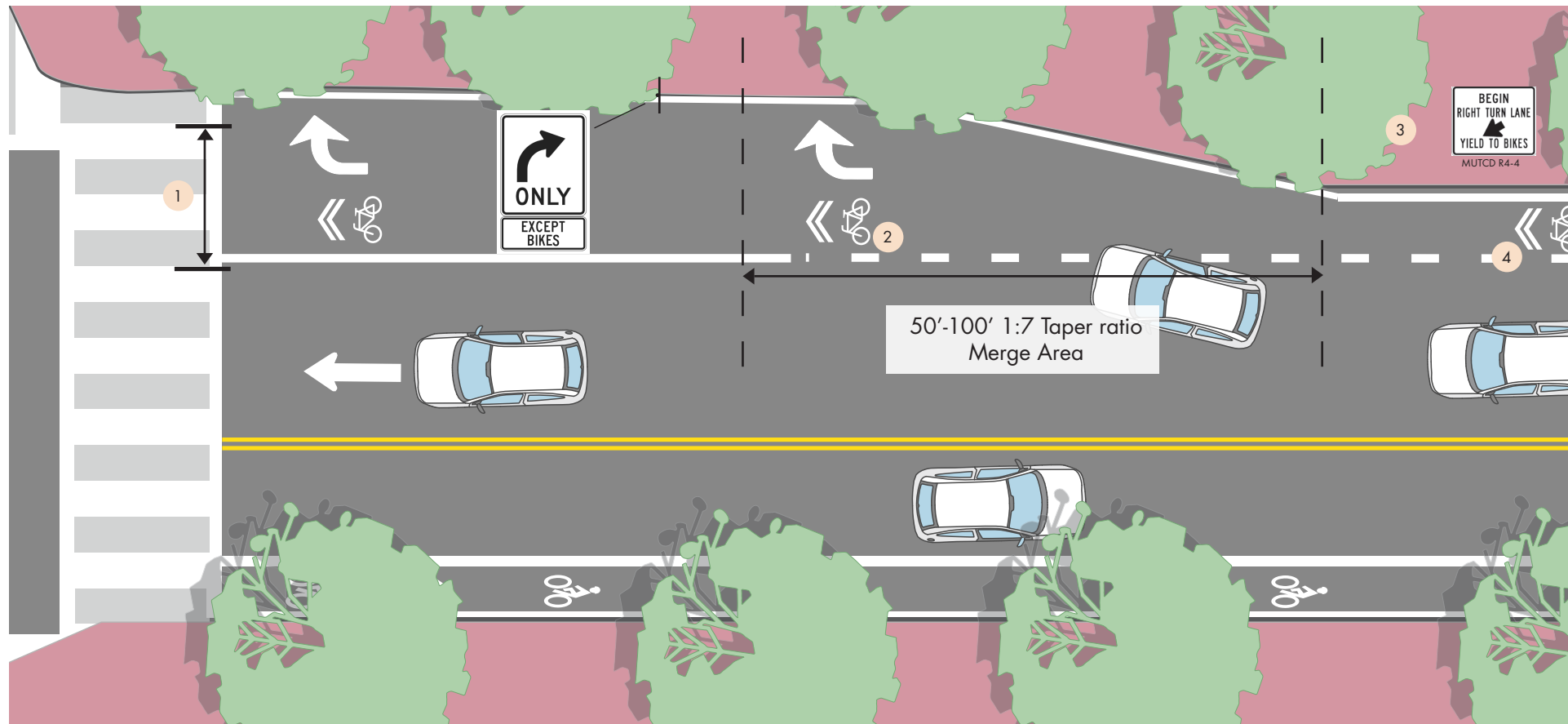

Fig.2.38 Through bicycle lane with sharrows at intersection approach.

- 1 Width of combined turn lane shall be 9' minimum and 13' maximum. A full bicycle through lane can be accommodated if the vehicle right turn only lane can be made 14' or wider.
- 2 Bicycle symbol indicating a shared lane marking shall be used to designate that portion of the street for preferential use by bicyclists and encourage safety.
- 3 Accompanying signage should include "Right Lane Must Turn Right" MUTCD R3-7r, and "Begin Turn Yield To Bikes" MUTCD R4-4.
- 4 Dashed lines signifying the merge area shall begin a minimum of 50' before the intersection. Dashed lines should begin 100' before the intersection if along a high speed/ volume roadway.

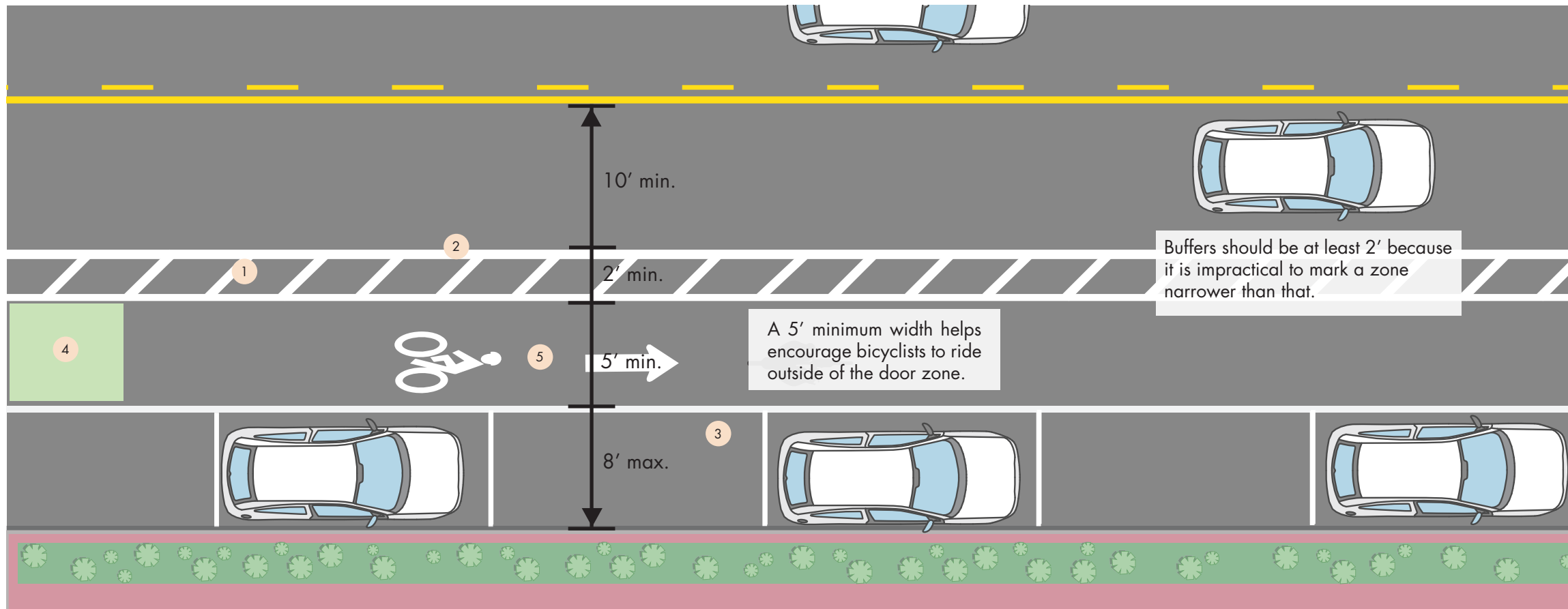

Fig. 2.39 Buffered bicycle lane.

- 1 The buffer shall be marked with two solid white lines with diagonal hatching if 3' of width or wider. Double white lines indicate where crossing is discouraged though not prohibited.
- 2 Like a conventional bike lane, a wide 6" - 8" solid white line is used to mark the edge adjacent to a motor travel lane
- 3 A Solid line or parking T's are acceptable markings to separate parking zone from the bicycle lane.
- 4 Color may be used at the beginning of each block and throughout entire bikeway to encourage motorists to stay in motor travel lanes and avoid conflict with people traveling by bicycle.
- 5 Bicycle lane word and/ or symbol and arrow markings shall be used to define the bike lane and designate that portion of the street for preferential use by bicyclists. Markings shall be placed outside motor vehicle tread path at intersections, driveways and merging areas in order to minimize wear and tear from the motor vehicle path

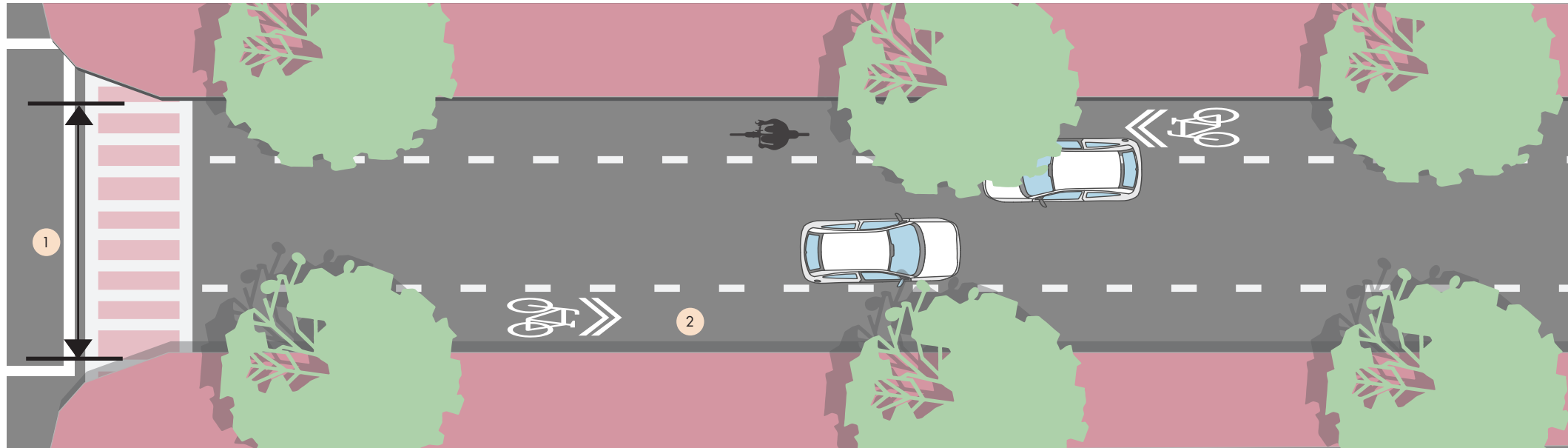

Fig. 2.40 Advisory bike lane with shared lane markings.

- 1 Advisory bike lanes are used on streets that are too narrow for conventional on street treatment/ bicycle facility.
- 2 Advisory bike lanes look like dedicated bike lanes except that a dashed line is used instead of a solid line. This allows drivers to drive on the bicycle space when a bicyclist isn't present

### DRIVER

- This facility brings awareness to the travel way as a shared space when a bicyclist is not present. It helps to reduce travel speeds while not narrowing the travel lanes.
- It is OK to drive over the dashed line when bicyclists are not present.
- If a bicyclist is traveling in the advisory bike lane, move to the center completely to pass.
- If there is oncoming traffic and a bicyclist present, stay behind the bicyclist until its safe to pass.
- When passing, the vehicle must leave at least 3 feet between the vehicle and the bicyclist.

### BICYCLIST

- Watch for merging motorists
- Use caution, look back when turning left and signal your intentions.
- Always assume that motorists may not see you.



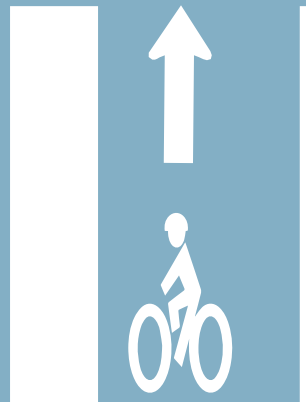

## PROTECTED & SEGREGATED BIKE FACILITIES

These types of facilities are implemented on streets with medium to high vehicle traffic (<20,000 ADT), and speeds of 35 mph and above. Segregated bike facilities can range from shared-use paths along parks and golf courses to parking protected bicycle lanes.

Segregated or protected bicycle facilities have the highest potential to get more people on bikes whether for fun or for work. By installing physical separation between the bicyclists and other users, the perceived level of safety as well as the actual level of safety increase, making bicycling a viable alternative to a wide range of people.

# BICYCLIST: ON STREET TWO-WAY PROTECTED BIKE LANE

## BASIC BOLLARDS

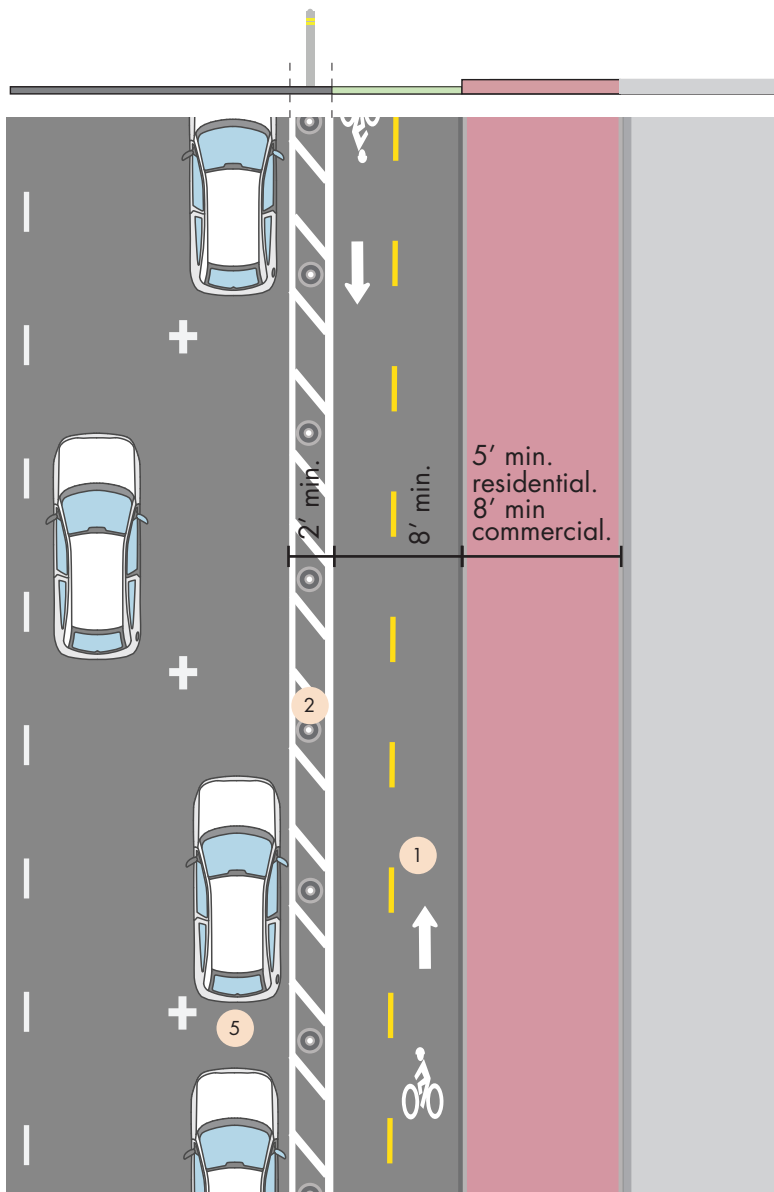

## PLANTERS

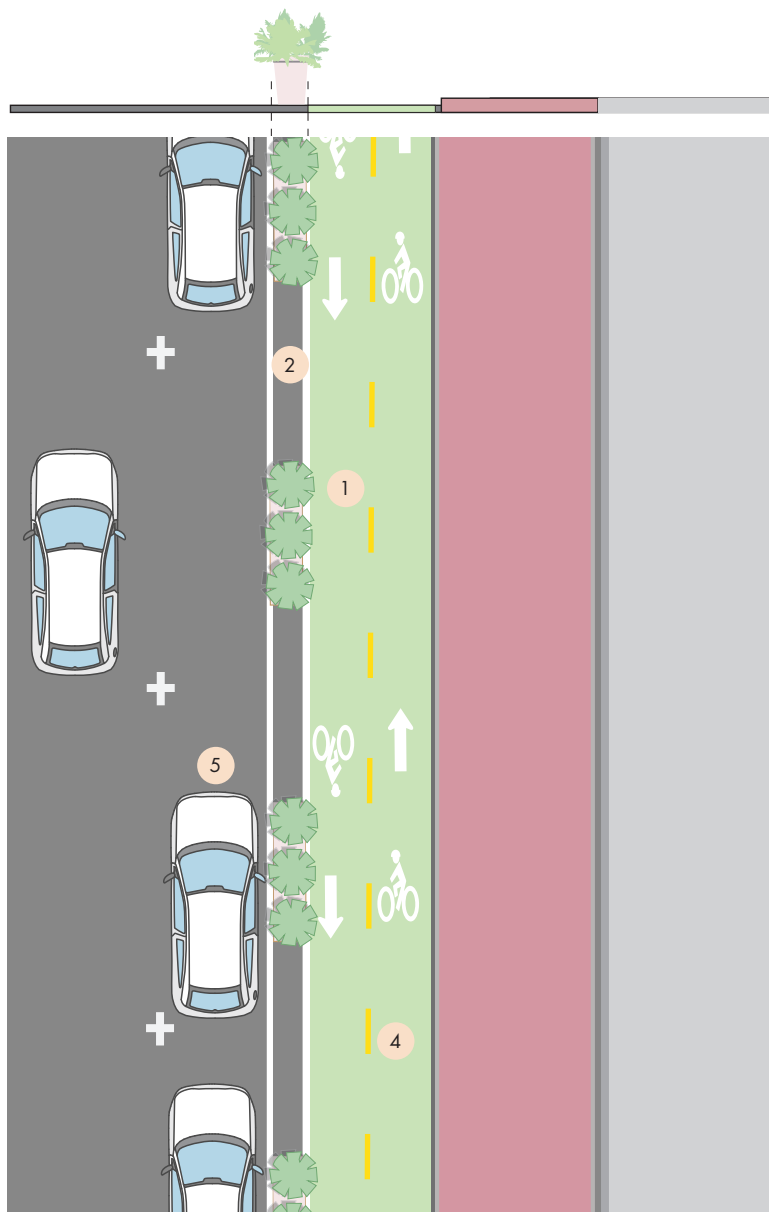

## PARKED CARS

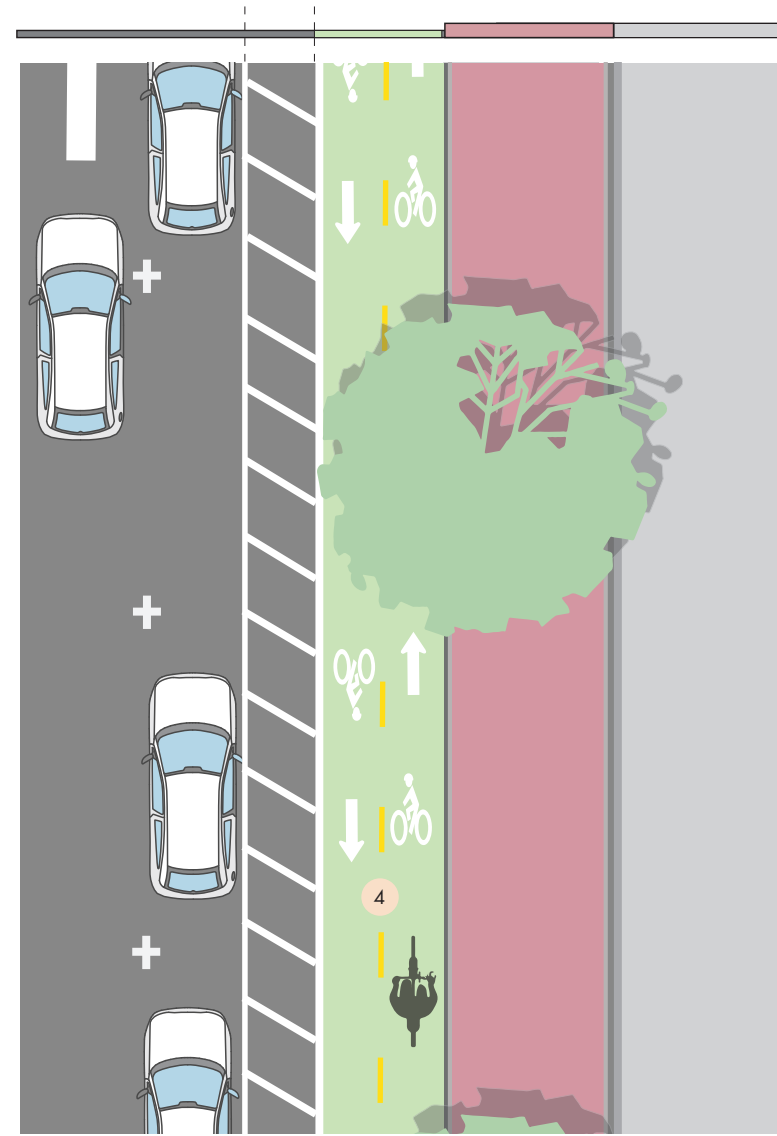
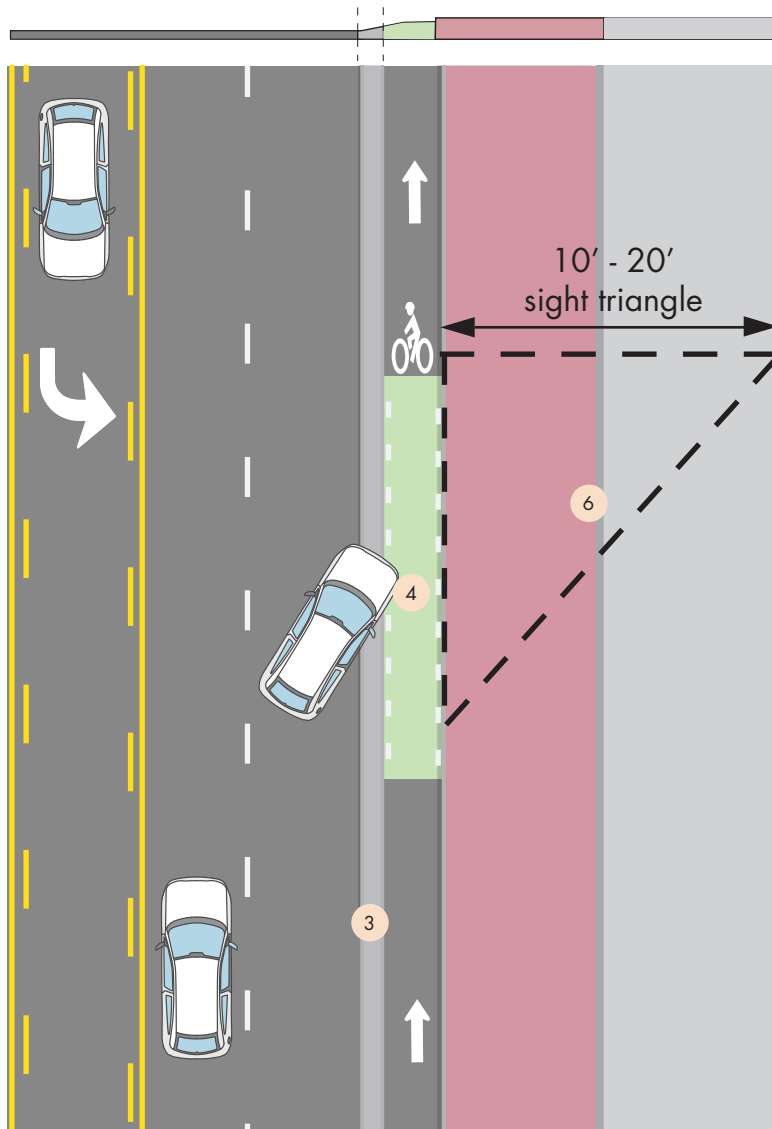

Fig.2.41 Protected bicycle lane with bollards.

Fig.2.42 Protected bicycle lane with planters.

Fig.2.43 Protected bicycle lane with parked vehicles and buffer.

**MOUNTABLE CURB**



**MODULAR CURB**

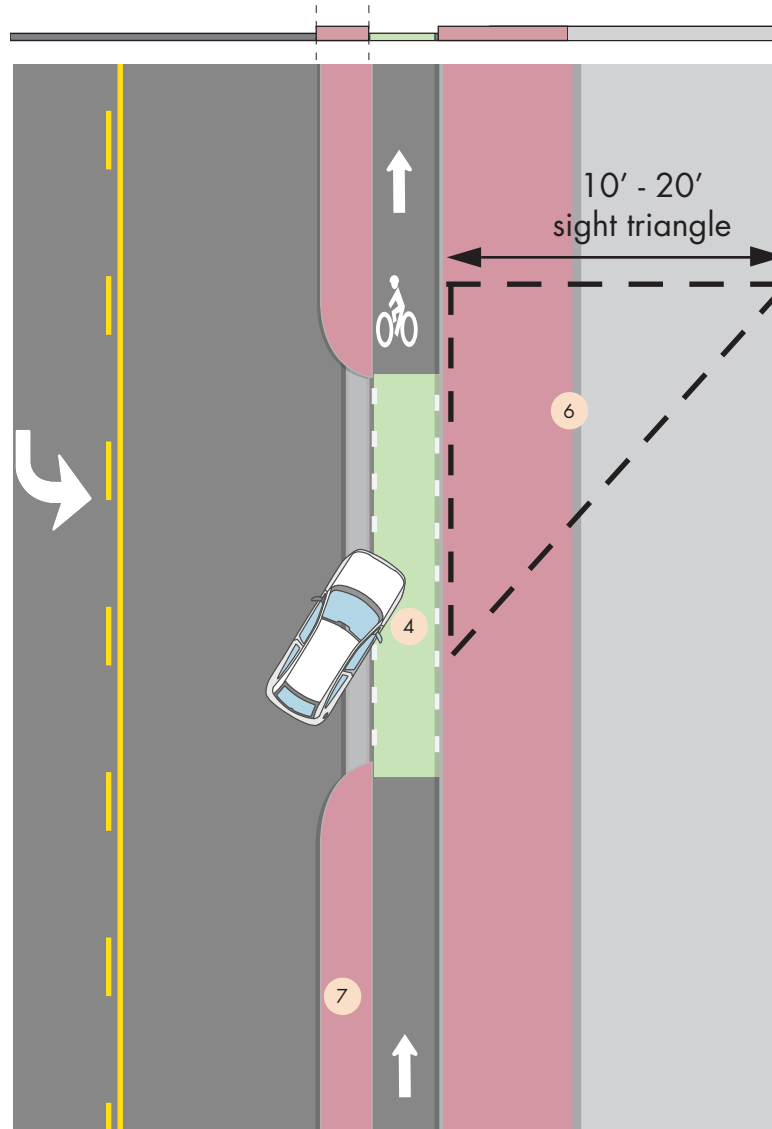

**BIKE PARKING**

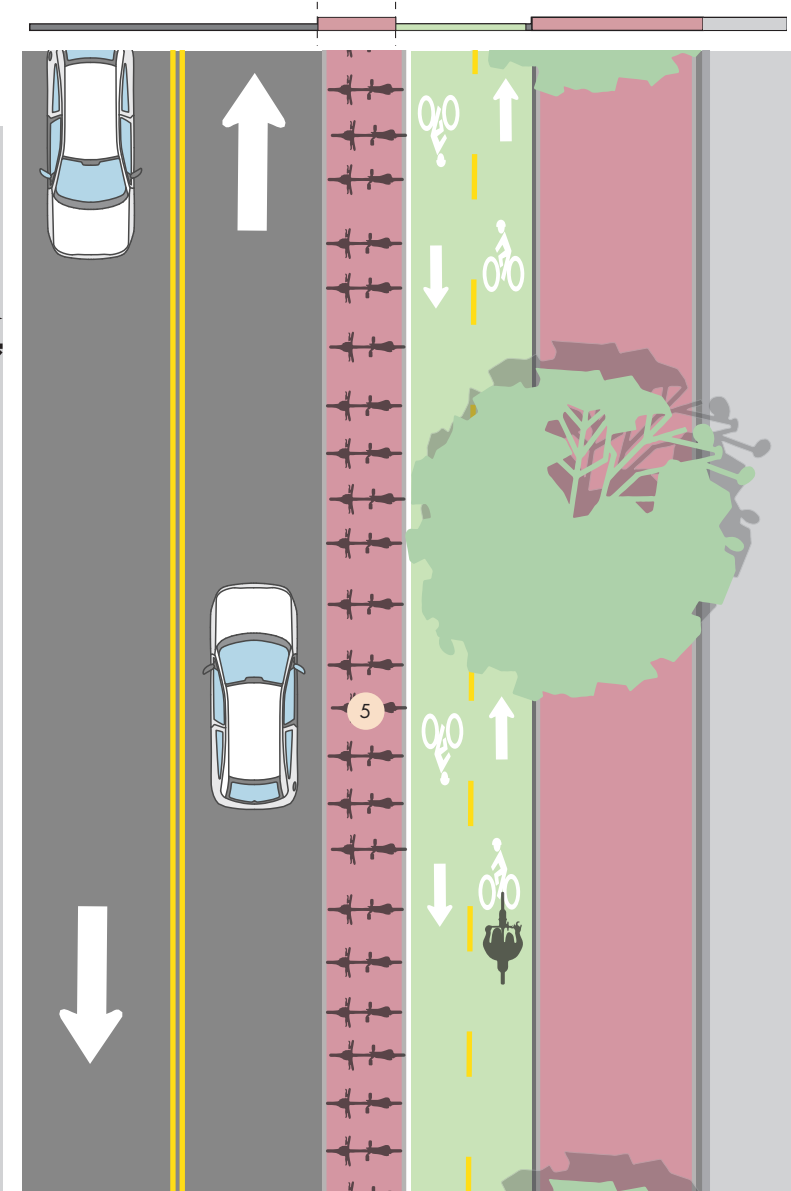

Fig.2.44 Protected bicycle lane with mountable curb.

Fig.2.45 Protected bicycle lane with modular curb.

Fig.2.46 Protected bicycle lane with buffer and bicycle parking.

## BICYCLIST: SIDE WALK LEVEL PROTECTED BIKE LANE

Fig.2.47 Sidewalk-level Protected bicycle lane with landscape buffer.

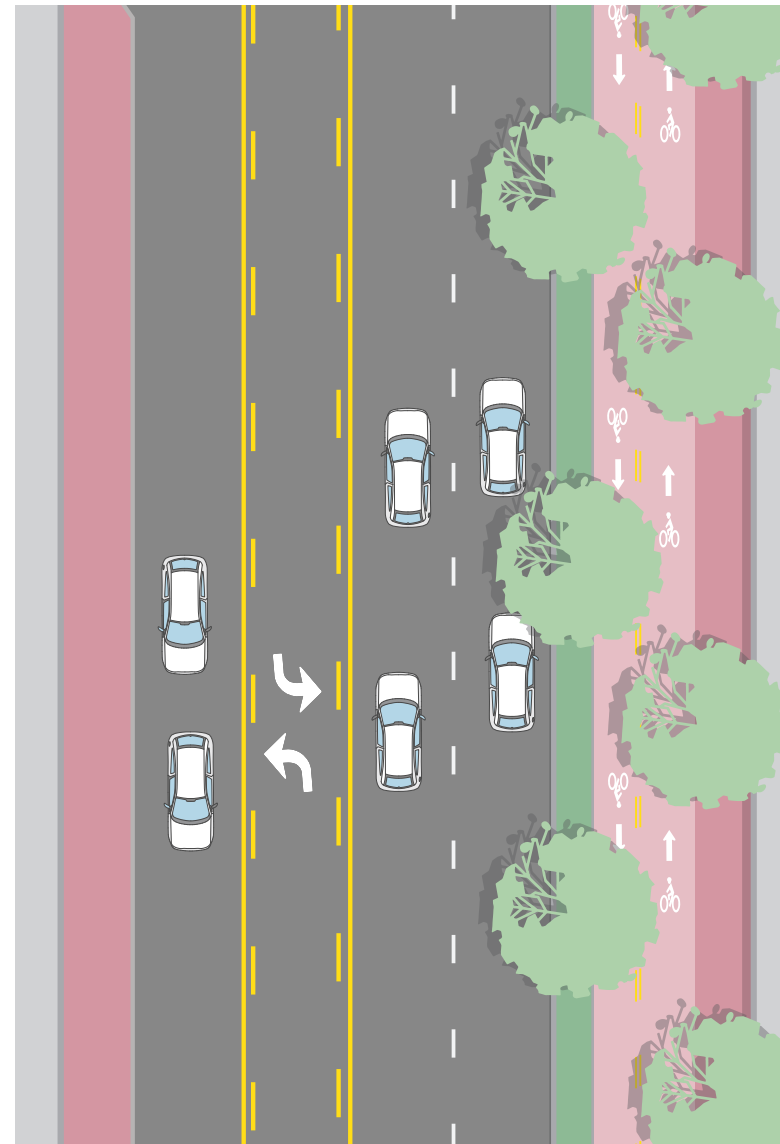

LANDSCAPE BUFFER

Fig.2.48 Sidewalk-level Protected bicycle lane with mountable curb (no parallel parking).

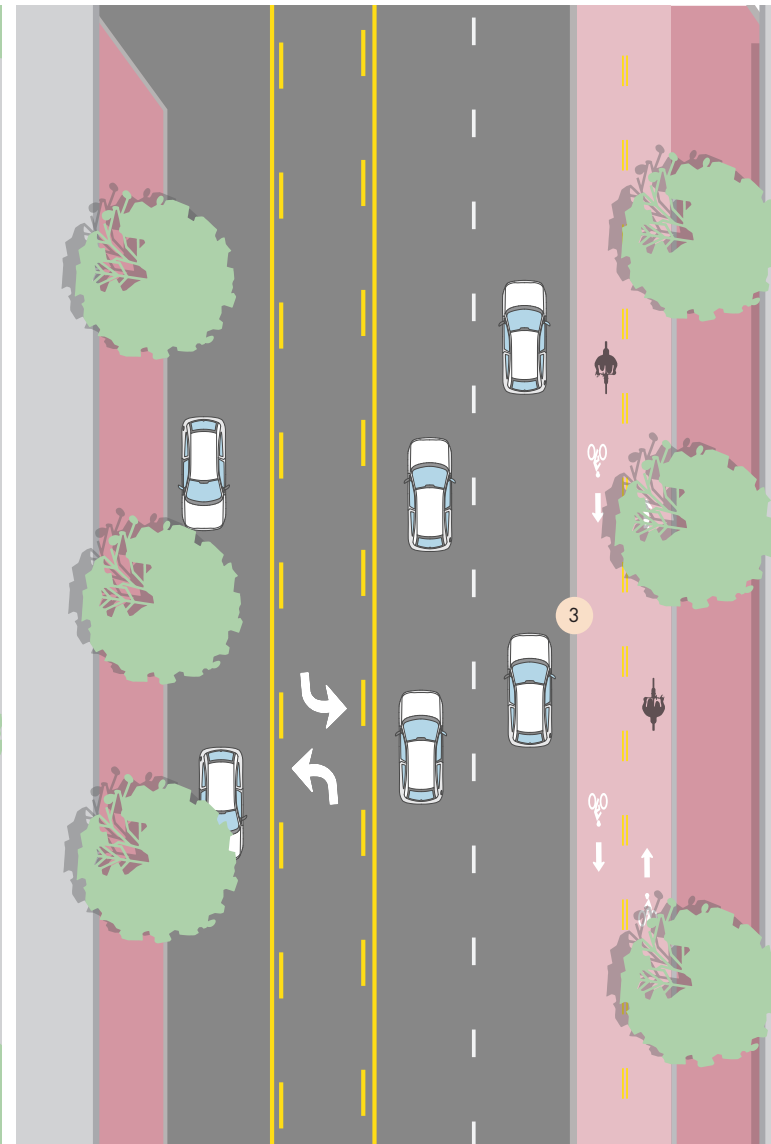

MOUNTABLE CURB

Fig.2.49 Sidewalk-level Protected bicycle lane with parked vehicles, mountable curb and buffer.

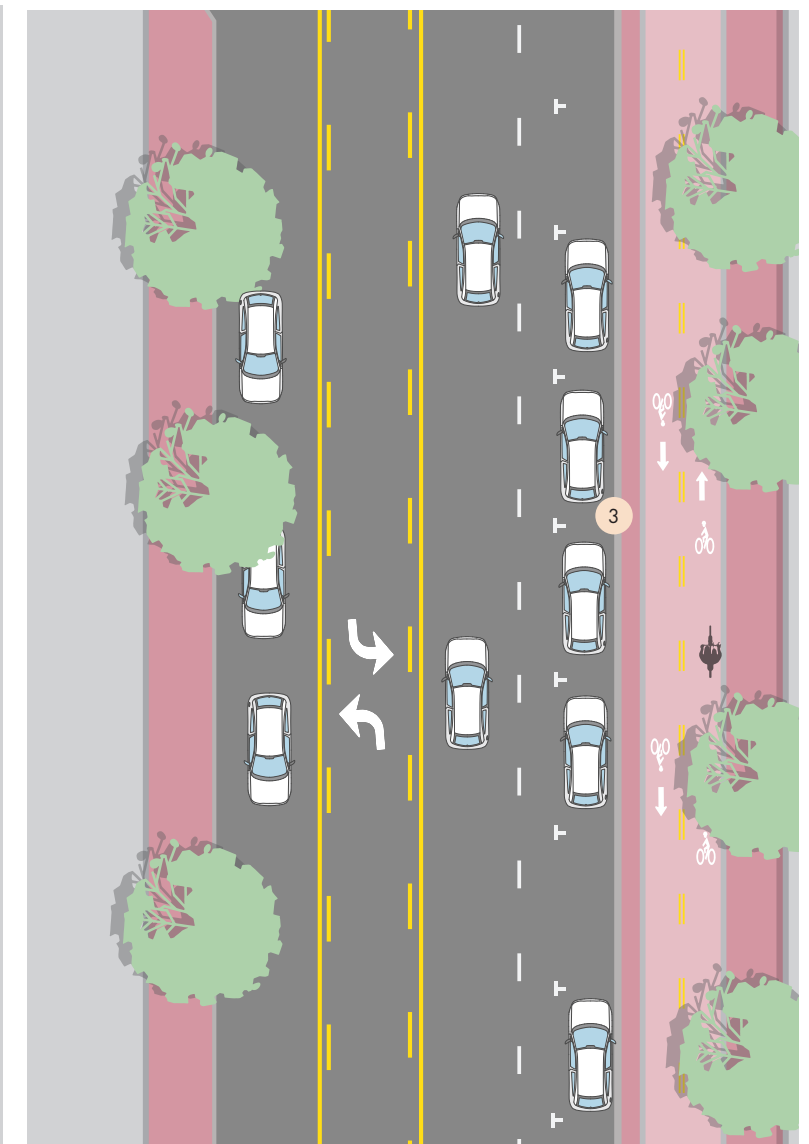

PARKED CARS &amp; MOUNTABLE CURB

Fig.2.50 Sidewalk-level Protected bicycle lane with mountable curb and parallel parking.

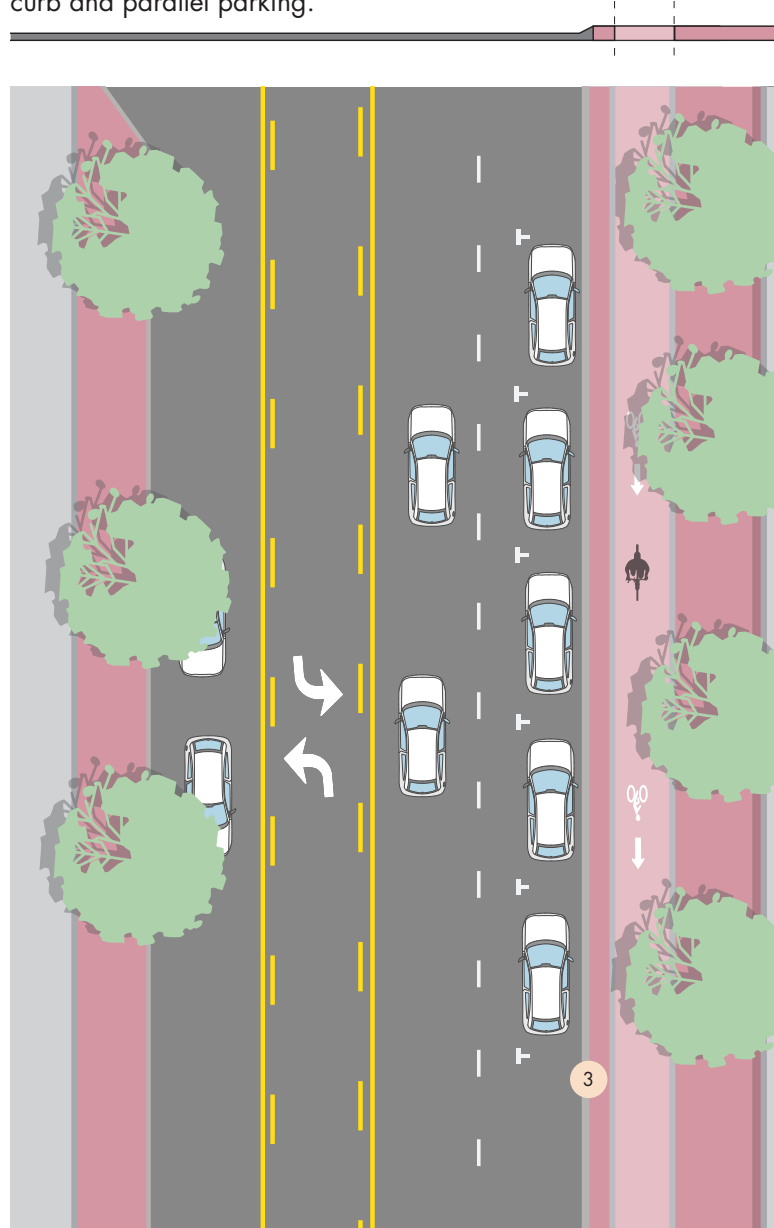

ONE WAY & MOUNTABLE CURB

Fig.2.51 Sidewalk-level Shared use path.

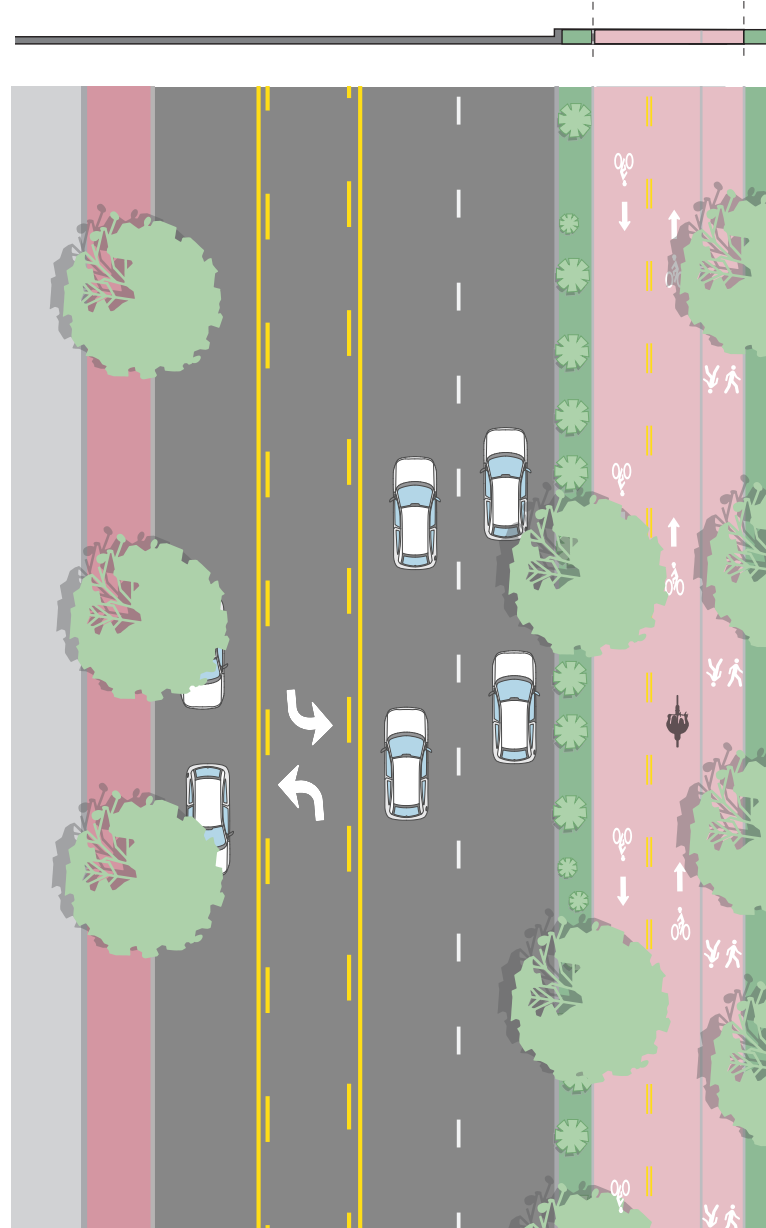

SHARED PATH

Fig.2.52 Sidewalk-level Protected bicycle lane driveway condition.

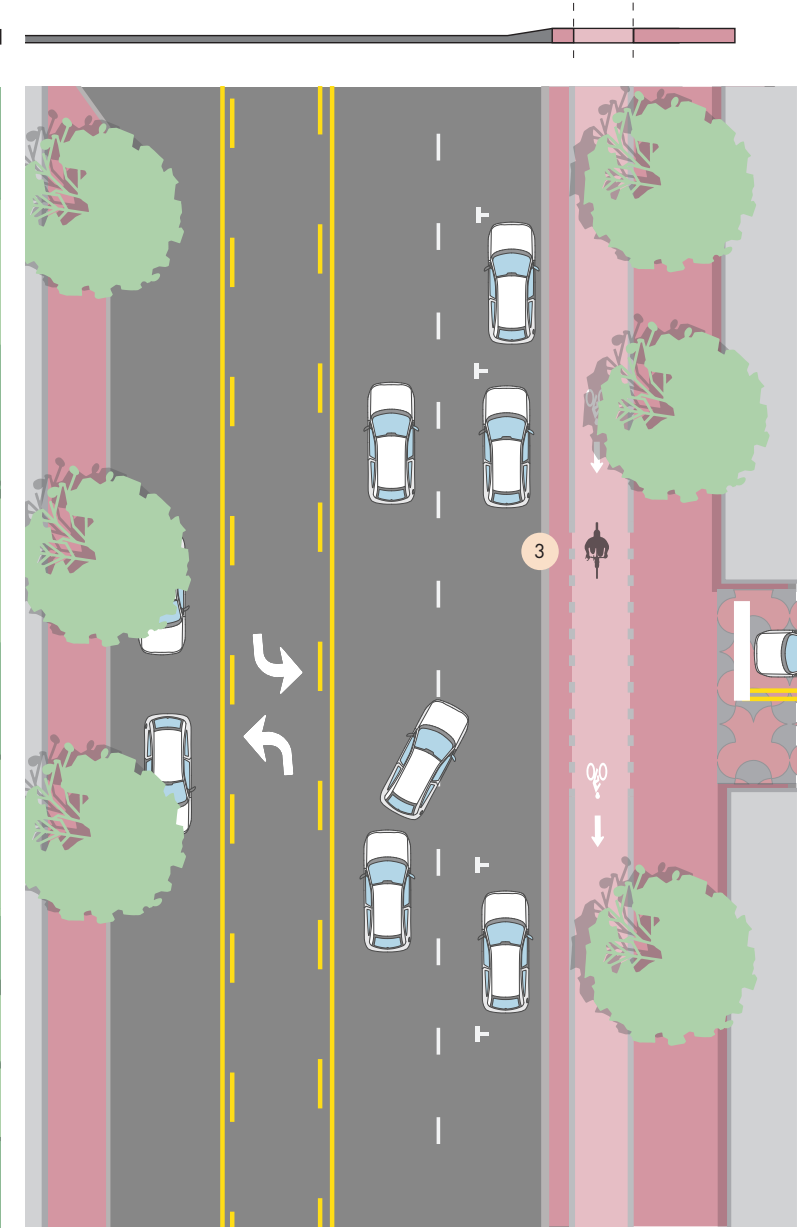

DRIVE WAY CONDITION

# BICYCLIST: PROTECTED BIKE LANE

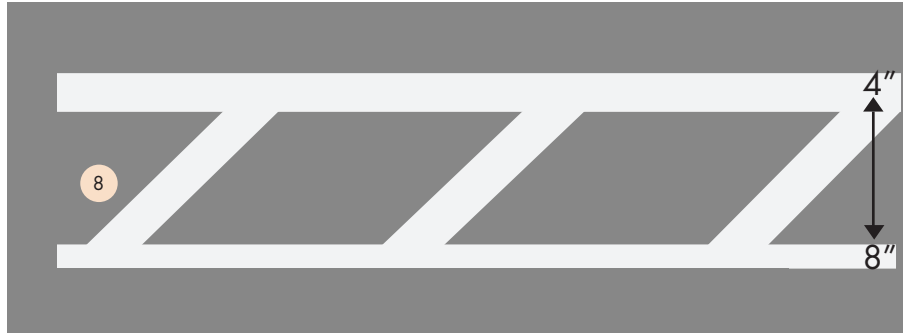

Fig 2.53 Typical dimension of buffer stripes. Width varies. Desired Minimum 3 feet.

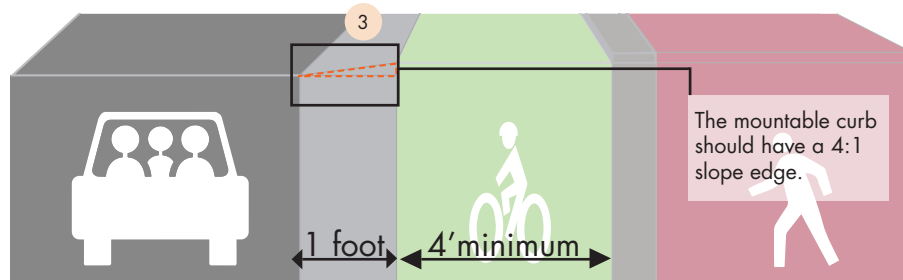

Fig 2.54 Mountable curb detail.

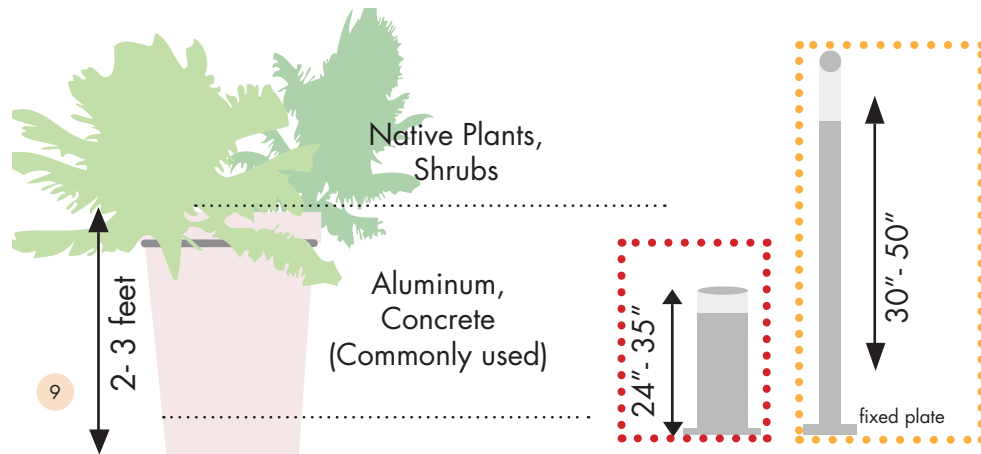

Fig 2.55 Planter detail  
(Design, material and size may vary.)

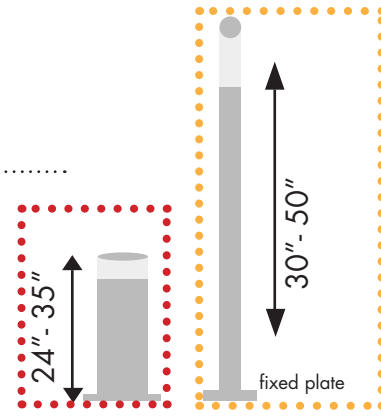

Fig 2.56 Bollard detail.  
(Design, material and size may vary.)

- 1 Bicycle lane word and/ or symbol and arrow markings shall be used to define the bike lane and designate that portion of the street for preferential use by bicyclists. Markings shall be placed outside motor vehicle tread path at intersections, driveways and merging areas in order to minimize wear and tear from the motor
- 2 When protected by a parking lane, 3' is desired for unloading and to prevent dooring collisions.
- 3 When configured next to travel lanes, a mountable curb should be provided to allow bicyclists to pass other bicyclists.
- 4 Color may be used along the facility to draw attention to the unique function of the lane, or in areas of cross traffic such as driveways and intersections.
- 5 On-street parking of cars, motorcycles and bicycles should be used as a traffic calming method as added protection when possible.
- 6 For motor vehicles attempting to cross the protected bike lane facility from the side street or driveway, street and sidewalk furnishings and/or other features should accommodate a sight triangle of 20' to the protected bike lane from minor street crossings, and 10' from driveway crossing.

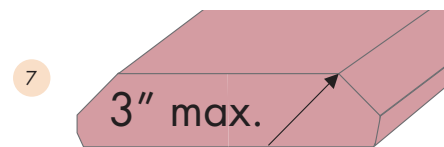
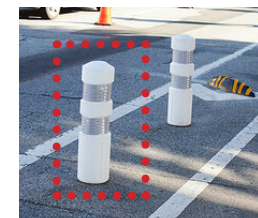

Fig 2.57 Modular curb detail.





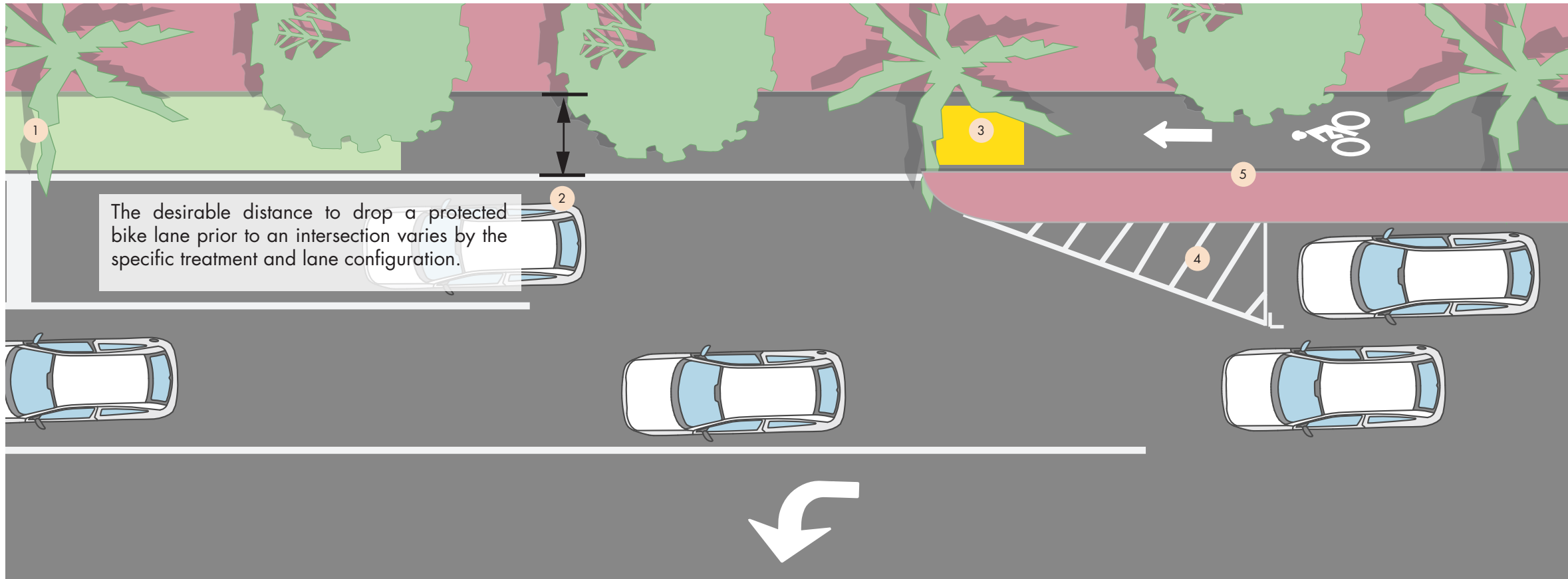

Fig 2.58 Protected bike lane intersection approach.

- 1 When the protected bike lane is dropped on an intersection approach, the intersection shall provide some type of bicycle facility to receive the protected bike lane users. This may be a conventional bike lane, bike box or combined bike lane/turn lane.
- 2 For a transition to a bike lane, the minimum desirable width is 6' with an absolute minimum of 4'. At constrained intersections with right turn lanes, consider transitioning to a mixing zone. (See pages 54-56)
- 3 Tactile warnings or pavement markings should be used on slopes from raised protected bike lanes to slow bicyclists speed prior to the transition out of the protected bike lane, and to warn users of potential conflicts with motor vehicles.
- 4 Parking should be prohibited 30' - 50' in advance of where the protected bike lane buffer ends to promote visibility between people riding bicycles and traveling by car.
- 5 Bicycle-friendly curbs use short (3") angled curbs, to maximize operating space. Full height vertical 6" curbs are not bicycle friendly. Riders risk hitting their pedals on them, and must shy away, reducing the useful space in the protected bike lane.

# BICYCLIST: ADA ACCESSIBLE PROTECTED BIKE LANE INTERSECTION APPROACH

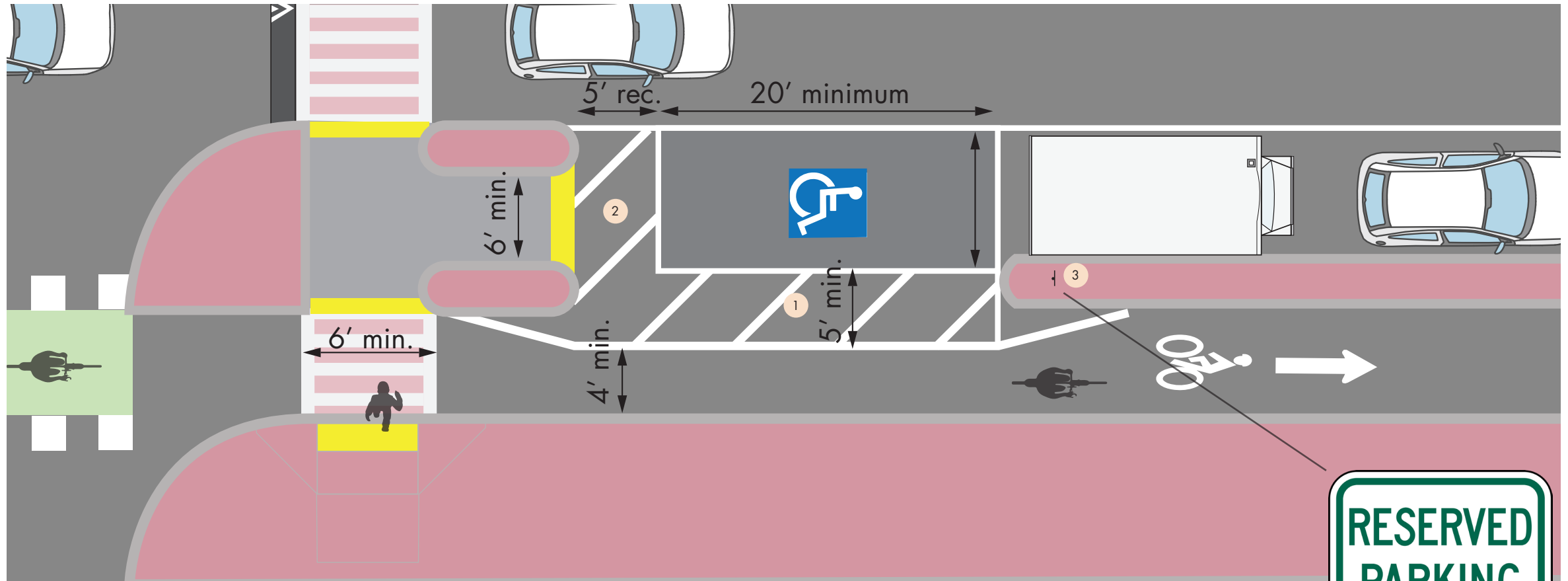

Fig 2.59 ADA Accessible protected bike lane intersection approach.

- 1 Access aisle must match the length of parking space. a 5ft minimum width is required where sidewalk width exceeds 14ft.
- 2 Rear access aisle may be adjacent to pedestrian crossing island in constrained situations.

- 3 Accompanying signage should be placed at the head of each parking space. MUTCD R7-8, and if applicable MUTCD R7-8P



MUTCD R7-8

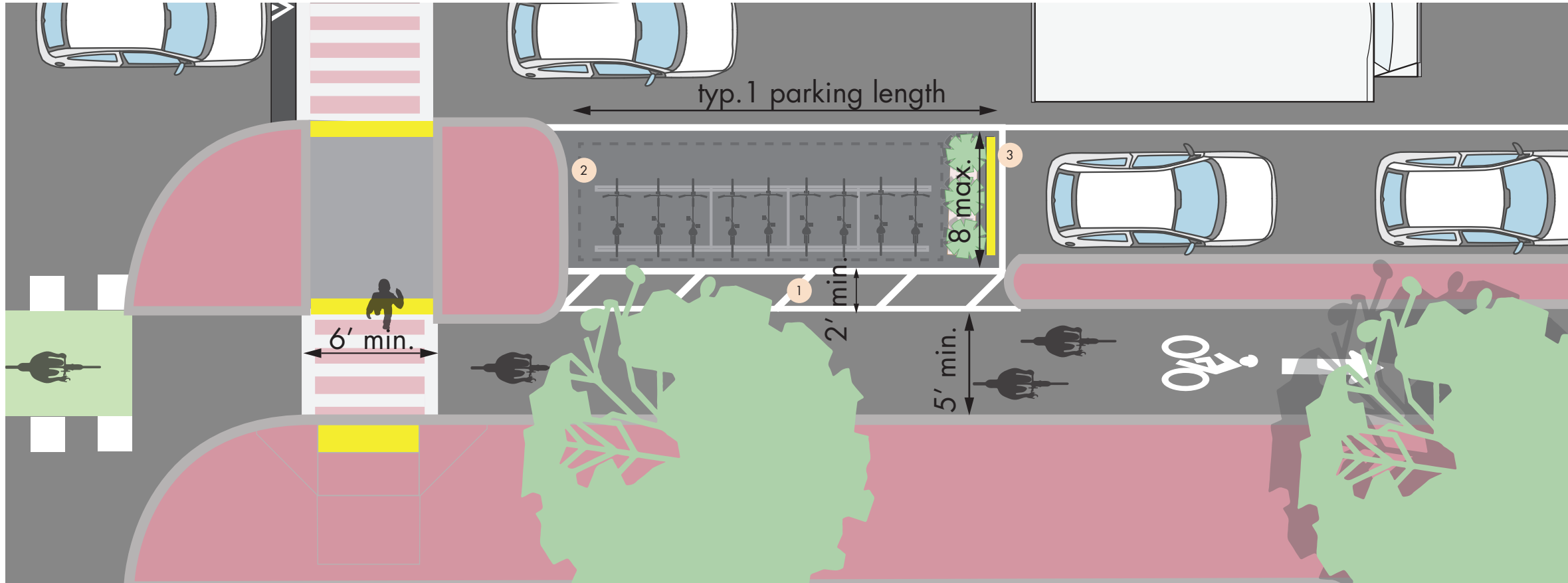

Fig 2.60 Bike Corral protected bike lane intersection approach.

- 1 Access aisle must match the length of parking space. A 2 ft minimum width is recommended
- 2 Consider providing shelter to the bicycle corral without obstructing the corner visibility triangle.
- 3 Stop bars and vertical elements should be used to differentiate motor vehicle parking from bike corral.

# BICYCLIST: PROTECTED BIKE LANES: MATRIX

| CORRIDOR SCALE DESIGN CONSIDERATIONS | <b>ONE WAY PROTECTED BIKE LANE</b><br> | <b>CONTRA-FLOW PROTECTED BIKE LANE</b><br>          | <b>ONE WAY PROTECTED BIKE LANE + CONTRA-FLOW PROTECTED BIKE LANE</b><br> | <b>TWO WAY PROTECTED BIKE LANE</b><br> | <b>ONE WAY PROTECTED BIKE LANE PAIR</b><br> | <b>TWO-WAY PROTECTED BIKE LANE</b><br> | <b>MEDIAN TWO WAY PROTECTED BIKE LANE</b><br> |
|--------------------------------------|---|---|---|---|--|---|--|
| <b>ACCESS TO DESTINATIONS</b>        | People on bicycle have limited access to the other side of the street.  | People on bicycle have limited access to the other side of the street.  | People on bicycle have full access to the other side of the street.   | People on bicycle have limited access to the other side of the street.  | People on bicycle have full access to the other side of the street.  | People on bicycle have limited access to the other side of the street.  | People on bicycle have limited access to the other side of the street.   |
| <b>NETWORK CONNECTIVITY</b>          | Does not address contraflow demand which may result in wrong way riding   | Bicyclists riding in the direction of traffic share a lane with motorists. May result in wrong way riding in the contraflow bike lane | Allows for two-way bicycle travel but contraflow crossings may be inefficient.  | Allows for two-way bicycle travel but contraflow crossings may be inefficient.  | Accommodates two-way bicycle travel  | Accommodates two-way bicycle travel   | Accommodates two-way bicycle travel  |
| <b>CONFLICT POINTS</b>               | Few. Turning drivers and pedestrians expect 1 way bicycle traffic   | Turning drivers and pedestrians may not expect contraflow traffic   | Turning drivers and pedestrians may not expect contraflow traffic   | Turning drivers and pedestrians may not expect contraflow traffic   | Few. Turning drivers and pedestrians expect concurrent bike riders   | Turning drivers and pedestrians may not expect contraflow traffic   | Turning drivers and pedestrians may not expect contraflow traffic. Median may improve visibility and reduce conflict             |
| <b>INTERSECTIONS</b>                 | May use existing signal phases, bike signal may be required depending on volumes  | Usually requires additional signal equipment. Bike phase may be required depending on volume  | Usually requires additional signal equipment. Bike phase may be required depending on volume  | Usually requires additional signal equipment. Bike phase may be required depending on volume                              | May use existing signal phases, bike signal may be required depending on volumes   | Usually requires additional signal equipment. Bike phase may be required depending on volume                              | Usually requires additional signal equipment. Bike phase may be required depending on volume                                     |

Fig 2.61 Protected bike lane configurations matrix.



## INTERSECTIONS/ JUNCTIONS

Intersections are the highest point of potential conflict between users. A well designed intersection is able to effectively communicate what each user must do in order to have a successful crossing. Good intersection design makes convergence points into a stress-free experience where certain elements are highlighted in order to increase visibility of users.

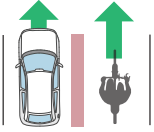
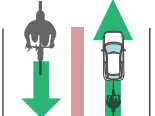
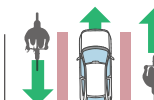
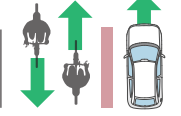
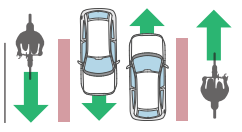
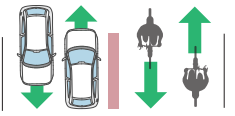
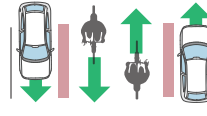
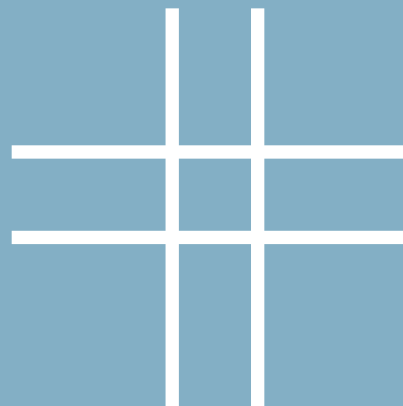
A successful intersection has the following characteristics:

- Clearly defined waiting zones for people in motorized vehicles, bicycles and on foot.
- Has accessible pedestrian signals (voice, tactile, and visual aid).
- Is as compact as possible, meaning that all users have the shortest possible distance to cross.
- Is designed with the hierarchy of users in mind for crossing priority. Pedestrians are the most vulnerable and potentially slow, followed by bicyclists and last, motor vehicles.
- Avoid extreme angles and complex movements.
- Pedestrians and bicycles must be routed through the intersection with minimum deviation from their direct path.
- Provide shade at and near junctions, particularly in areas where pedestrians are waiting to cross the street.

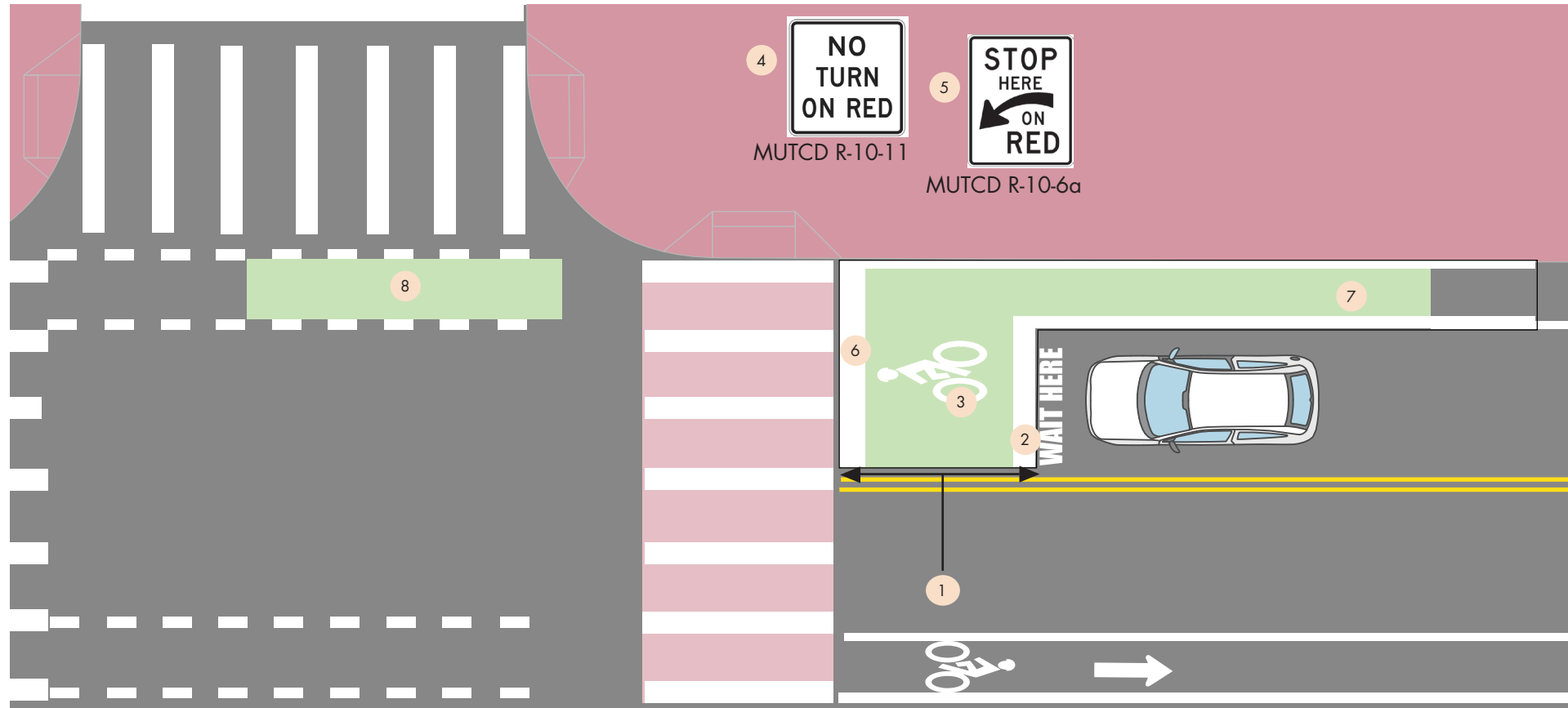

- 6 Colored pavement should be used within the bike box to encourage compliance by people traveling by motor vehicle.
- 7 An ingress lane should be used to define the bicycle space. Color pavement may be used. When color is used, length shall be 25' - 50' to guarantee bicyclists access to the box.
- 8 An egress lane should be used to clearly define the potential area of conflict between motorists and bicyclists at the intersection. An egress lane should not be used when there is no complimentary bike facility or lane on the far side of the intersection.

Fig 2.62 Bicycle box at intersection.

- 1 A box formed by transverse lines shall be used to hold bicyclist. Typically 10' - 16' deep. Deeper boxes show less encroachment by motor vehicles.
- 2 Stop lines shall be used to indicate the point behind which motor vehicles are required to stop in compliance with a traffic control signal.

- 3 Pavement markings shall be used and centered between the crosswalk line and the stop line to designate the space as a bike box. A "Wait Here" legend making may be used to supplement the MUTCD R-10-6a marking at bike box.
- 4 In cities that permit right turns on red signal indications, a "No Turn on Red" sign shall be installed overhead to prevent vehicles from entering the bike box.

- 5 A "Stop Here on Red" sign should be post-mounted at the stop line to reinforce observance of the stop line. Additional signs may be used to clarify signal control. Among the legends that may be used is : " Bikes Stop Here on Red"

\*Bike box treatments are most helpful when bicyclists arrive at a red signal, giving cyclists a head start at intersections and high visibility.



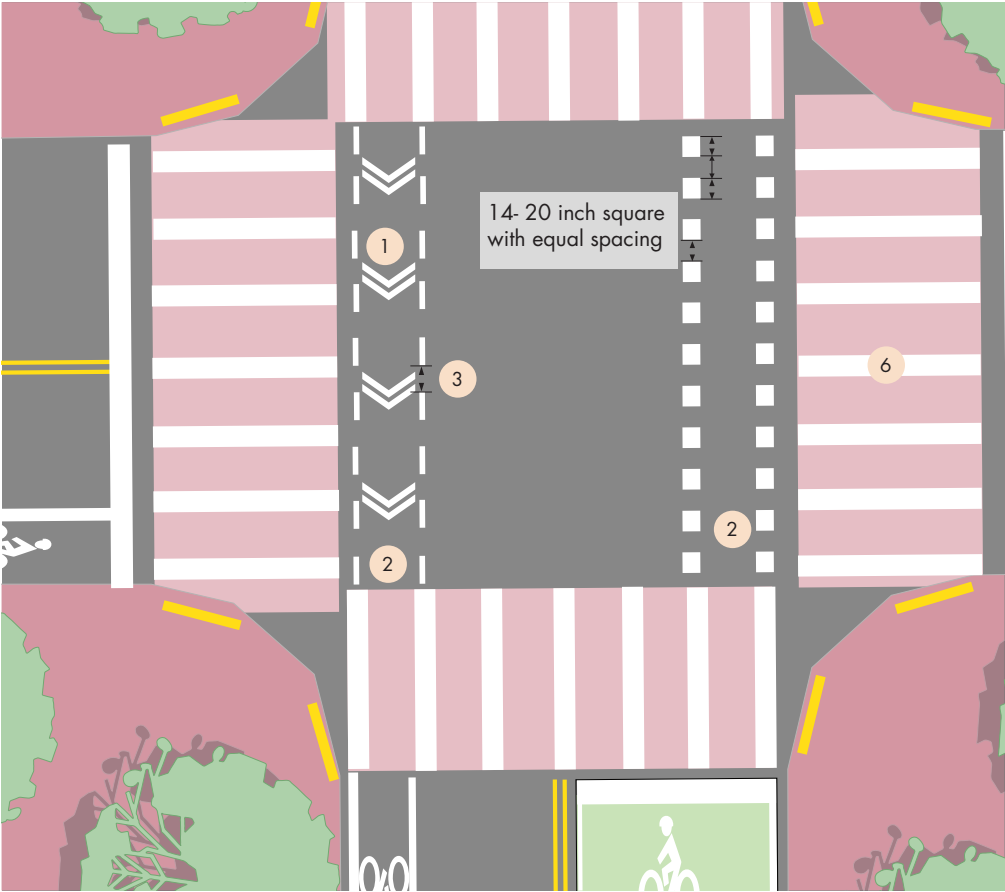

Fig 2.63 Pavement markings variations at intersection (a).

- 1 Chevrons might be used in conflict areas or across entire intersections.
- 2 Crossing lane width shall match width and position of the leading bike lane in all cases.
- 3 Dashed lines shall be 2' lines with 2' to 6' feet spacing. Markings shall be white, skid-resistant and retro reflective.
- 4 Shared Lane markings might be used in conflict areas or across entire intersections.
- 5 Colored pavement might be used in conflict areas or across entire intersections for increased visibility
- 6 Colored pavement might be used for increased visibility of pedestrian crosswalk

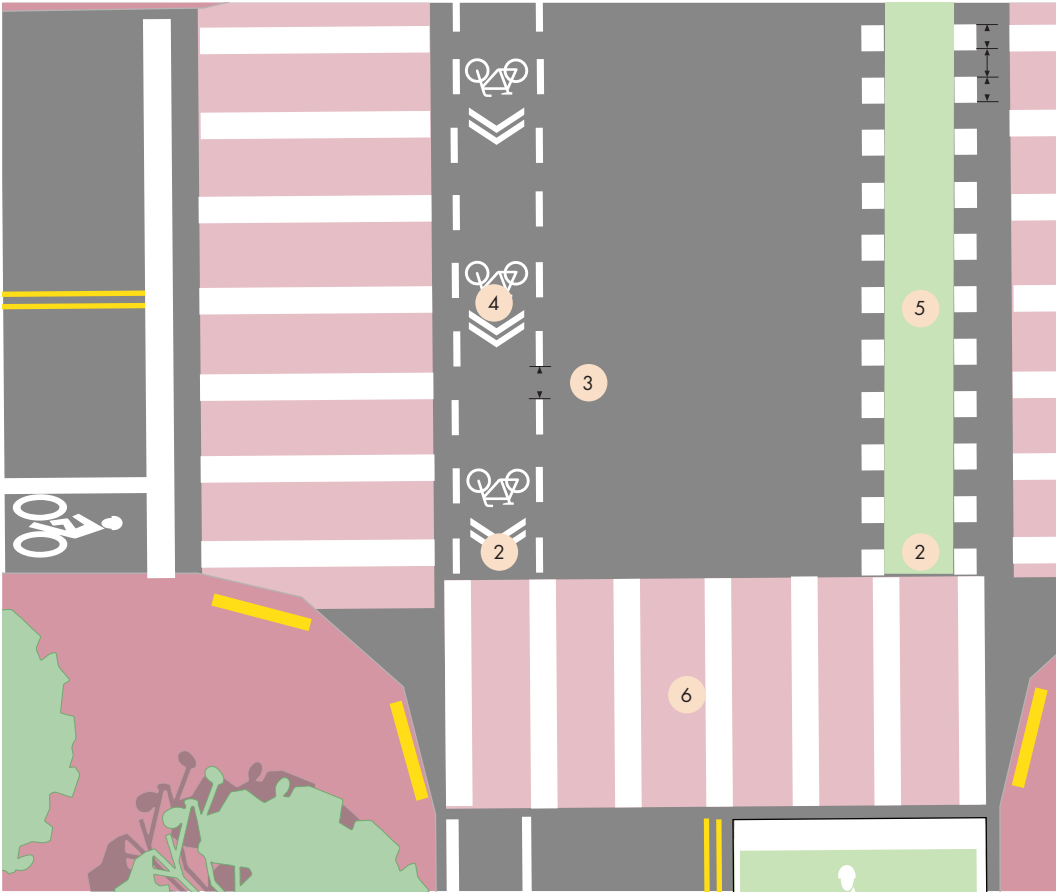

Fig 2.64 Pavement markings variations at intersection (b).

“Shark Teeth” yield markings may be used when crossing driveways and alley ways to mark the edge of the bike lane as well as in potential pedestrian/ bicycle conflict areas. People traveling by bicycle shall yield to pedestrians.

“Elephant Feet” markings may be used as an alternative to dotted line extensions to offer increased visibility

Yield lines for roadways

Yield lines for separated bike lanes

14"-20" squares with equal spacing.

## BICYCLIST: TWO STAGE LEFT/ QUEUE BOX\*

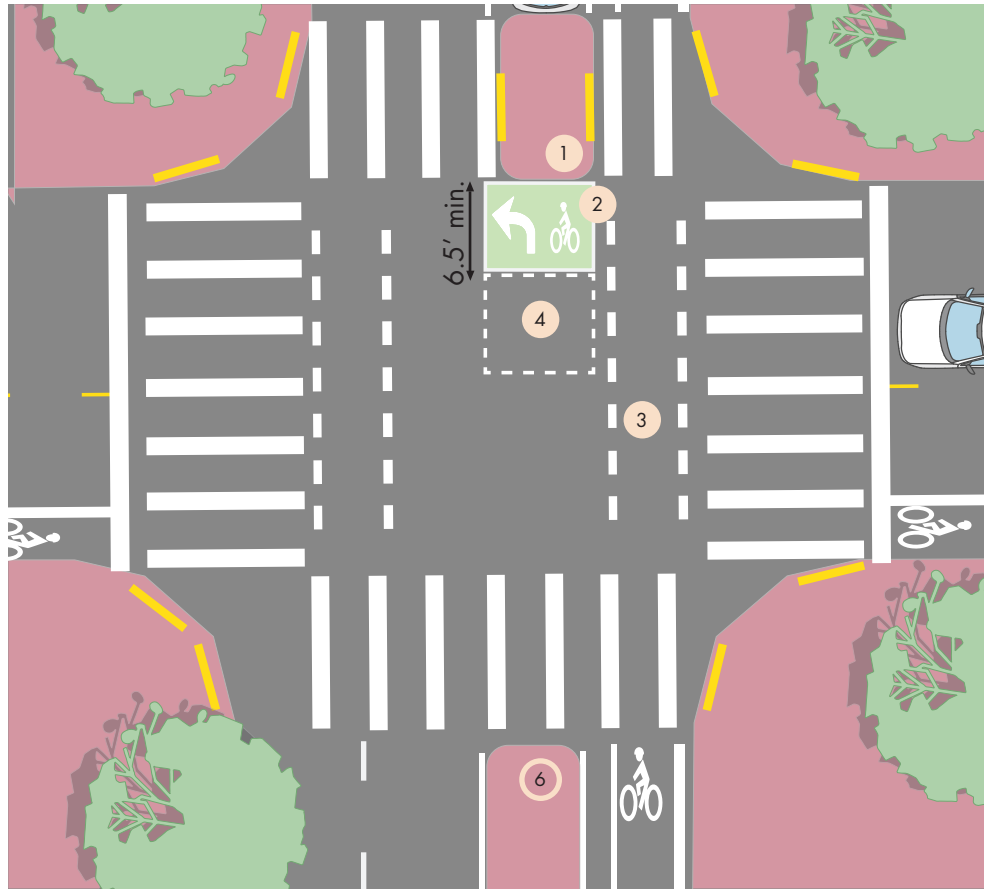

Fig 2.65 Two-stage left turn bike box at median.

- 1 An area shall be designated to hold queuing bicyclists and formalize 2-stage turn maneuvers.
- 2 Pavement markings shall include a bicycle stencil and a turn arrow to clearly indicate proper bicycle direction and positioning. In addition, the box shall be painted for improved visibility.
- 3 Markings across intersections should be used to define through bicyclist positioning.

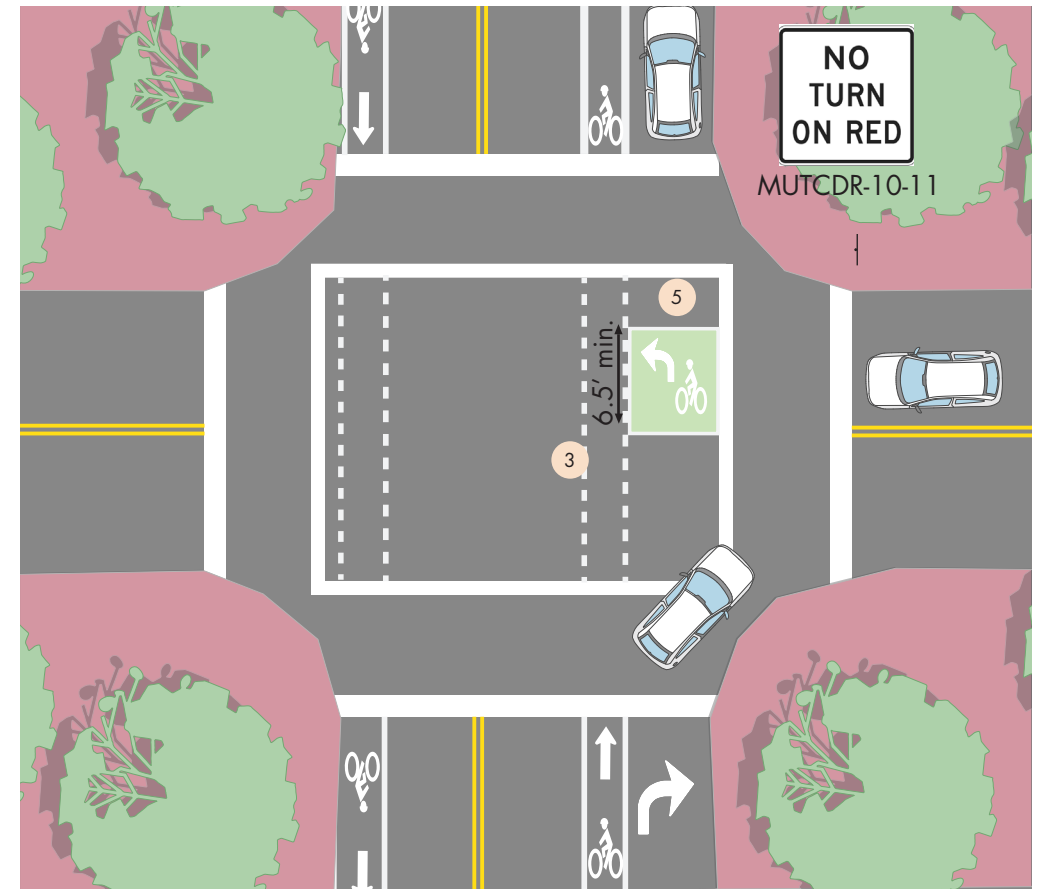

Fig 2.66 Two-stage left turn bike box at parallel parking configuration.

- 4 The queue box should be positioned laterally in the cross-street, to promote visibility of bicyclists.
- 5 The queue box may be positioned laterally in the cross street parking lane rather than in front of the travel lane. This may require bicyclists to weave into the travel lane to resume through movement of no dedicated bicycle facility is present since the parking lane ahead may be occupied.
- 6 When protected bike lane is configured as parking protected, consider dedicating bicycle parking space towards intersection.

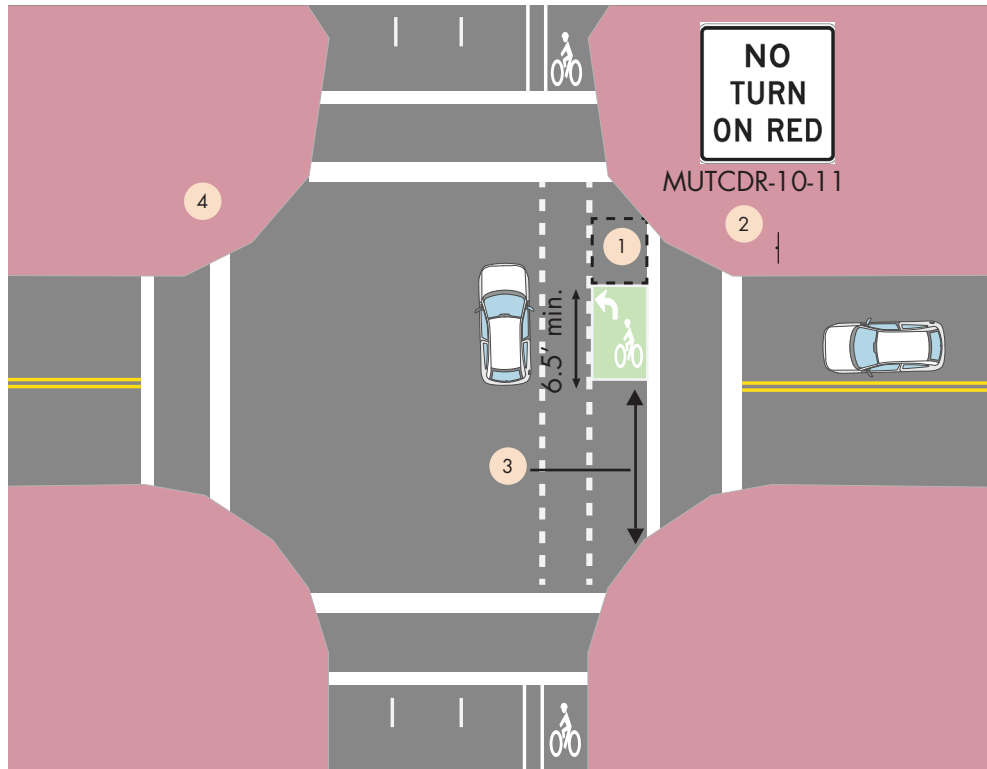

Fig 2.67 Two- stage left turn bike box and through bike lane configuration.

- 1 The queue box could be positioned laterally in the cross street parking lane rather than in front of the travel lane.
- 2 Wider corner radius and setback pedestrian crossing provide opportunity for bicyclist queuing area.
- 3 The queue box shall be placed in a protected area. Typically this is within and on-street parking lane or between the bicycle lane and the pedestrian crossing.
- 4 A “No Turn on Red” sign shall be placed overhead in cities where right turn on red is allowed.

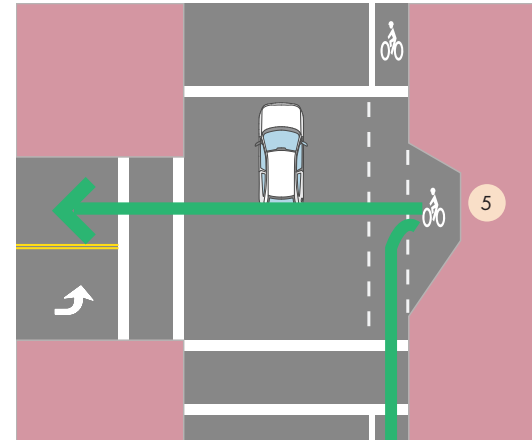

Fig 2.68 Two- stage left turn at mid-block.

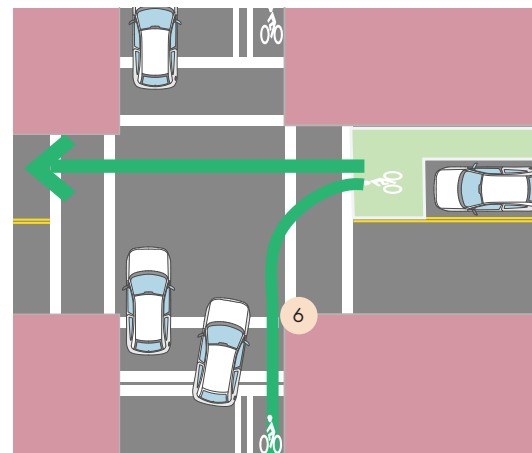

Fig 2.69 Two- stage left turn at bike box.

\*Two-stage left queue boxes are helpful on streets with longer green periods and streets where cyclists might be less comfortable turning left from a turn lane. It gives bicyclists a safe area to make a turn without conflicting with through traffic, unlike the bike box alone.

- 5 At mid-block turning locations, the queue box may be integrated into the sidewalk space. This configuration is also known as the “jughandle”. Consider the use of some form of signalization at these locations.
- 6 Bicycle box configuration. Bicycles yield to pedestrians. Not recommended in areas with high pedestrian volumes.



credit: SuOm Francis



credit: suOm Francis

## BICYCLIST: RIGHT-TURN-ONLY WITH TRAFFIC DIVERTER

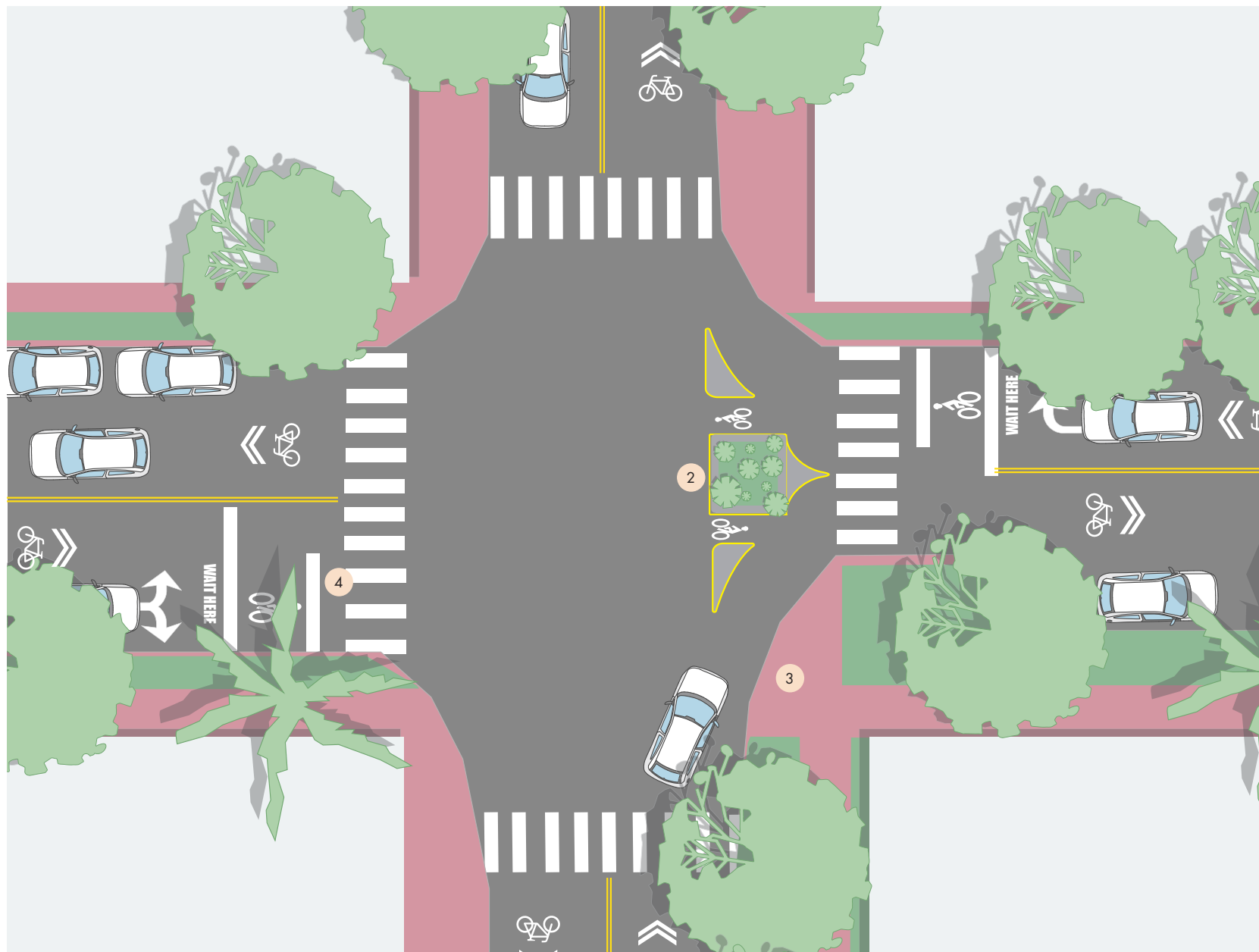

- 1 Appropriate education for use of proposed treatments should be provided to neighbors and others who are likely to use the corridor.
- 2 Closures and diverters should be liberally marked to alert drivers to expect bicyclists emerging from or not turning at the feature.
- 3 Supplemental signage and markings should be provided at crossings of major roads to improve crossing visibility.
- 4 A forward stop bar should be provided for bicyclists at minor crossings in order to increase visibility and reduce crossing distance. Minimum requirement when other geometric treatments are not immediately implementable.

Fig 2.70 Right turn-only movement with traffic diverter.

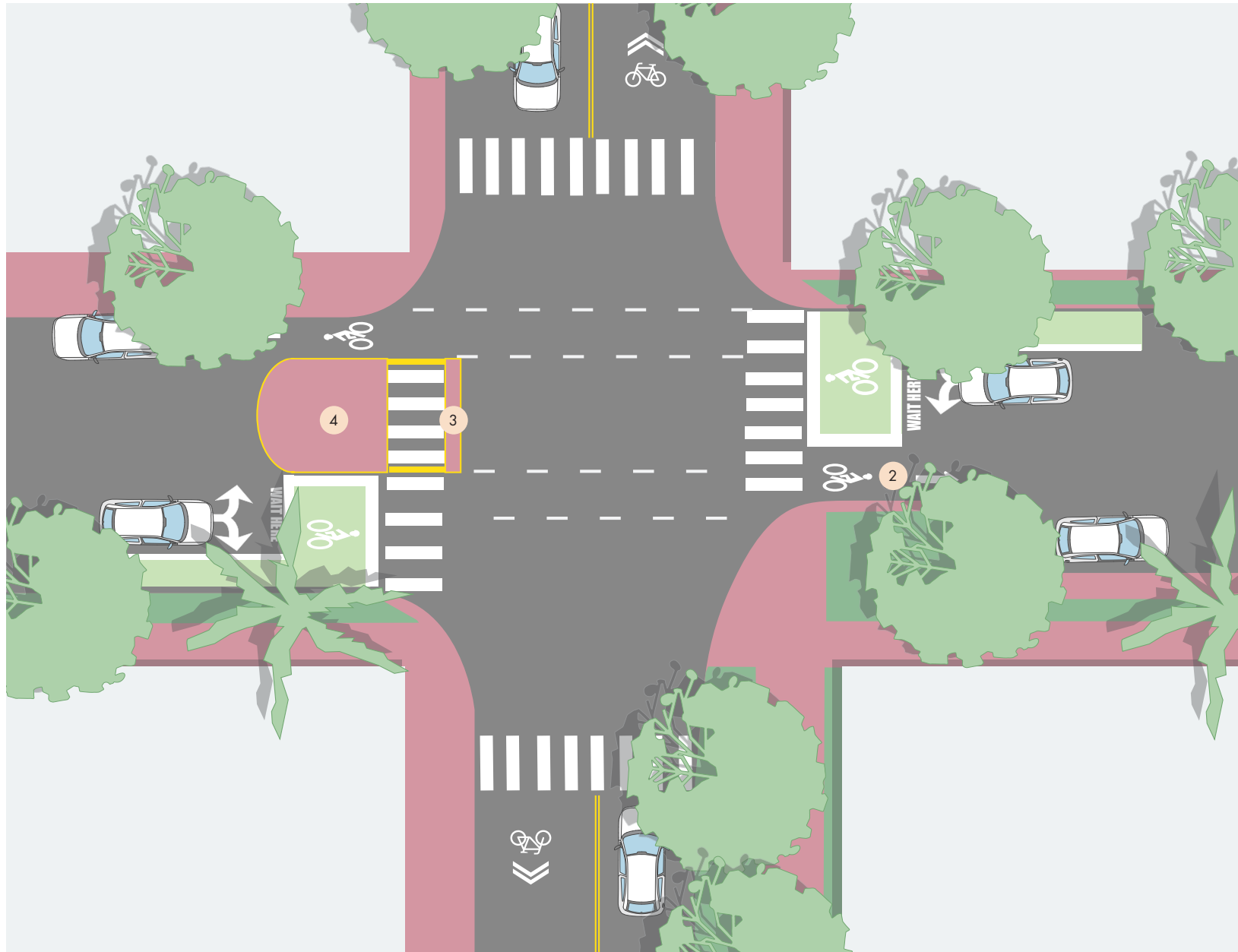

- 1 Treatments should be selected based on the numbers of existing gaps and the selected gap profile.
- 2 Volume management should be considered at signalized intersections along the bicycle boulevard to discourage motorists for using route.
- 3 Supplemental signage and markings should be provided at crossings of major roads to improve crossing visibility.
- 4 Geometric elements like median refuge islands, curb extensions, neckdowns, and raised crosswalks may be provided to improve sight distances for bicyclists and drivers

Fig 2.71 Bike box with partial closure configuration.

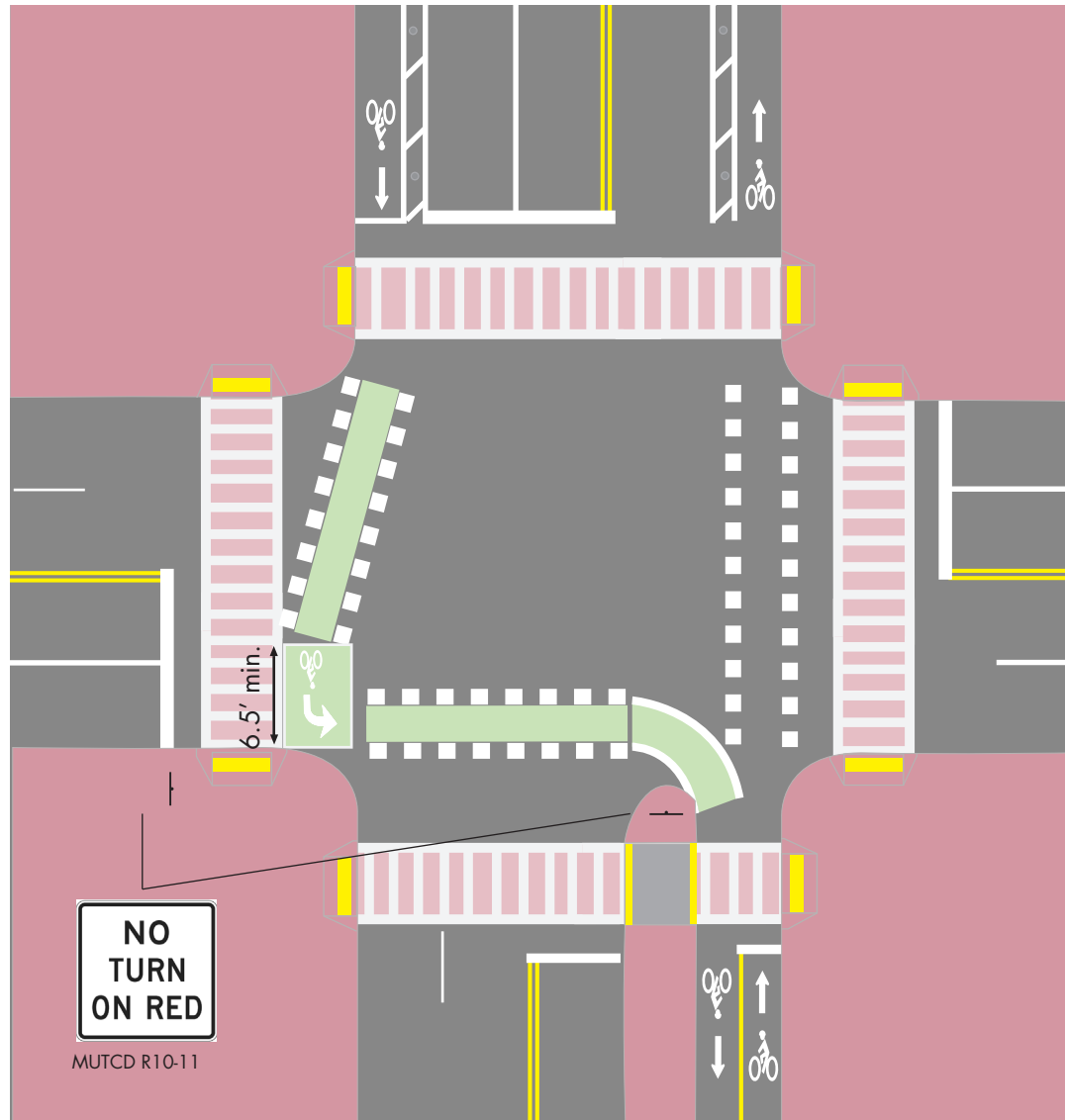

Fig 2.72 Bicycle facilities transition (a)

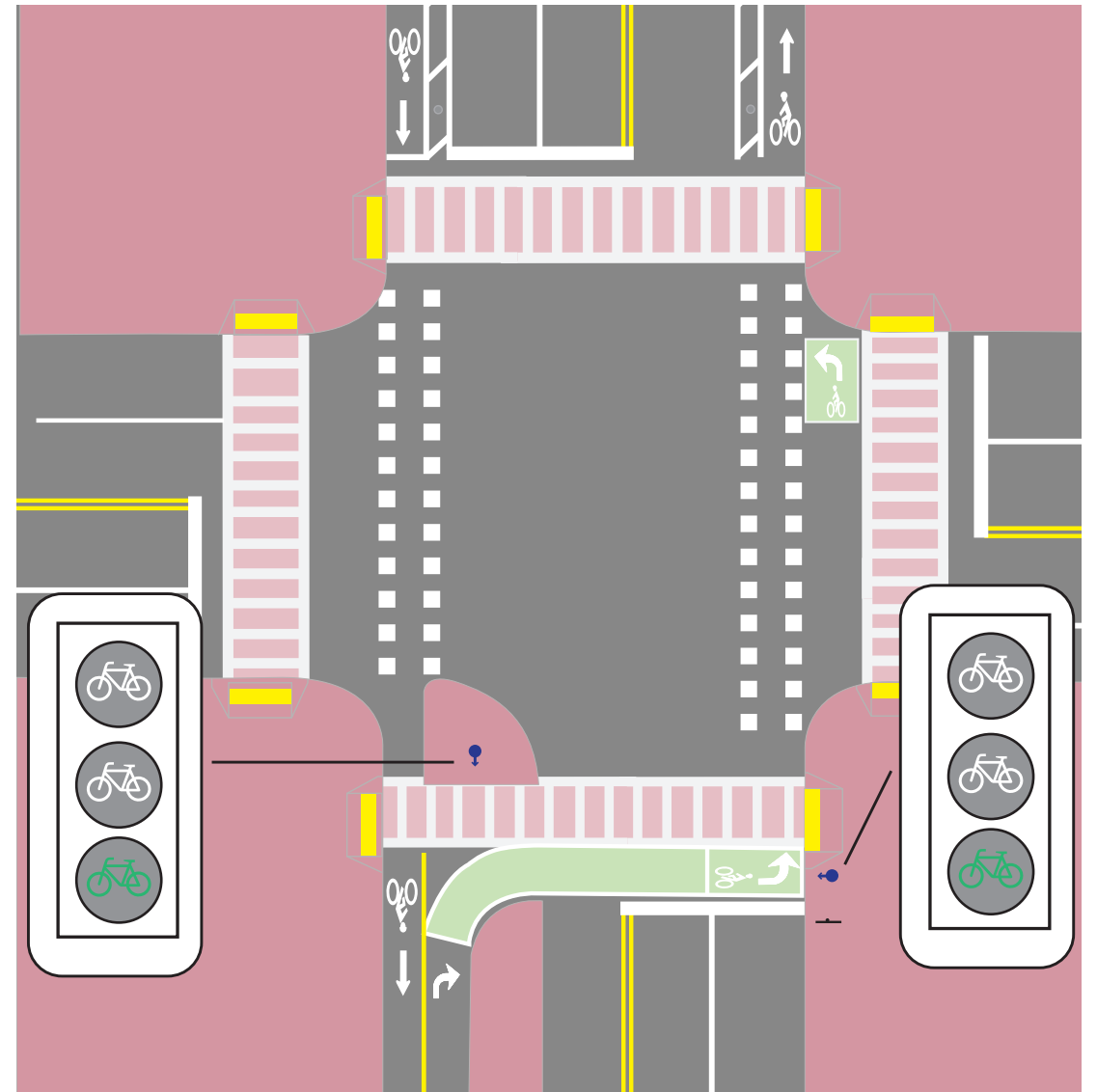
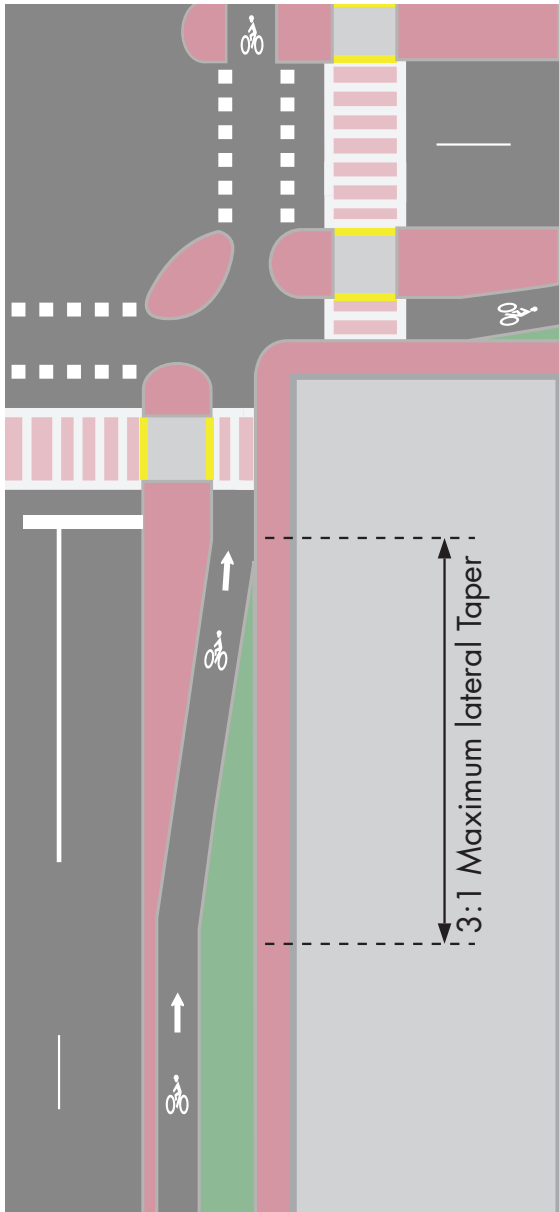

Fig 2.73 Bicycle facilities transition (b)

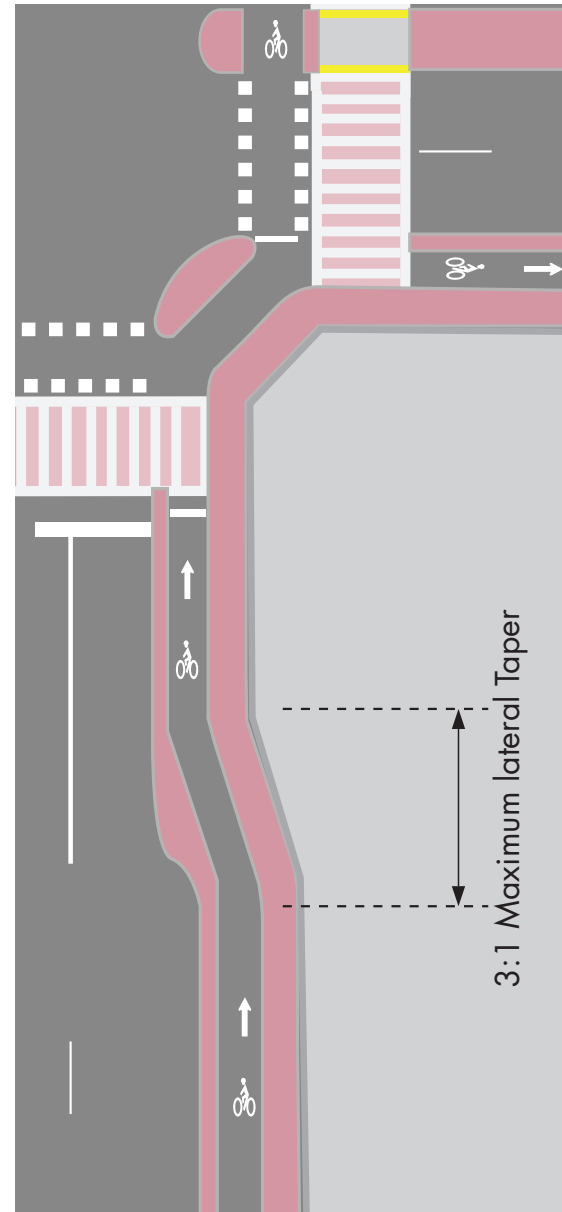

Fig 2.74 Protected bike lane bend-out condition.



**BEND-OUT CONSTRAINED CONDITION**

Fig 2.75 Protected bike lane bend-in condition



**BEND-IN CONSTRAINED CONDITION**

At constrained locations, it may not be possible to maintain the preferred widths of travel lanes, buffers, bike lanes, and sidewalks to the corner. (Sidewalk widths must comply with ADA requirements). Sometimes, it may be necessary to narrow a zone to the minimum dimensions or to eliminate the sidewalk buffer in order to achieve the desired design. At locations where there are no conflicts with turning vehicles, the street buffer can be minimized and the motorist yield zone can be reduced or eliminated.

If a lateral shift of the bicycle facility is required, the maximum taper allowed is 3:1.

**BEND-OUT DEFLECTION**

- Allows for greater queuing areas for bicyclists and pedestrians within the protected intersection.
- Desirable where is necessary to provide a pedestrian platform for transit stops or queuing space for parking and loading.
- Provides greater yielding area for motorists

**BEND-IN DEFLECTION**

- Recommended only in cases where sidewalk width minimums must be maintained in conditions that require the elimination of sidewalk buffers and narrowing of street buffers.
- A motorist yield zone is provided by enlarging the corner island.

Fig 2.76 Protected intersection.

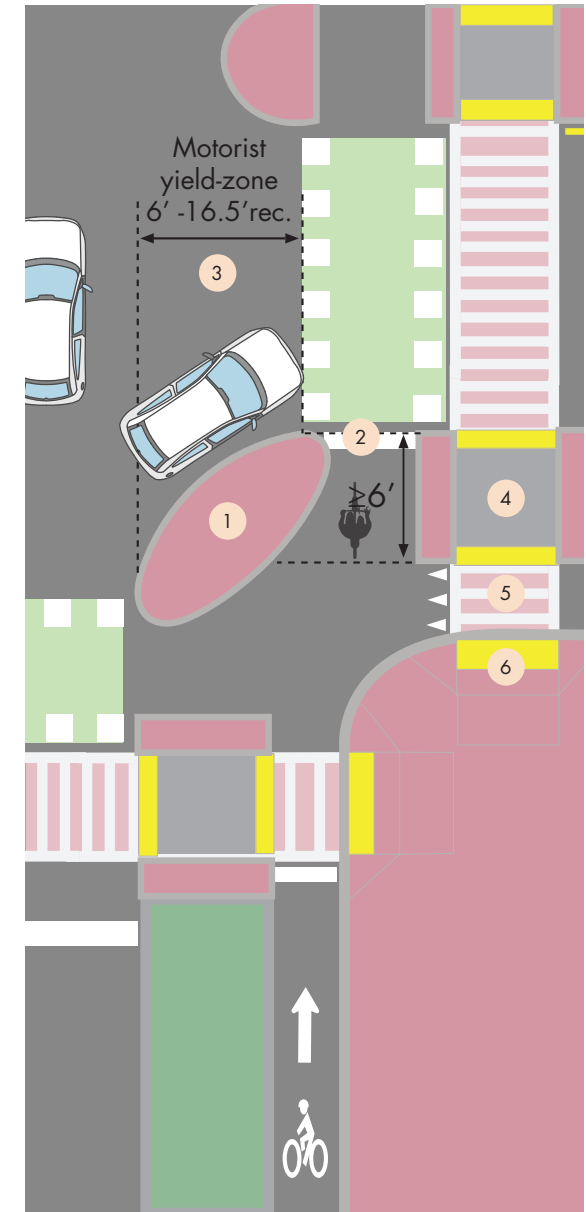

**PROTECTED INTERSECTION**

# BICYCLIST: PROTECTED BICYCLE FACILITIES TRANSITION

## PROTECTED INTERSECTION ELEMENTS

- 1 Corner Refuge Island:
  - Creates a bicycle queuing area.
  - Creates a motorists storage area
  - Reduces Ped/Bike crossing distances
  - Controls motorists crossing speeds
  - If design exceeds an SU-30, a mountable truck apron should be considered.
- 2 Forward Bicycle Queuing Area:
  - Provides high visibility to cars waiting at the stop bar before turning.
  - Enables bicyclists to enter the intersection before motorists thus establishing a right of way similar to a leading bicycle interval.
  - Typical length and width should be a minimum of 6 feet, size should reflect demand.
- 3 Motorist Yielding Zone:
  - Crossing setbacks provide a safe yielding distance for pedestrians and bicyclists resulting in crash reduction benefits.
  - Bicycle and pedestrian crossings should be separate but parallel in order to consolidate potential conflicts for motorists. ( does not apply to shared paths).
- 4 Pedestrian Crossing Island:
  - It should be a minimum of 6' with detectable warning strips on each end.
  - Reduces the likelihood of pedestrians crowding the bike lane while waiting for a walk signal.
- 5 Pedestrian Crossing of Protected Bike Lane:
  - Pedestrian crossings communicate the clear message that bicyclists must yield to pedestrians.
  - Direct pedestrians to specified crossing locations thus reducing the likelihood of pedestrians crossing the bike lane at unmarked locations.
- 6 Pedestrian Curb Ramp:
  - Should be provided wherever there is a change in elevations.
  - The ramp must comply with ADA standards.
  - Detectable warning signals must be provided at the edges of all street and bike crossings.
- 7 Mountable Truck Aprons:
  - Create a safer intersection approach for large turning vehicle where a large curb radius is necessary.
  - The mountable area should be distinct in color from the travel way, separated bike lane, and refuge island.
  - The height of the mountable area should be a maximum of 3 inches.
  - The mountable surface is considered part of the travel way and its design should discourage pedestrians and bicyclists from using it as a refuge.

Fig 2.77 Set back crossing.

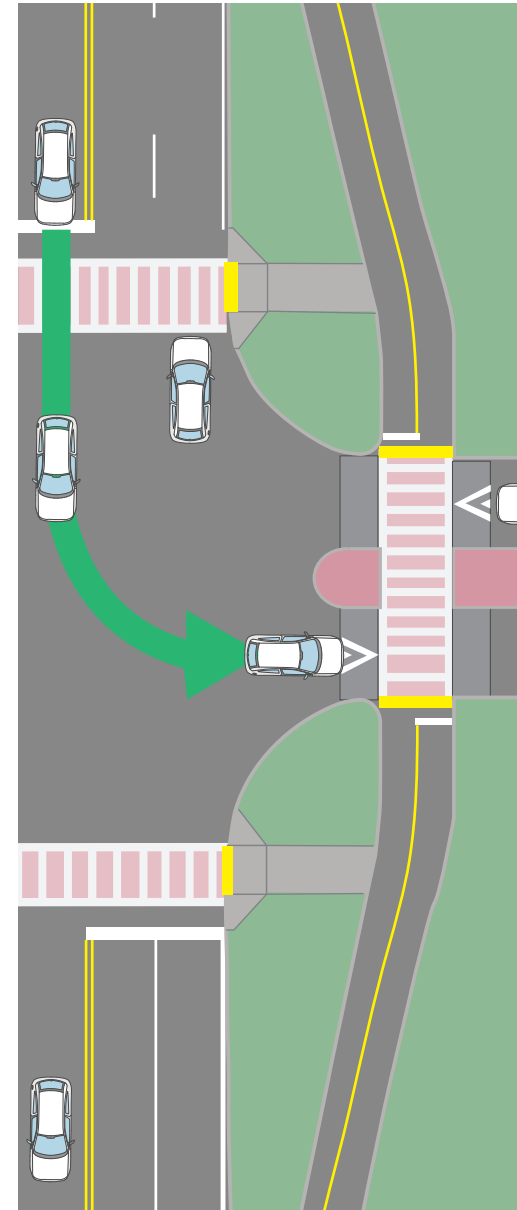

**SET BACK CROSSING CONDITION**

Fig 2.78 Mountable truck apron.

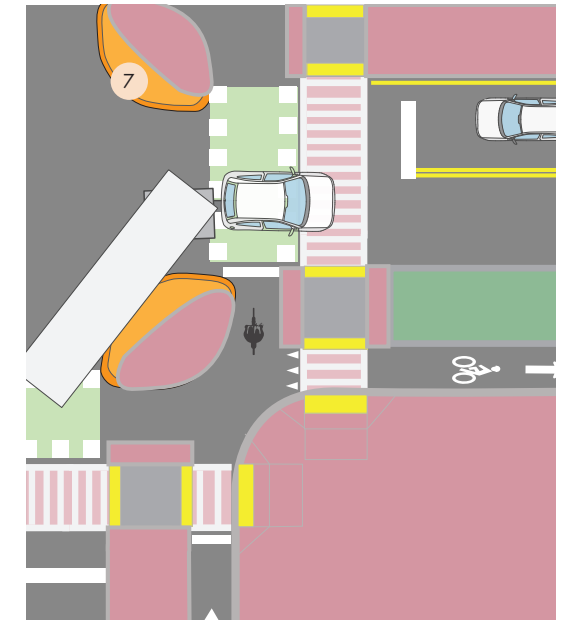

## SET BACK CROSSINGS

- When crossings are set back, as mentioned in the motorist yielding zones (3), the result is an increase in yielding distance and motorist reaction time to crossing pedestrians and bicyclists.
- The typical setback is about one car length.
- Shared path crossings do not require separate crossings for pedestrians and bicyclists.

Fig 2.79 Vehicle visibility of bicyclist intersection approach.

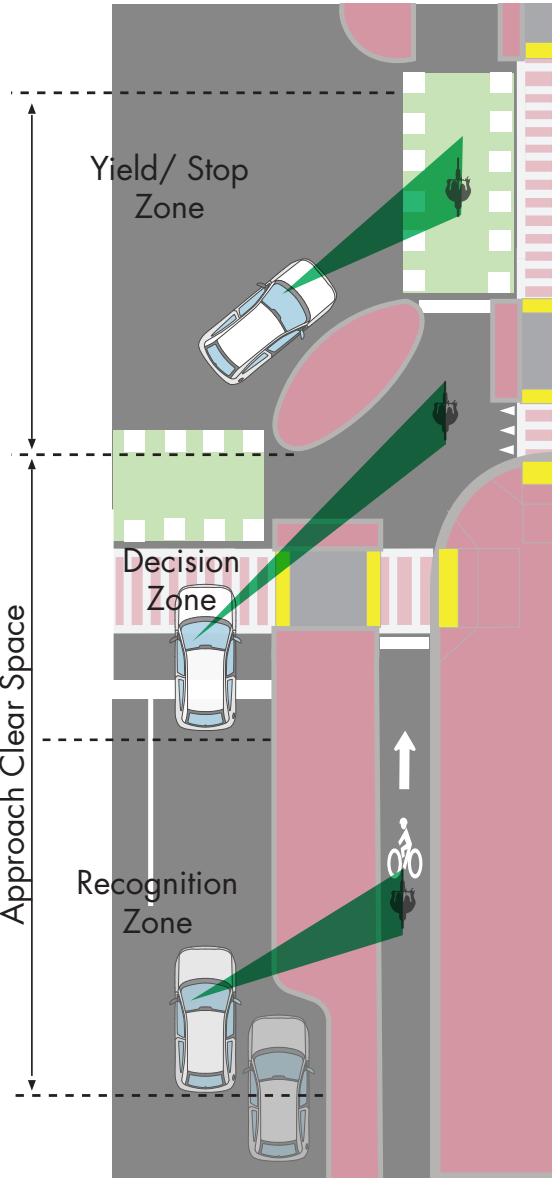

**RIGHT TURNING DRIVERS YIELD TO BIKES**

Fig 2.80 Bicyclist visibility of motor vehicle at intersection approach.

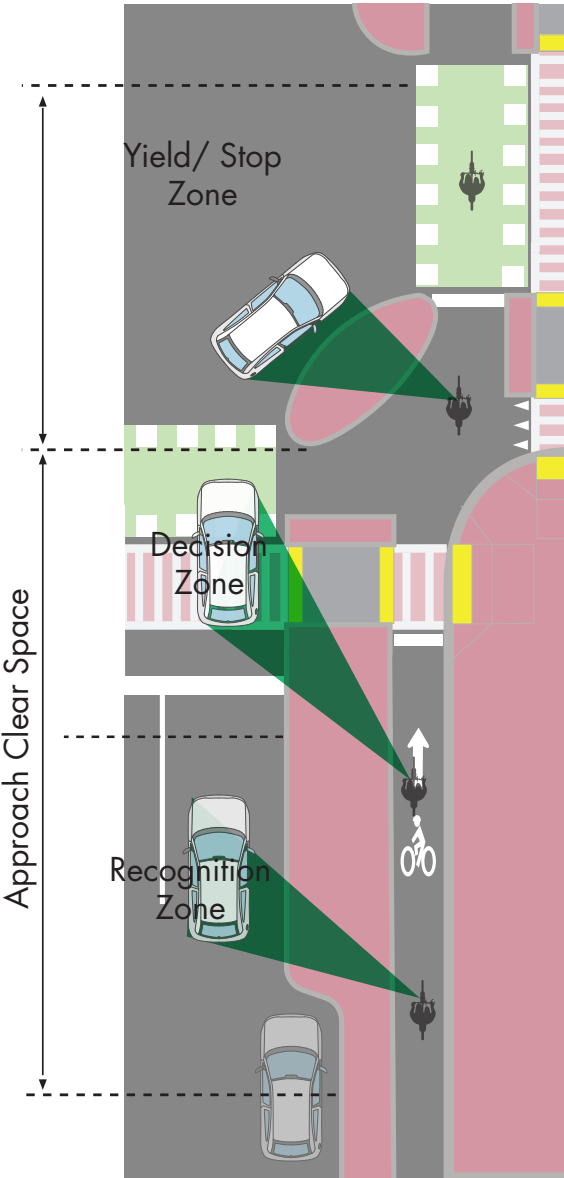

**THROUGH BIKES YIELD TO TURNING DRIVERS**

**RIGHT TURNING DRIVERS YIELD TO BICYCLISTS:**  
 This occurs when a through moving bicyclist arrives at the crossing before a turning motorist who must stop or yield to the through bicyclist. On street parking setbacks must be sufficient in order to provide adequate sight distances for both bicyclists and drivers.

**THROUGH MOVING BICYCLIST YIELDS TO TURNING DRIVER**  
 This occurs when a turning driver arrives at the crossing before a bicyclist; the bicyclist must wait at the forward stop bar and yield to the turning vehicle before resuming through movement. In this case, on street parking setbacks must also be sufficient in order to provide adequate sight distances for both the cyclist and the driver.

**APPROACH CLEAR SPACE: SIGHT DISTANCE**  
 The recommended approach clear space assumes that bicyclists are traveling at a constant speed of 15 mph. Recommendations for turning motorist assume a turning speed of 10 - 20 mph depending on the geometry of the corner and the travel path of the driver. The recommended sight distances allow 1 second of reaction time by both parties as they approach the intersection.

| VEHICULAR TURNING SPEED | APPROACH CLEAR SPACE |
|-------------------------|----------------------|
| 10 mph                  | 40 ft                |
| 15 mph                  | 50 ft                |
| 20 mph                  | 60 ft                |

## PEDESTRIAN/ BICYCLIST: MEDIAN REFUGE ISLAND

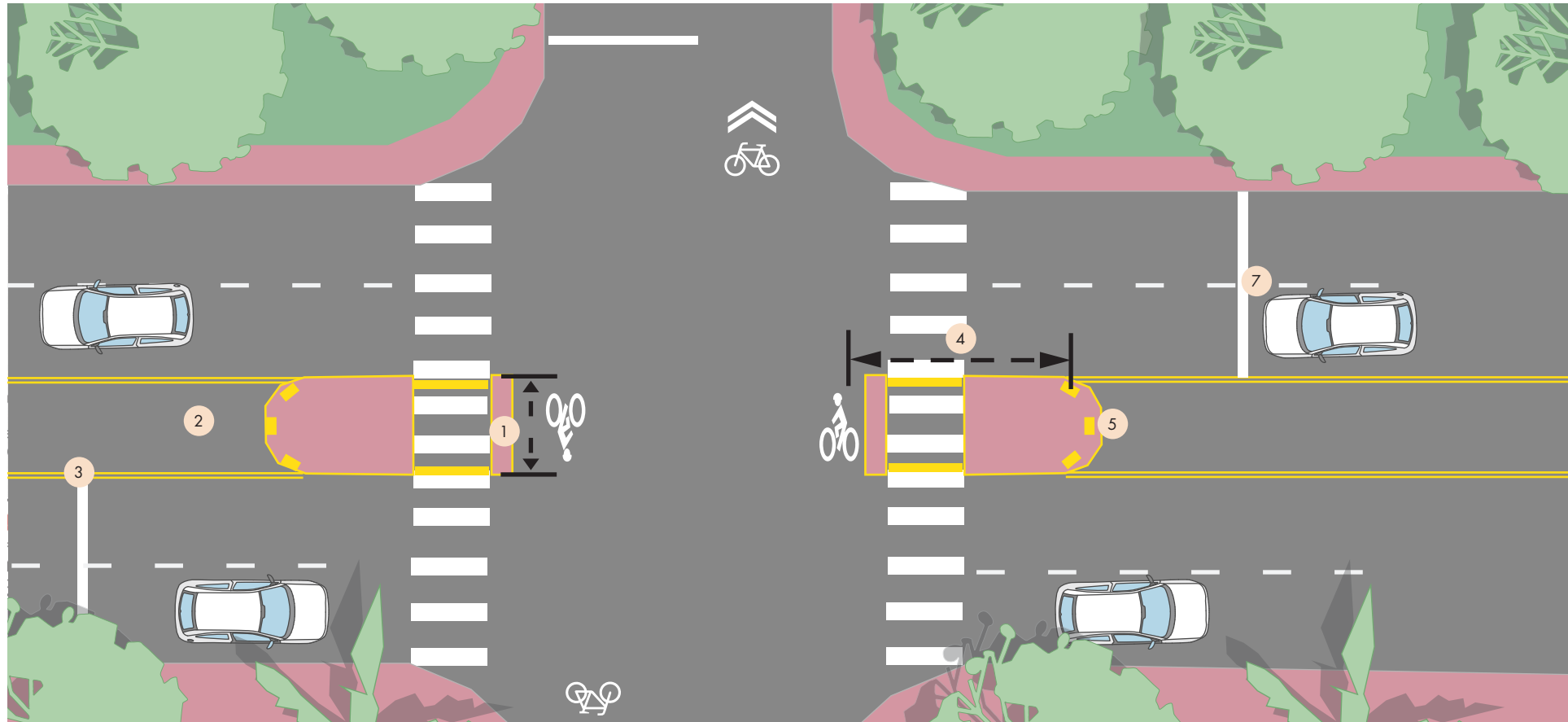

Fig 2.81 Pedestrian and Bicyclist median refuge island.

- 1 The desirable width of the median refuge is 10' or greater. The absolute minimum is 6'.
- 2 When applied on a two-way street, the median refuge shall be placed along the centerline of the roadway between the opposing directions of travel.
- 3 Pavement markings on the approach to the refuge island shall follow guidance provided in section 31.02 of the MUTCD
- 4 The length of the refuge island should be greater than 6'.
- 5 Reflective markers should be used on the approach to the nose of the island's curb.
- 6 The refuge area should be wide enough to accommodate two-way bicycle traffic.
- 7 Advanced stop signs and markings may be included to increase awareness of pedestrian/bicycle crossing.

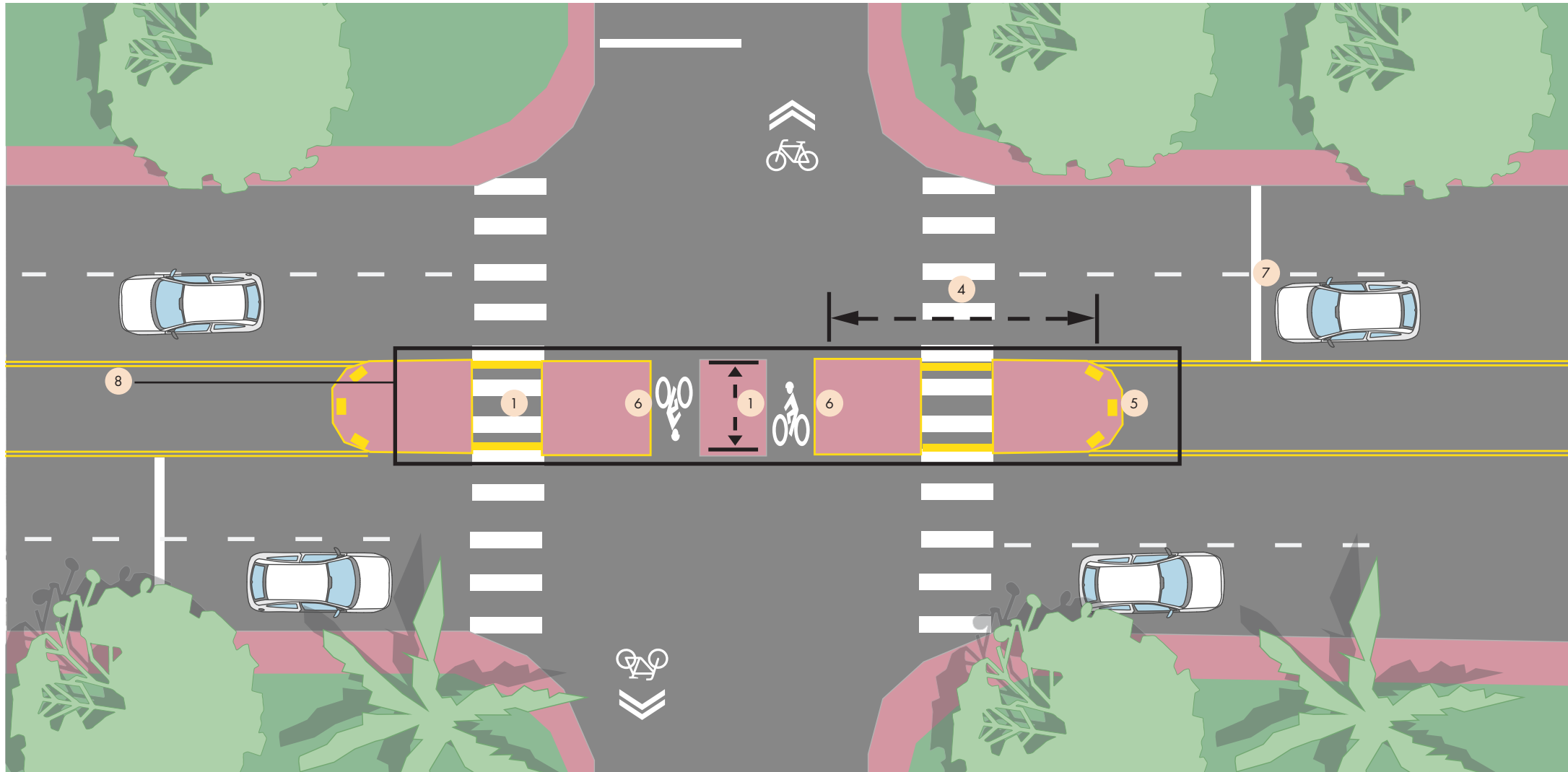

Fig 2.82 Pedestrian and Bicyclist median refuge island with full closure.

- 8 The median refuge can be carried across an entire cross street approach to act as a diverter to prevent cut-through traffic on bicycle routes

## PEDESTRIAN/ BICYCLIST: ROUNDABOUT

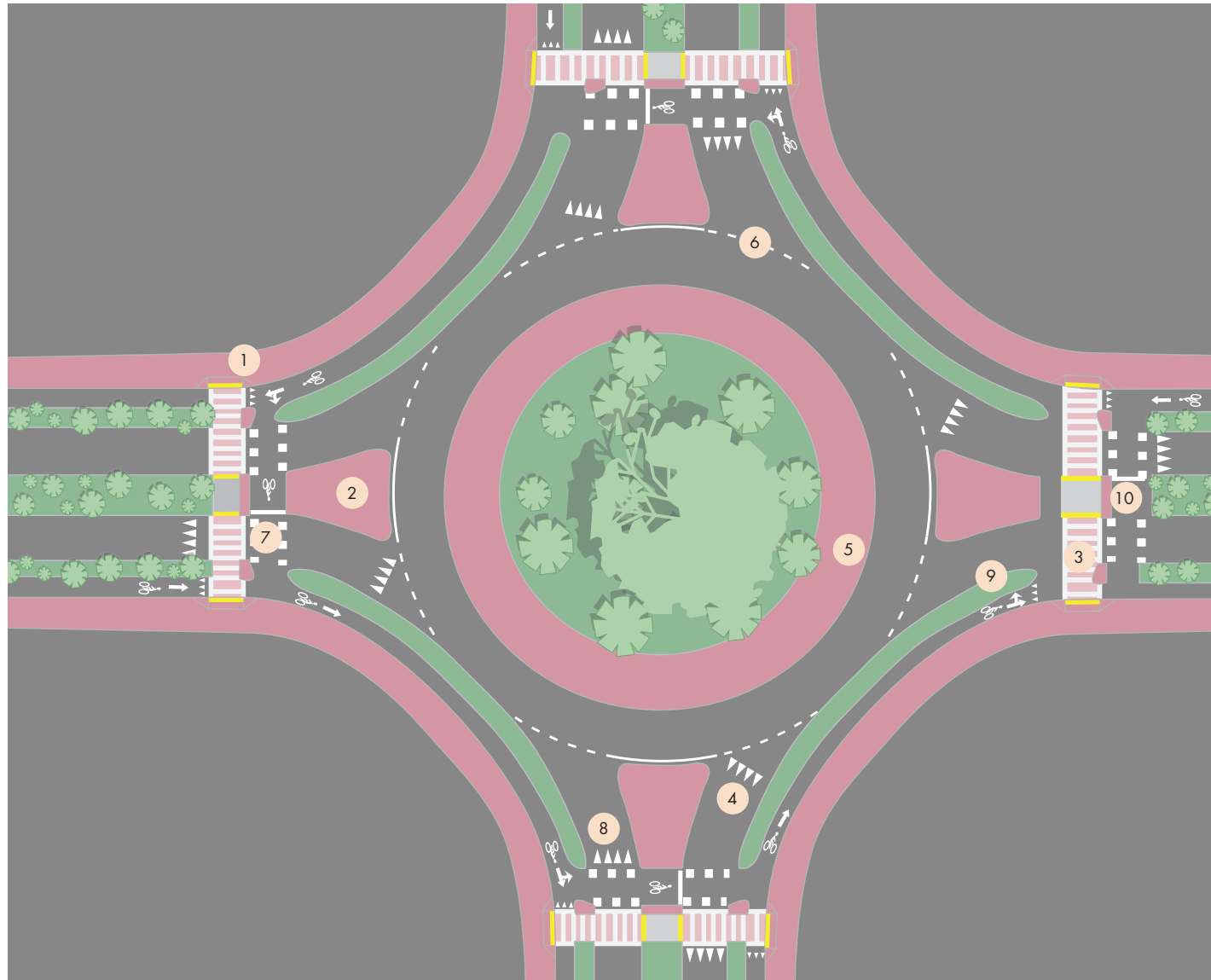

Fig 2.83 Typical roundabout with pedestrian crossings and separated bike facilities.

Roundabouts are common a common traffic calming method. They can be used in main streets as well as in a neighborhood context (1) in order to slow down motorized traffic and reduce the incidence of “cut through” traffic.

In addition to slowing down traffic, roundabouts provide a great opportunity for adding greenery to the urban context. Shade trees help reduce the heat island effect and provide habitat for birds and other animals. Water elements like fountains are also commonly used as central elements in roundabouts (3). Large roundabouts can often be configured as small plazas and enhance opportunities for social interaction, provide a focal point for the community, beautify and intersection and enhance the neighborhood’s character through landscaping and/or public art (2).

- 1 Separated sidewalks direct pedestrians to crosswalks.
- 2 Splitter Islands/ Medians, serve as pedestrian refuges and direct traffic in the right direction.
- 3 Pedestrian crossings are located one car length away from the roadway in order to shorten pedestrian crossing distance and enhance pedestrian visibility.
- 4 Slow speed entry / Yield movement.
- 5 Deflection ensures slow speed movements through out intersection.
- 6 Slow Speed exit/ Yield movement.
- 7 Bicycle crossing should be adjacent to pedestrian crossing and maintain the same elevation.
- 8 Additional yield signs at exits should be considered to highlight crossings
- 9 Curb radius should be a minimum of 5 ft.to enable bicyclists to turn into the queuing area
- 10 Channelizing islands are preferred to maintain separation between bicyclists and pedestrians, but may be eliminated if different surface materials are used.



| SPRAWL TYPES   | TECHNIQUES  | COMPLETE INTERSECTIONS  |   |
|--|---|---|---|
| <p><b>ARTERIAL</b></p>    | <ul style="list-style-type: none"> <li>• Replace conventional suburban intersections with urban intersections.</li> <li>• Reduce lane widths.</li> <li>• Introduce access lanes</li> <li>• Introduce medians.</li> <li>• Introduce parallel parking.</li> <li>• Introduce Transit.</li> <li>• Assemble public frontages according to street type.</li> <li>• Introduce appropriate bikeway intersection enhancements</li> </ul> | <p><b>BOULEVARD/ AVENUE</b></p>      | <p><b>BOULEVARD/ AVENUE</b></p>      |
| <p><b>COLLECTOR</b></p>  | <ul style="list-style-type: none"> <li>• Reduce number of lanes.</li> <li>• Reduce curb radii.</li> <li>• Introduce a median.</li> <li>• Introduce parallel parking</li> <li>• Assemble public frontages according to street type</li> <li>• Introduce appropriate bikeway intersection enhancements.</li> </ul>  | <p><b>MAIN STREET/ AVENUE</b></p>   | <p><b>MAIN STREET/ AVENUE</b></p>   |
| <p><b>LOCAL</b></p>     | <ul style="list-style-type: none"> <li>• Reduce curb radii.</li> <li>• Reduce lane widths.</li> <li>• Introduce parallel parking</li> <li>• Assemble public frontages according to street type.</li> <li>• Introduce appropriate bikeway intersection enhancements.</li> </ul>  | <p><b>NEIGHBORHOOD STREET</b></p>  | <p><b>NEIGHBORHOOD STREET</b></p>  |

Fig 2.84 From sprawl to complete intersections matrix.

Countermeasures as shown in the previous pages can vary greatly. Their effectiveness and appropriate use depends on the context of the street(s) within the network, and the ultimate goal for modeshare shift.

**BORDER RESTRICTIONS**

Prohibiting parking at the center of a district and/or directing all parking in the form of on street parking or structures to the border, tends to increase trips by foot and bike.

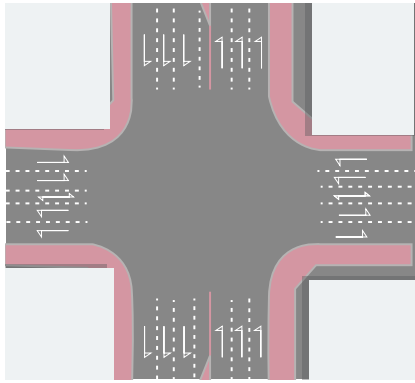
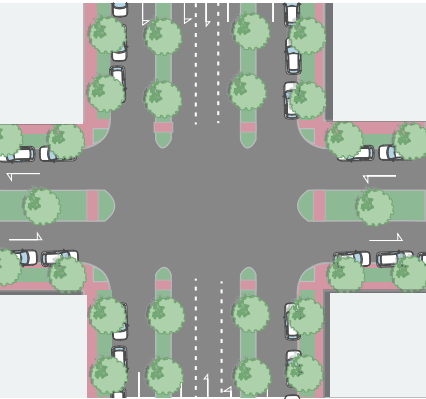
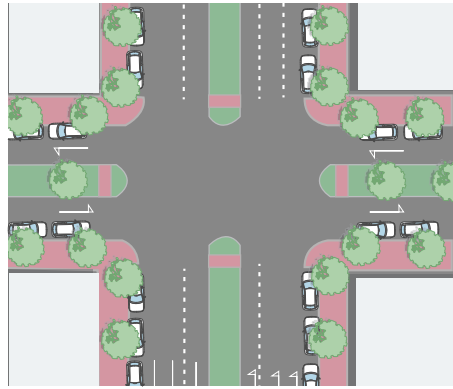
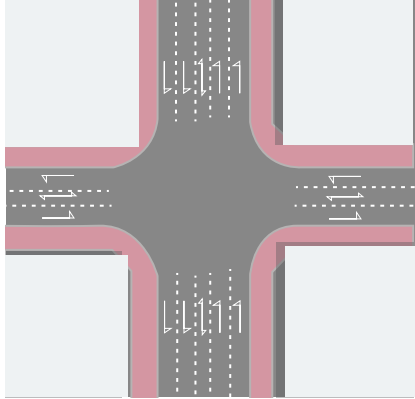
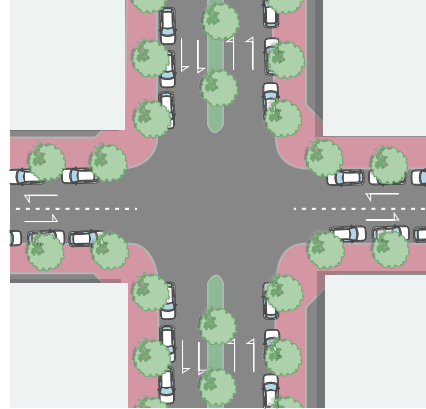
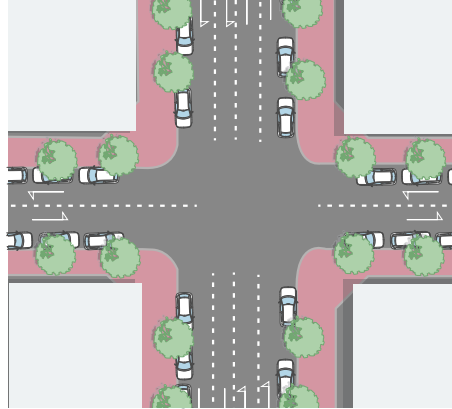
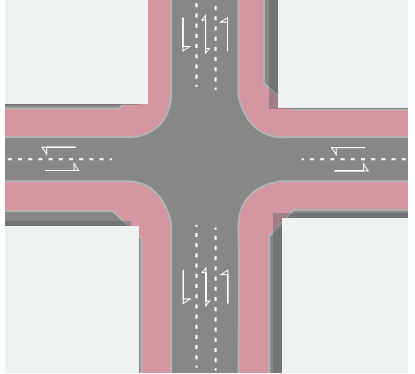
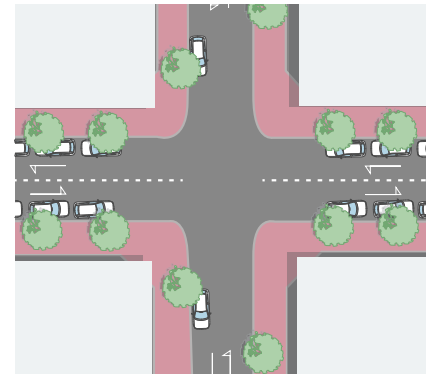
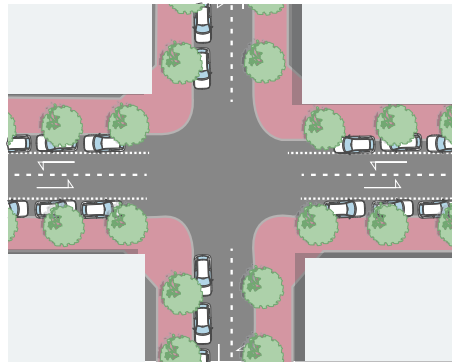
**INTERNAL DETOURS**

Partial closings, detours of internal traffic at certain times of the day or specified days of the week. Physical and permanent street closures shall only apply to motor vehicles and maintain adequate pedestrian and bicycle access.

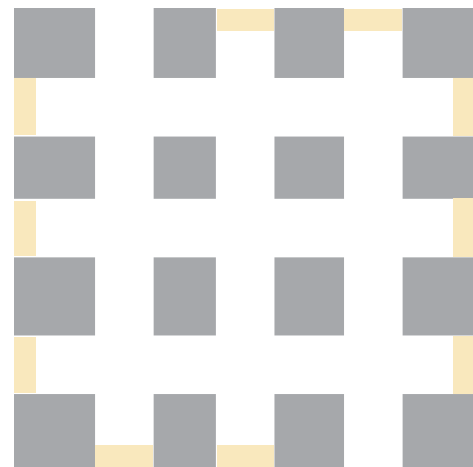

Border restrictions\*

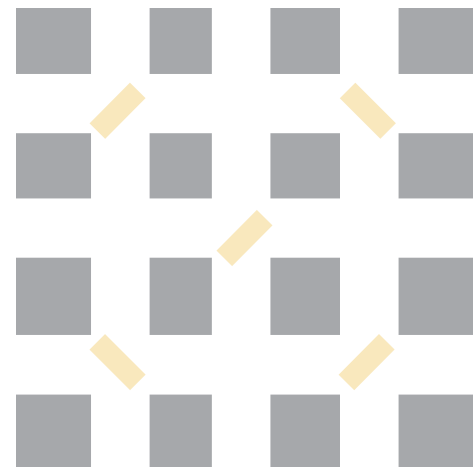

Internal detours\*

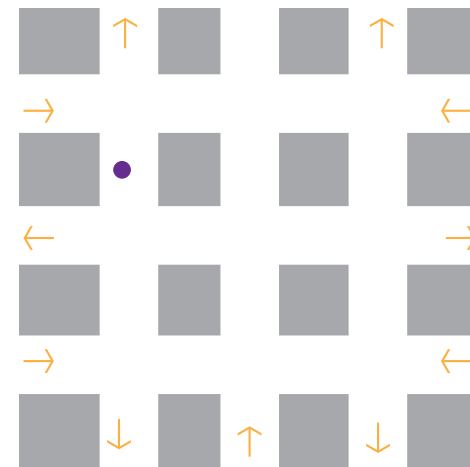

Traffic flow conversion\*

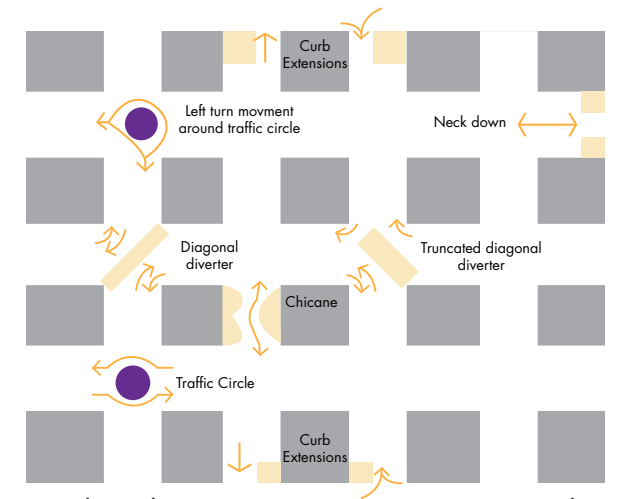

Combined countermeasure strategy example (a)

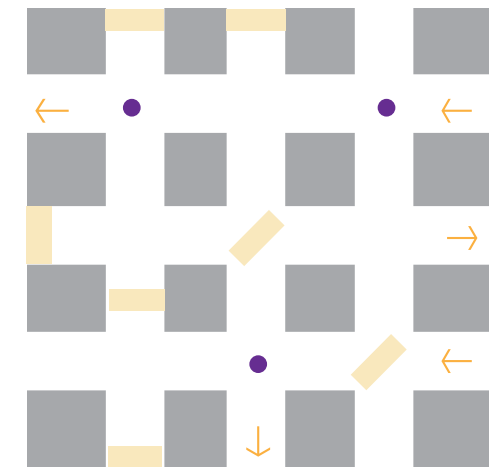

Combined countermeasure strategy example\*(b)

**TRAFFIC FLOW CONVERSION**

Another countermeasure in the toolkit is the traffic flow conversion of two-way streets to one-way streets. This strategy may benefit the overall multimodal network by providing extra space in the existing ROW to implement protected bicycle facilities, and reducing the cut through traffic in certain areas.

**PUTTING IT ALL TOGETHER**

A thorough evaluation of the street network may yield a variety of ways to create the best street calming scenario. Physical countermeasures like bike lanes, neighborhood circles, and normative countermeasures like temporary closures, or parking can achieve a network flow that is steady and can support a healthy multimodal network in the long term.

Fig 2.85 Traffic calming countermeasures at neighborhood scale.

\*Adapted from Sanz, 1998

**ON STREET PARKING AS TRAFFIC CALMING**

Motor vehicle parking is an important factor for business, although more and more people are traveling and shopping by bicycle, the availability of convenient parking influences business owners and shoppers alike.

Motor-vehicle parking is the quintessential friend and foe of design. Reducing car parking to meet the actual demand of businesses is an important and necessary step towards true multimodal redesign. However, thinking about parking as a traffic calming solution mitigates the friction that might occur among stakeholders while serving various purposes simultaneously.

On street parking is easily implemented traffic calming method that benefits commercial corridors as well as pedestrians and bicyclists. It is important to keep all users in mind when designing for motor vehicles:

1. Angled parking should be Back angled parking to facilitate visibility of bicyclists.
  - Changes the perception and function of a street.
  - Drivers pulling out must be aware of oncoming traffic
  - Oncoming drivers must be aware of cars pulling out
  - Can add up to 40% more parking capacity than parallel parking.

2. Parallel parking should be placed on the outer side of a bicycle facility in order to provide buffer between traffic and the bicycle facility  
Parallel parking stall widths should be a maximum of 8 feet depending on the adjacent uses.
3. Buffers of to avoid door collisions with bicyclists should always be provided.



Credit: Gonzalo Camacho, Kansas City Better Block.



Credit: www.peopleforbikes.org

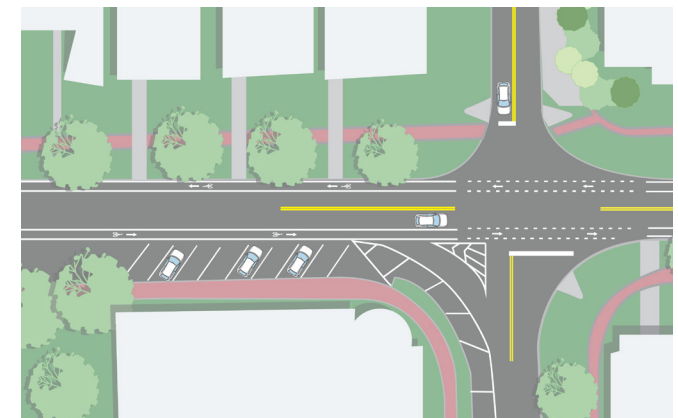

Fig 2.86 Reverse angle parking. Proposed condition for 51st street @ Cherokee Avenue in Miami Beach.

# PEDESTRIAN/ BICYCLIST/ DRIVER : COUNTERMEASUREMATRIX

STREET TYPES + COUNTERMEASURES

| STREET TYPES                   | LOCAL STREET | MAIN STREET | BOULEVARD | TRANSIT BOULEVARD | AVENUE | PEDESTRIAN STREET | SHARED SPACE | NEIGHBORHOOD GREENWAY |
|--------------------------------|--------------|-------------|-----------|-------------------|--------|-------------------|--------------|-----------------------|
| WIDE SIDEWALKS 6' MIN.         | ●            | ●           | ●         | ●                 | ●      |                   |              | ●                     |
| WIDE SIDEWALKS 6'- 10'         |              | ●           | ●         | ●                 |        |                   |              |                       |
| ALIGN CROSSWALK & RAMP         | ●            | ●           | ●         | ●                 | ●      | ●                 | ●            | ●                     |
| MID-BLOCK CROSSING             | ●            | ●           | ●         | ●                 | ●      | ●                 |              | ●                     |
| HYBRID BEACON ( HAWK)          |              |             |           |                   |        |                   |              | ●                     |
| BRAILLE/ VOICE PED CROSSING    | ●            | ●           | ●         | ●                 | ●      | ●                 | ●            | ●                     |
| CURB EXTENSION                 | ●            | ●           | ●         | ●                 | ●      |                   |              | ●                     |
| MEDIAN                         |              | ●           | ●         | ●                 | ●      |                   |              | ●                     |
| IMPROVED LIGHTING              | ●            | ●           | ●         | ●                 | ●      | ●                 | ●            | ●                     |
| CHICANES                       | ●            | ●           |           |                   | ●      |                   |              | ●                     |
| STRIPING/ DOUBLE TURN LANE     | ●            | ●           | ●         | ●                 | ●      |                   |              | ●                     |
| FRONTAGE LANE                  |              |             | ●         | ●                 |        |                   |              |                       |
| ON-STREET PARKING              | ●            | ●           | ●         | ●                 | ●      |                   | ●            | ●                     |
| DRIVEWAY MANAGEMENT            | ●            | ●           | ●         | ●                 | ●      |                   |              | ●                     |
| NO RIGHT ON RED (BIKES OK)     | ●            | ●           | ●         | ●                 | ●      | ●                 | ●            | ●                     |
| SHARED LANE MARKINGS (SHARROW) | ●            | ●           | ●         | ●                 | ●      |                   |              | ●                     |
| DIVERTER                       | ●            | ●           |           |                   | ●      |                   |              | ●                     |
| CONVENTIONAL BICYCLE LANE      | ●            | ●           | ●         |                   |        |                   | ●            |                       |
| PROTECTED BICYCLE LANE         | ●            | ●           | ●         | ●                 | ●      | ●                 | ●            | ●                     |
| SHARED USE PATH                |              | ●           | ●         |                   |        |                   |              | ●                     |
| GREEN PAINT ON BIKE FACILITY   | ●            | ●           | ●         | ●                 | ●      |                   |              |                       |
| BIKE BOX AT INTERSECTION       | ●            | ●           | ●         | ●                 | ●      | ●                 | ●            | ●                     |
| STREET TREES / TREE CANOPY     | ●            | ●           | ●         | ●                 | ●      | ●                 | ●            | ●                     |
| TRAFFIC CIRCLE                 | ●            |             |           |                   | ●      |                   | ●            | ●                     |
| BACK ANGLE PARKING             |              | ●           | ●         |                   | ●      |                   |              | ●                     |
| SPEED CUSHION                  | ●            |             |           |                   |        |                   | ●            | ●                     |
| GATEWAYS                       | ●            | ●           | ●         | ●                 | ●      | ●                 | ●            | ●                     |
| BIOSWALE                       | ●            | ●           | ●         | ●                 | ●      | ●                 | ●            | ●                     |

● Required      ● Suggested

Fig 2.87 Street types and countermeasures matrix



## **SPECIAL CONDITIONS**

The success of street design can be gaged by the efficiency and inclusivity of all users in the public realm. Intersections and other special zones present a higher possibility of conflict among users. In places where space is limited, specially in transit-oriented corridors, bicycling and pedestrian conflicts must be minimized without restricting routes or pedestrian comfort.



## PEDESTRIAN/BICYCLIST/ DRIVER : DRIVEWAY CONDITION

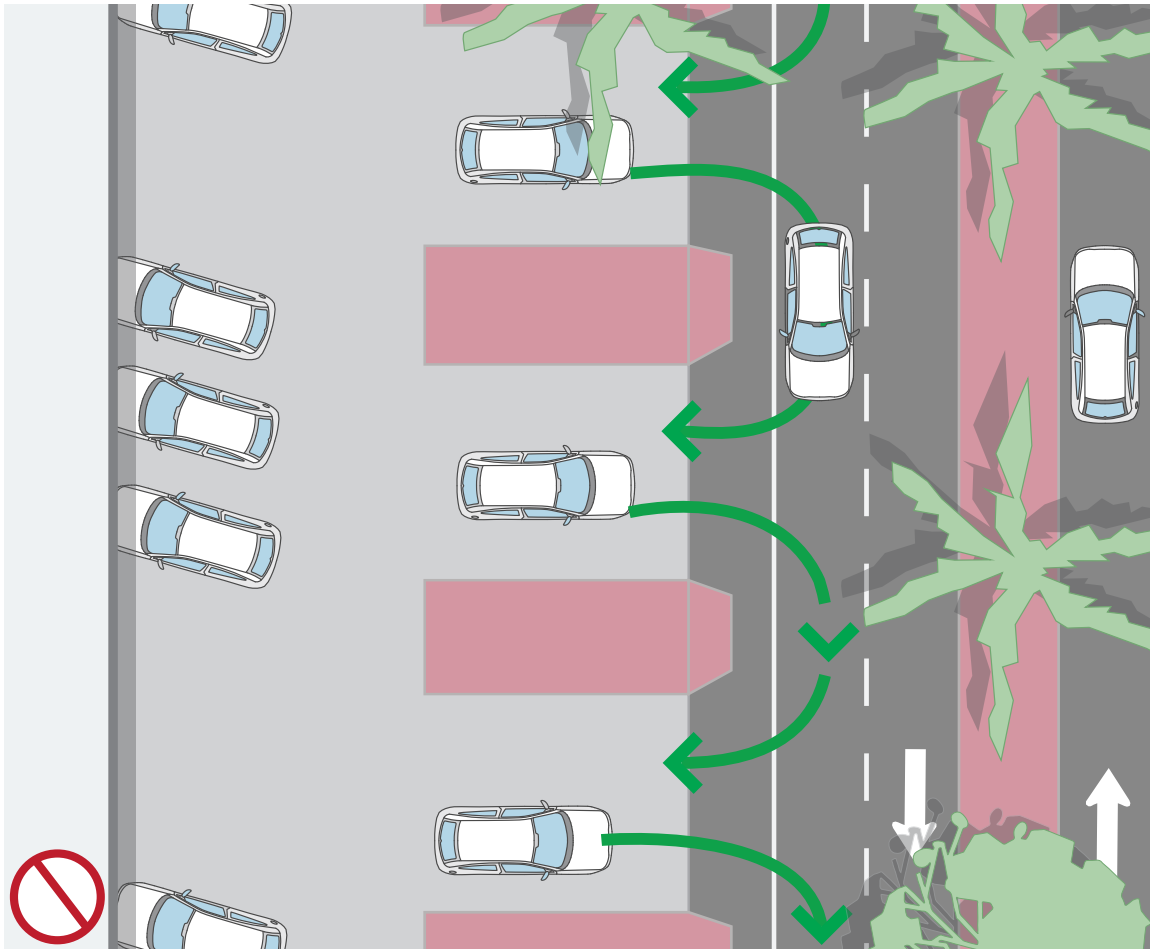

Fig 2.89 Undesirable driveway condition.

Vehicular access management through consolidating driveways and providing raised medians positively impacts the pedestrian and bicyclist experience:

- Pedestrian crossing opportunities are enhanced.
- Universal access for pedestrians is easier, since the sidewalk is less frequently interrupted by driveway slopes.
- Fewer driveways result in more space available for higher and better uses.
- Improved traffic flow may reduce the need for road widening, allowing part of the right-of-way to be recaptured for other users.

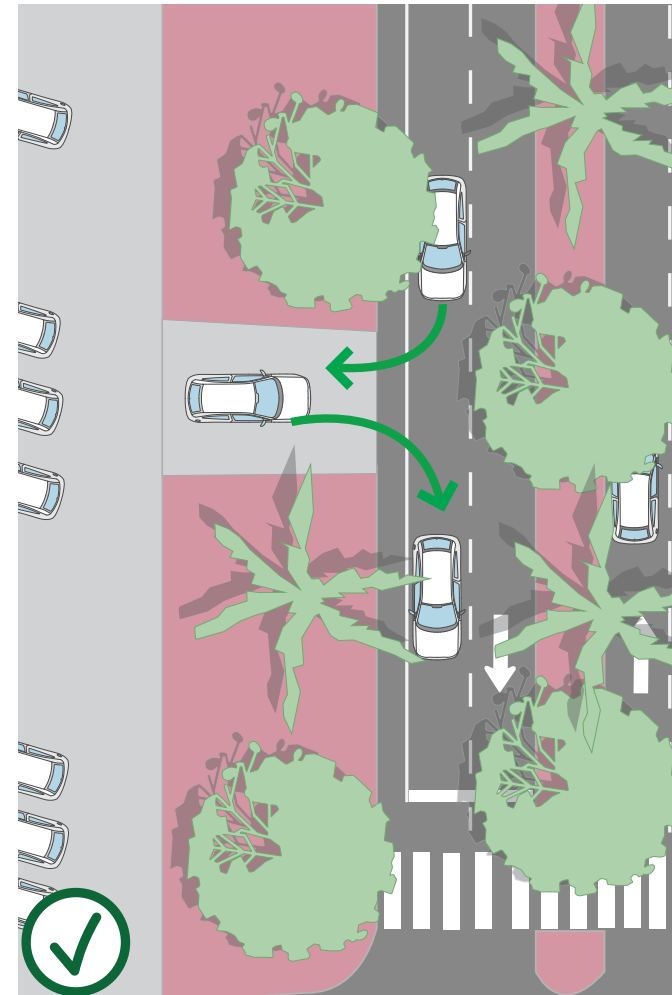

Fig 2.90 Consolidated (desirable) driveway condition.

- Consolidating driveway access is desirable where possible to minimize the number of conflict points among users.

### DRIVEWAY CONSIDERATIONS

- Driveways shall be designed to ensure pedestrians have right-of-way over motor vehicles.
- Driveways shall be designed as ramps not as minor intersections.
- Vehicle access shall be controlled through the use of yield signs.



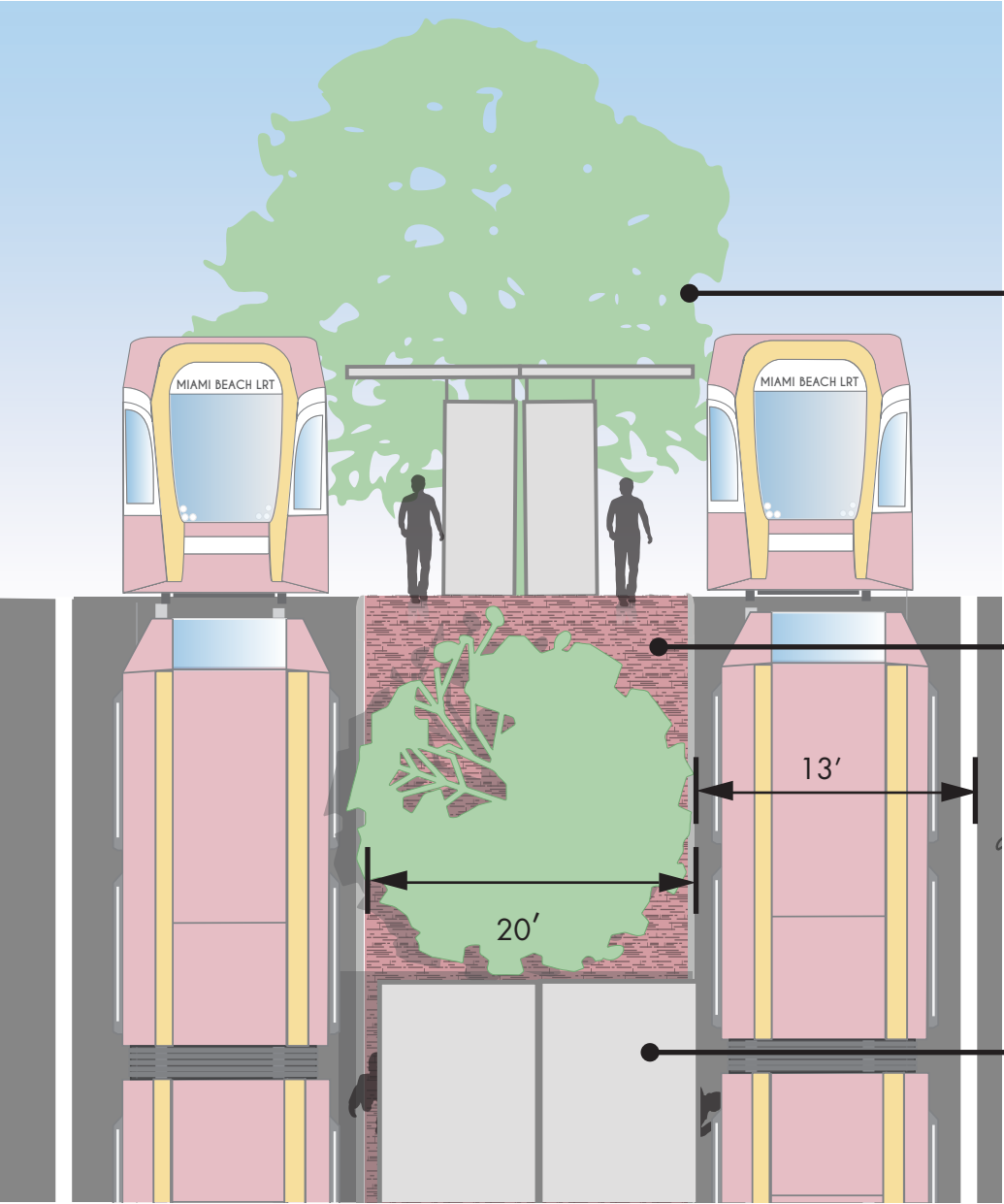

Street trees and /or shade structures are encouraged to make the transit rider experience comfortable.

Center platforms can vary in size with a preferred minimum of 20 feet. (Includes buffer) Unidirectional platforms may vary with a preferred minimum of 10 feet ( includes buffer)

Transit Shelters should be comfortable and large enough to hold the appropriate number of queuing passengers according to the expected number of riders and surrounding land use. They should also accommodate protected bicycle parking. [Please refer to the street scape section for examples of transit shelters]

A Light Rail system is very similar to a trolley or a streetcar. The term Light Rail was coined in the 1960's due to the fact that Trolleys had a negative connotation. LRT's are electric railway systems characterized by their ability to operate single or multiple car consists along exclusive rights-of-way at ground level, on aerial structures, in subways or in streets, able to board and discharge passengers at station platforms or at street, track, or car-floor level and normally (but not necessarily) powered by overhead electrical wires.

Fig 2.91 LRT/ BRT transit center platform condition.

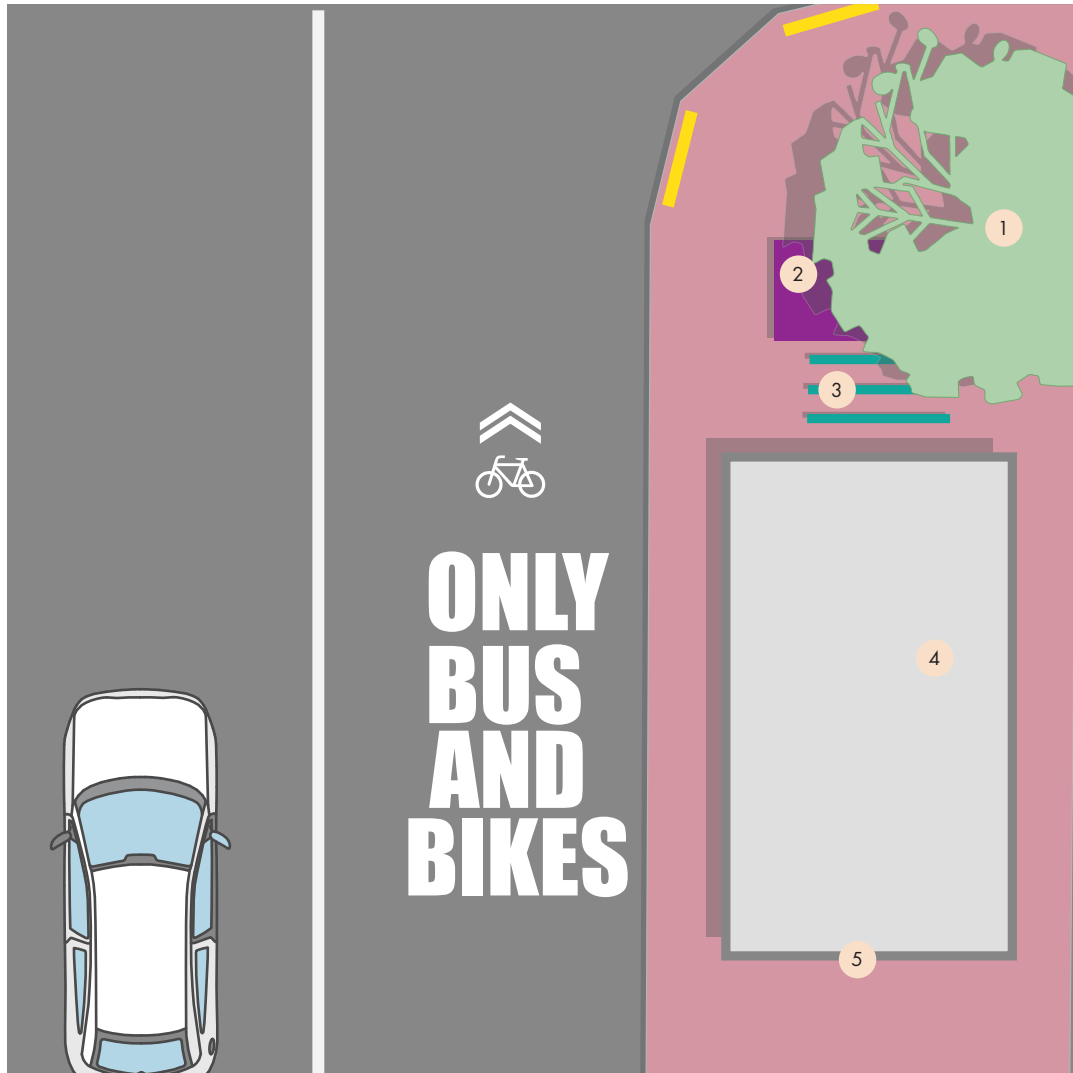

Fig 2.92 Transit stop standards, plan view.

Mixed use development and multi-use parking structures in close proximity to transit hubs are encouraged and necessary for the success of Transit Oriented Development.

Park and ride gives transit access to those users who might not live close enough to walk or have mobility impairments while still supporting the T.O.D system

- 1 Street trees and /or shade structures are encouraged to make the pedestrian and transit rider experience comfortable.
- 2 Bicycle lockers should be provided at large / most active transit hubs to encourage bike and ride combinations of transit. Integrating bicycle parking with transit stops, encourages transit ridership as well as bicycling.
- 3 Bicycle parking should be oriented in a way that maximizes space and does not protrude on to the pedestrian through zone
- 4 Transit Shelters should be comfortable and large enough to hold the appropriate number of queuing passengers according to the expected number of riders and surrounding land use
- 5 Maps, diagrams and graphic directories of the surrounding area shall be clearly provided. In addition, bicycle route maps shall be provided.
- 6 Shelter bicycle parking can be a stand alone facility or function in combination with transit stops.



Fig 2.93 Shelter bicycle parking example.

## PEDESTRIAN/BICYCLIST/MOTOR VEHICLE: TRANSIT STOP AND SIDEWALK LEVEL BIKE LANE (A)

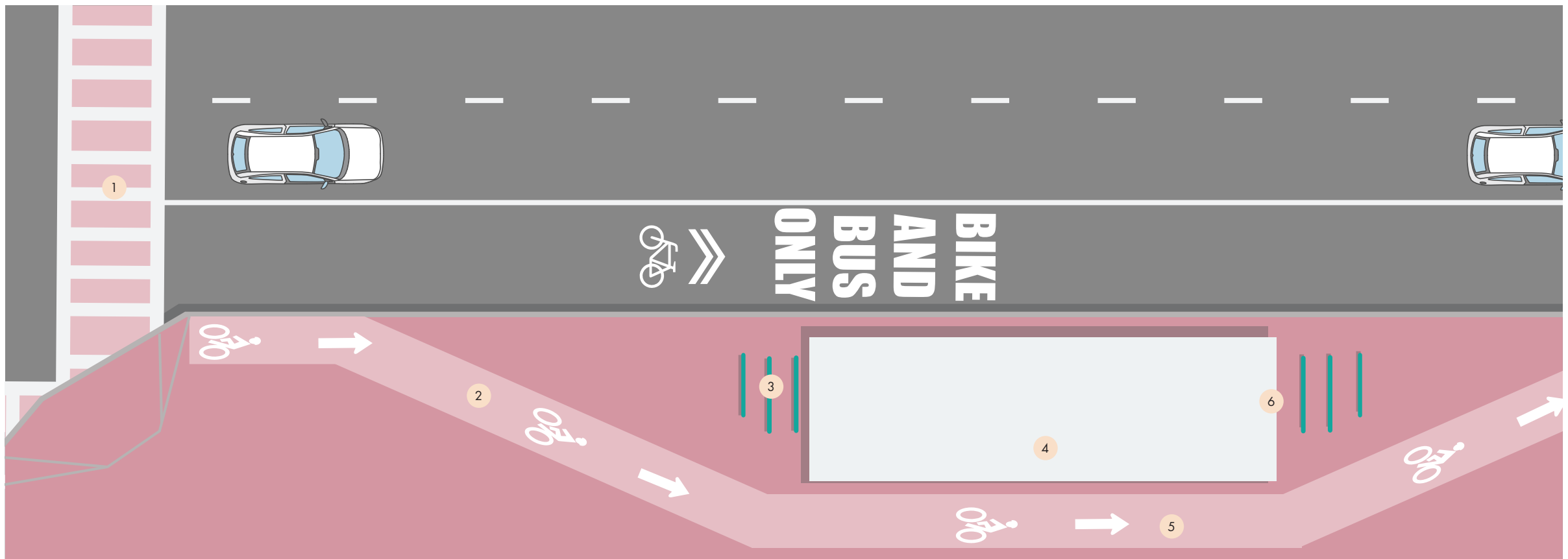

Fig 2.94 Sidewalk- level protected bicycle lane at transit stop (a).

- 1 Painted sidewalks enhance the aesthetic appeal of pedestrian realm while effectively providing high visibility for bicyclists and motor vehicles and improving safety at crossings.
- 2 Protected bicycle lanes at sidewalk level can be painted in a lighter shade of pink in order to provide a visual path for people on bicycle without disrupting the visual coherence of the sidewalk.
- 3 Bicycle parking should be located close to transit shelter. Parking should be oriented in a way that does not obstruct pedestrian through zone. If possible, bicycle parking should be sheltered.
- 4 Transit shelters should be placed close to the street and be sheltered. Where possible, street trees and landscaping shall be planted for shelter and storm water management (rain gardens, bioswales).
- 5 If protected bike lane cannot be shifted to the street or continue on the street side, path must be moved to the back of the transit stop to provide uninterrupted movement to bicyclists.
- 6 Transit shelters shall provide transit maps as well as bicycle maps that are easy to understand by the multicultural population of Miami Beach.

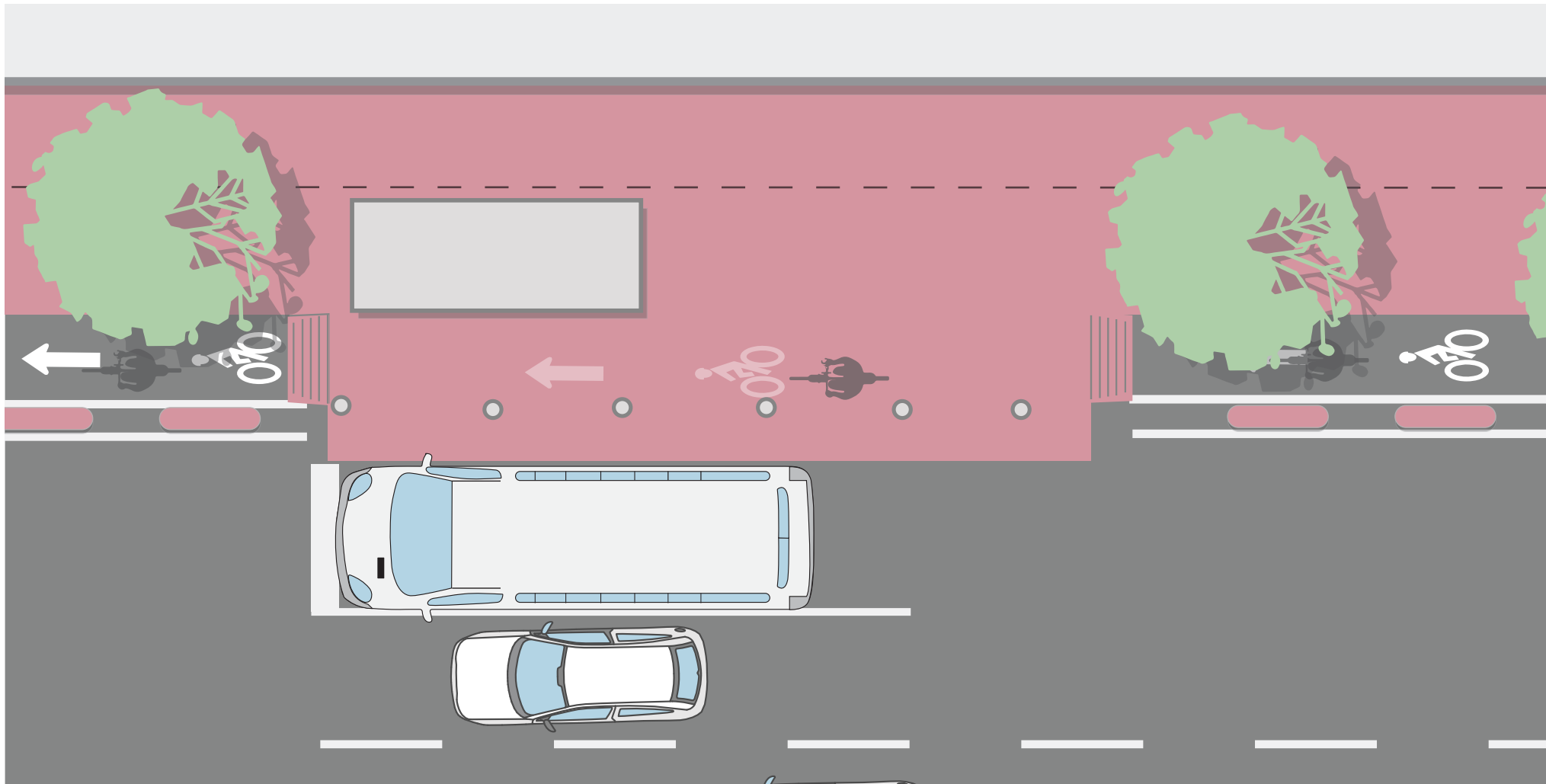

Fig 2.95 Sidewalk-level protected bicycle lane at transit stop (b).

In this design, the transit stop remains in its original location. However the Transit platform extends onto the protected bicycle lane creating a temporary sidewalk-level protected bike lane condition. Bikes follow a direct route in front of the transit shelter while yielding to pedestrians upon pick-up and drop-off. The transit rider queuing area is separated from the bicycle lane by bollards, planters or any other street furnishing/landscape elements appropriate depending on space constraints.

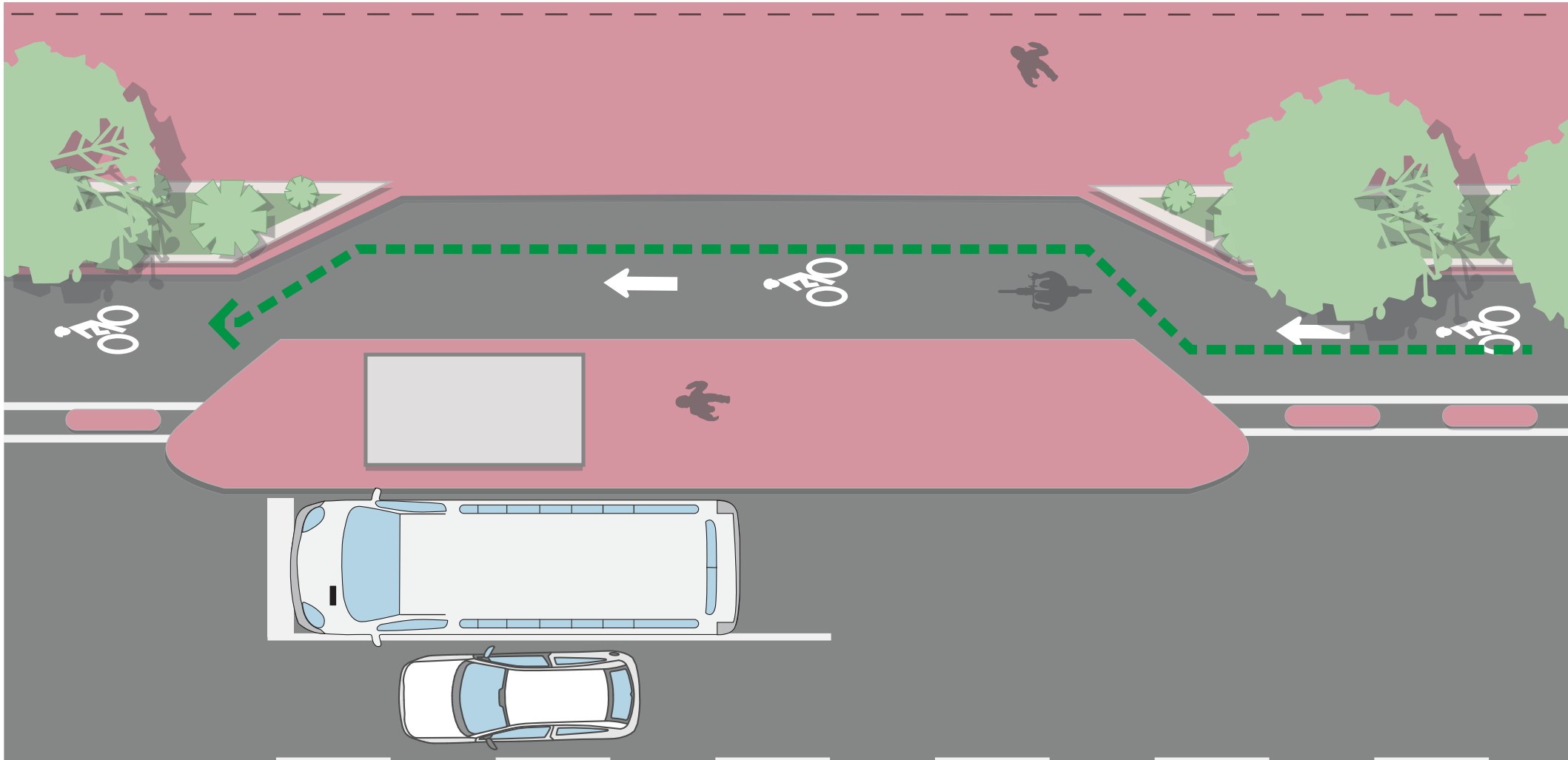

Fig 2.96 Sidewalk-level protected bicycle lane at transit stop (c).

In this design, the transit stop is located on the outside of the protected bicycle lane. Bicyclists yield to pedestrians at crossing. Passenger pick-up and drop-off is carried out on the travel lane.

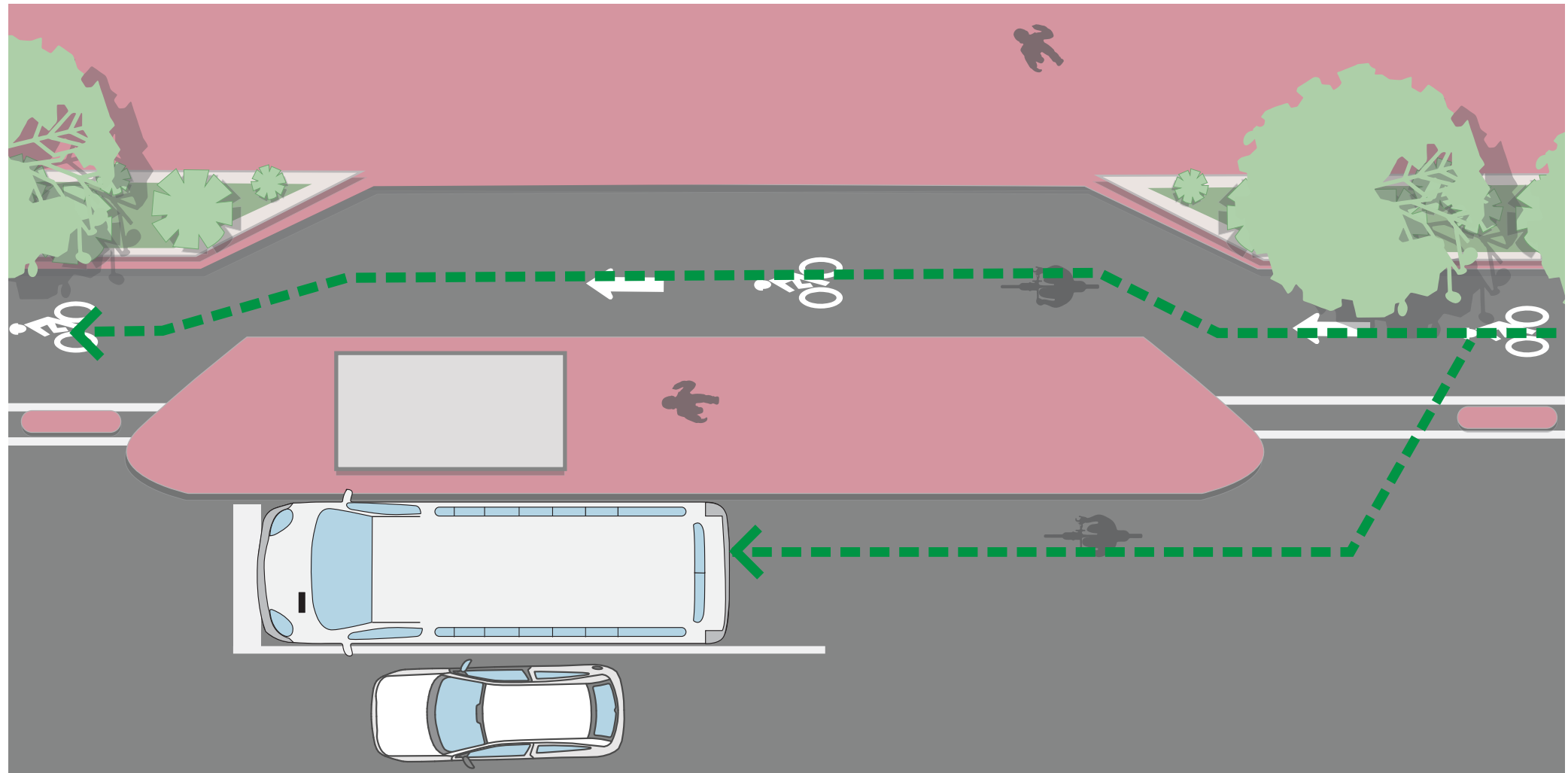

Fig 2.97 Sidewalk-level protected bicycle lane at transit stop (d).

This configuration allows bicyclists to operate behind the transit stop in the dedicated bicycle lane during drop-off and pick-up of passengers. However, If there is no bus, bicyclists may use the transit lane if necessary.



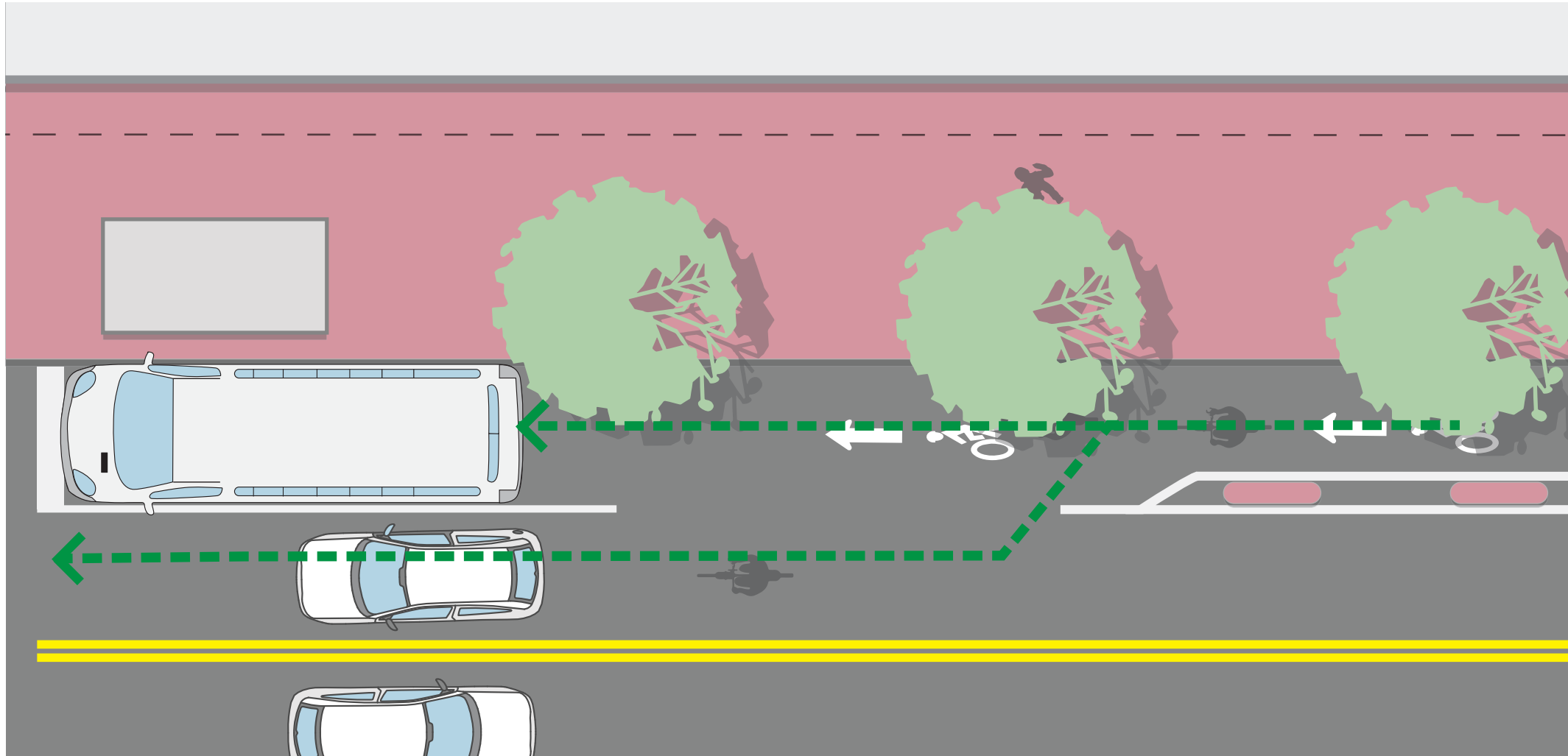
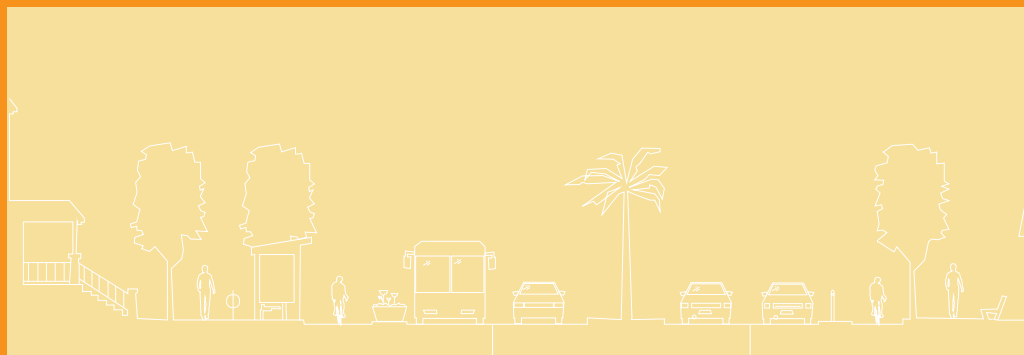

Fig 2.98 Sidewalk- level protected bicycle lane at transit stop (e).

For this solution, the intersection approach is shared between the transit and bicyclist. This means that the protected bicycle lane condition is interrupted at a crucial point of convergence which is highly inadvisable. In addition to being unprotected, bicyclists are usually forced to queue behind transit vehicles during drop off and pick-up times, in which case bicyclists lose momentum and breathe in larger than normal amounts of exhaust fumes unnecessarily. However, this can be avoided if the transit bay is widened to accommodate a wide enough passing zone for bicyclist along with a bike box at the intersection, thus given priority to bicyclist at the intersection approach to improve visibility, health, and maintain bicyclists momentum.





## STREETSCAPE

The streetscape is the sum of all the elements that make up the public realm both functionally and aesthetically. The Streetscape encompasses building materials, street furnishings, landscaping and lighting elements; along with parklets and bicycle parking. Successful streetscapes present the following elements:

- Inclusive/ Universal design for all users regardless of age or visual/mobility impairments
- Dedicated amenities for all users.
- Pedestrian-oriented.
- Ample public seating and landscaping.
- Shade in the form of street trees or shade structures and /or trellises.
- Aesthetic elements incorporated through patterns on sidewalks/ public art/ seating / landscaping.
- Human-scale lighting.
- Easy to understand signage .
- Conveys The City's brand.



**PORTUGUESE PAVING**

Traditional paving style used for pedestrian areas in Portugal. Currently used on the west end of Lincoln Road.

- Presents certain hazards to people with physical impairments.
- Reduced longevity in comparison to other materials.
- Slippery when wet.



**MODULAR CURB**

Modular curbs are one of the alternatives to implement a segregated bike facility in a time-effective manner.

- Separate bicyclist from motor vehicles in ROW.
- Durable
- Easy installation



**MODULAR COBBLESTONE**

Transforms the character of roadways from vehicle oriented to pedestrian/bicyclist oriented.

- Smooth surface unlike traditional cobble stone, is unlikely to hinder mobility for people using mobility aids.
- If necessary, adapt a “reduced vibration zone” that accommodates people with mobility impairments.
- Consider use on streets not intended for regular vehicle travel.
- Should not be used in areas where frequent utility cuts are likely.
- Various colors and designs available.



**POROUS ASPHALT**

- Allows storm water to drain through, reducing runoff into the sewer system.
- Not appropriate for use where there is water-sensitive subsurface infrastructure.
- Only certain surfaces are appropriate as sub bases for infiltration.
- May require routine street cleaning to maintain porosity.
- Installation of this type of pavement should go in hand with chemicals/vehicle standards to avoid infiltration of harmful chemicals into the watershed and ocean.
- Can be used to pave entire roadways, or just parking lots, and gutters.



**CONCRETE**

Cement aggregates, water and other chemical mixtures poured over metal reinforcement bars which is then smoothed, forming a solid road surface.

- Easily available and cost effective.
- Used where engineering criteria dictates, ie. bridges, vaulted roads or bus pads.



**IMPRINTED ASPHALT**

Machine - heated asphalt, imprinted with a pattern and colored with protective coating.

- Can be installed on existing asphalt in good condition.
- visually defines pedestrian or non-vehicle areas.
- Good for shared spaces and pedestrian streets.



**TINTED CONCRETE**

Same mixture as concrete with an added pigment.

- Signature of most Miami Beach sidewalks.
- Gives emphasis to the pedestrian zone.
- Sparkle adds distinction and visual enhancement.



**INTERLOCKING PAVINGS**

Interlocking pavings allow for vegetation to grow in between units, providing a hard surface while allowing for infiltration.

- Can be made of asphalt or concrete.





**VERTICAL LANDSCAPING**

- Vertical landscaping can serve to separate furnishing zones from pedestrian through zones, as landmarks or to add greenery and character to a specific zone.
- Living walls mitigate the heat island effect while decorating long stretches of otherwise plain frontage

**TRELLIS & SHADE**

- Trellises can act as small gateways as well as shade structures .
- Walkways should incorporate attached or detached shade structures rather than individual kiosk umbrellas for aesthetic purposes.

**BIOSWALES & STORM WATER MANAGEMENT**

- Swaled drainage course with gently sloped sides (less than six percent)
- Filled with vegetation, compost and/or riprap.
- Add greenery to the streetscape while providing ecosystem services.

Fig 3.1 Bioswale cross section.

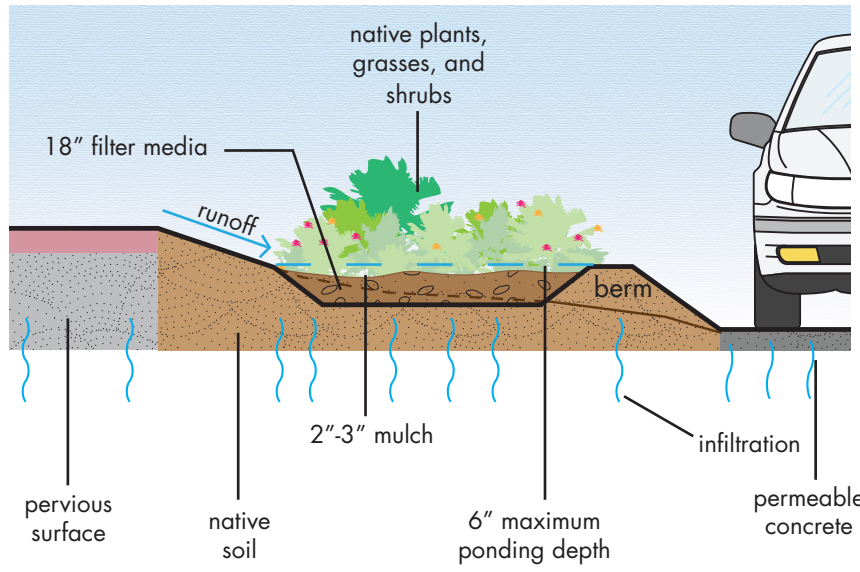

Bioswales, rain gardens, bioretention curbs, permeable concrete and other materials/ treatments that aid to slow down and filtrate storm water runoff, should be considered and implemented in all street design projects. In addition, policy could be developed around the implementation of rain gardens in private properties to develop a resilient and robust environmentally sensitive landscaping program for Miami Beach residents.







### STREET BANNERS AND HANGING PLANTS

- Banners offer opportunity for branding and way finding.
- Metal banners are durable and can have a large variety of designs.
- Hanging plants give aesthetic value to streetscapes. Use climate appropriate plants.



### PLANTERS AND SEATING

- Planters can incorporate public seating.
- Provide resting areas at regular intervals for pedestrians.
- Should never encroach on pedestrian through zone.



### REST AIDS

Parklets can be installed for additional seating and gathering spaces. Large bollards can act as an informal resting spaces while providing a barrier from the motorized travel way.



### SHADE STRUCTURES

- Shade sculptures provide much needed shade and can act as trellises.
- Custom designed shade structures give character to the streetscape.
- Shade structures are also crucial as refuge from the heavy rains in the summer months.

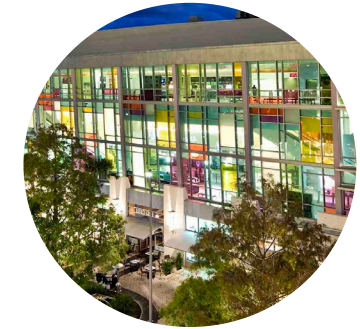

### LANDSCAPE PLAZAS AND STREET TREES

- Large public gathering spaces should incorporate large vegetation and water elements when possible.
- Well maintained landscaped areas in Miami Beach have become meaningful “third-places” and successful gathering areas.







**OVERHEAD PEDESTRIAN LIGHTING**

Human-scale lighting directly influences the quality of the public realm. Large flood lights ,although appropriate for highways and large open spaces, change the perception of the public realm. Street lighting should be thought of not only as a safety measure but an aesthetic measure. Street lighting should be implemented according to scale



**LIGHT BOLLARDS**

Light bollards serve to illuminate paths and can serve as accents where extensive tree canopy may prevent light from reaching the ground. Light bollards are as functional as they are decorative. The bottom photo shows how patterns on the lamp display an ornate shadow on the ground when lit. All lighting, including bollards can be powered through solar technology.



**ALLEY & PEDESTRIAN BRIDGE LIGHTING**

Pedestrian bridges and alley ways present an opportunity for pedestrian connectivity. Making sure that these areas are well lit is crucial for their intended purpose to be fulfilled. Pedestrians are particularly vulnerable in poor-lit areas which limits pedestrian activity in the public realm.



**LIGHT TREES**

These type of structures serve as rest areas for pedestrians and bicyclists through the public seating provided below. Above, the "light tree" harvests solar energy during the day providing light at night.

Note:  
Lights along the coastal pathways should be approved by Florida Fish and Wildlife Conservation Commission. The City is using Tri-ada bollard with amber LED lights at this time.



**WASTE RECEPTACLES**

Appropriate waste disposal is crucial to an enjoyable public space. Providing adequate receptacles in accordance to streetscape design helps maintain spaces clean and free of unwanted pests. Waste receptacles should be located at regular intervals, alongside bus stops and gathering spaces

# PUBLIC FRONTAGE ASSEMBLY











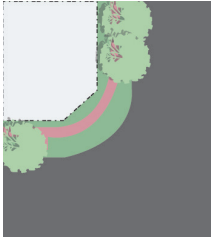

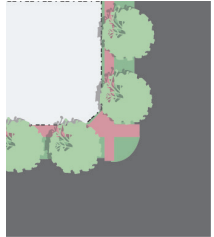
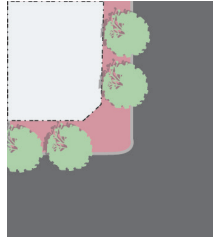
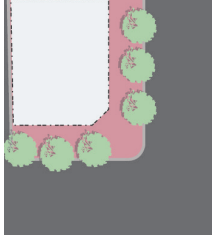

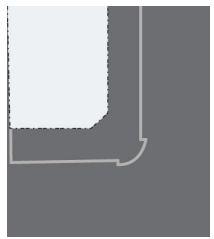
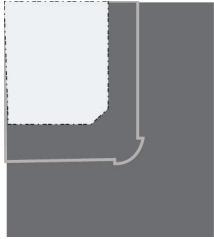

| STREET TYPE  | NEIGHBORHOOD STREET SUBURBAN  | NEIGHBORHOOD STREET SUBURBAN  | NEIGHBORHOOD STREET SUBURBAN  | BOULEVARD  | BOULEVARD- SUBURBAN AVENUE  | NEIGHBORHOOD STREET URBAN - BOULEVARD- MAIN STREET- URBAN AVENUE  |
|--|---|---|---|--|---|---|
| <p><b>A. ASSEMBLY:</b><br/>The principle variables are the type and dimension of curbs, walkways, planters and landscapes.</p> <p>TOTAL WIDTH</p>                              | <br>16 - 24 FEET   | <br>12 - 24 FEET   | <br>12 - 18 FEET   | <br>12 - 18 FEET  | <br>12 - 20 FEET   | <br>12 - 24 FEET   |
| <p><b>B. CURB:</b><br/>The detailing of the edge of vehicular pavement, incorporating drainage.</p> <p>TYPE<br/>RADIUS</p>   | <br>OPEN SWALE<br>10- 30 FEET                              | <br>OPEN SWALE<br>10- 30 FEET                              | <br>RAISED CURB<br>5 - 20 FEET                                 | <br>RAISED CURB<br>5 - 20 FEET                            | <br>RAISED CURB<br>5 - 20 FEET                           | <br>RAISED CURB<br>5 - 20 FEET                           |
| <p><b>C. WALKWAY:</b><br/>The portion of the thoroughfare dedicated exclusively to pedestrian activity.</p> <p>TYPE<br/>WIDTH</p>  | <br>PATH OPTIONAL<br>N/A                                  | <br>PATH<br>4 - 8 FEET                                    | <br>SIDEWALK<br>4 - 8 FEET                                    | <br>SIDEWALK<br>4 - 8 FEET                               | <br>SIDEWALK<br>8 - 12 FEET                             | <br>SIDEWALK<br>10 - 20 FEET                            |
| <p><b>D. PLANTER:</b><br/>The portion of the thoroughfare accommodating street trees and other landscape</p> <p>ARRANGEMENT<br/>SPECIES<br/>PLANTER TYPE<br/>PLANTER WIDTH</p> | <br>CLUSTERED<br>CLUSTERED<br>CONT. SWALE<br>8 - 18 FEET | <br>CLUSTERED<br>CLUSTERED<br>CONT. SWALE<br>8 - 16 FEET | <br>REGULAR<br>ALTERNATING<br>CONT. PLANTER<br>8.5 - 12 FEET | <br>REGULAR<br>SINGLE<br>CONT. PLANTER<br>8.5 - 12 FEET | <br>REGULAR<br>SINGLE<br>CONT. PLANTER<br>8.5 - 9 FEET | <br>OPPORTUNISTIC<br>SINGLE<br>TREE WELL<br>4 - 9 FEET |

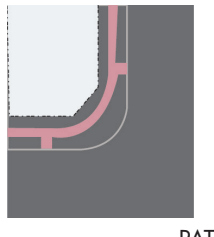
Fig 3.2 Public Frontage Assembly Matrix.

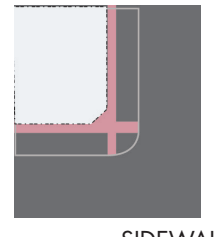
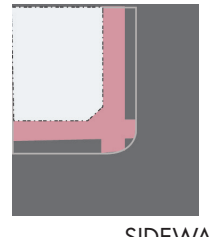
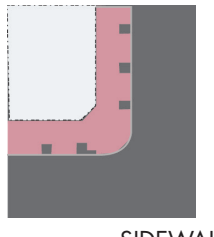

1. Common Yard: A planted Frontage wherein the Facade is set back substantially from the Frontage Line. The front yard created remains unfenced and is visually continuous with adjacent yards, supporting a common landscape. The deep Setback provides a buffer from the higher speed Thoroughfares.

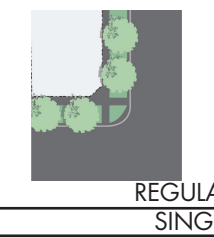

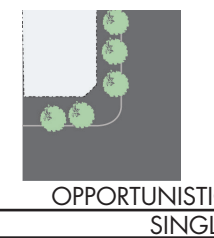
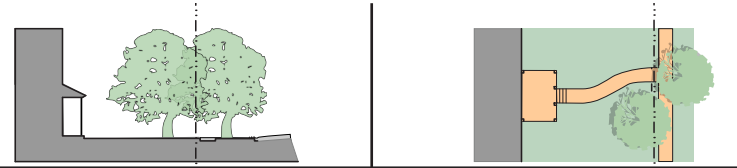
2. Porch & Fence: a planted Frontage wherein the Facade is set back from the Frontage Line with an attached porch permitted to Encroach. A fence at the Frontage Line maintains street spatial definition. Porches shall be no less than 8 feet deep.

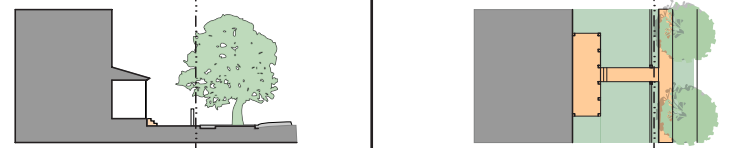

3. Terrace or Lightwell: a Frontage wherein the Facade is set back from the Frontage line by an elevated terrace or a sunken Lightwell. This type buffers Residential use from urban Sidewalks and removes the private yard from public Encroachment.



4. Forecourt: a Frontage where a portion of the Facade is close to the Frontage Line and the central portion is set back. The Forecourt created is suitable for vehicular drop-offs. Should be allocated in conjunction with other Frontage types. Large trees within the Forecourts may overhang the Sidewalks.



5. Stoop: Frontage wherein the Facade is aligned close to the Frontage Line with the first Story elevated from the Sidewalk sufficiently to secure privacy for the windows. The entrance is usually an exterior stair and landing. This type is recommended for ground-floor Residential use.



6. Shopfront: Frontage wherein the Facade is aligned close to the Frontage Line with the building entrance at Sidewalk grade. This type is conventional for Retail use. It has a substantial glazing on the Sidewalk level and an awning that may overlap the Sidewalk to within 2 feet of the Curb.



7. Gallery: Frontage wherein the Facade is aligned close to the Frontage line with an attached cantilevered shed or a lightweight colonnade overlapping the Sidewalk. Conventional for Retail use. It shall be no less than 10 feet wide and should overlap the Sidewalk to within 2' of the Curb.



8. Arcade: a colonnade supporting habitable space that overlaps the Sidewalk, while the Facade at Sidewalk level remains at or behind the Frontage Line. This type is conventional for Retail use. The Arcade shall be no less than 12 feet wide and should overlap the Sidewalk to within 2 feet of the Curb.

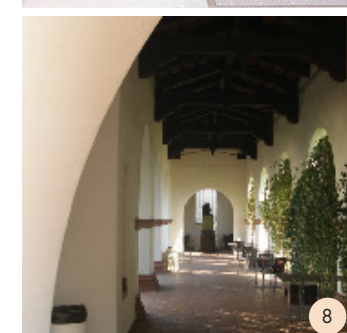
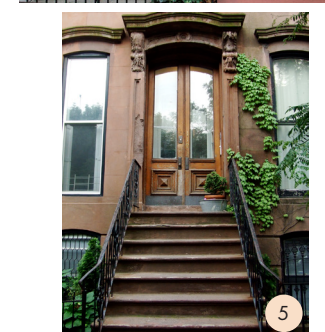
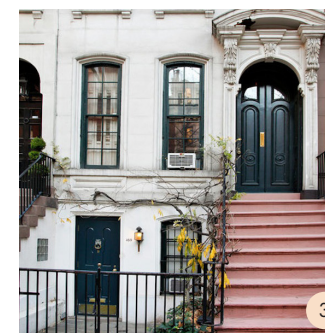
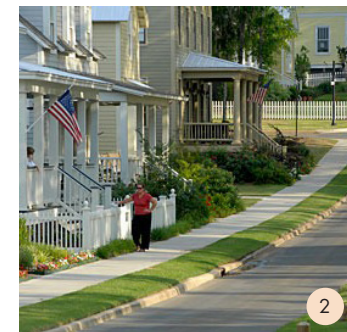
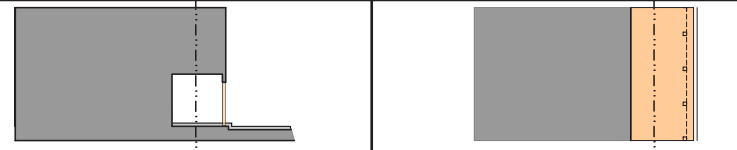

Fig 3.3 Private Frontage Assembly types

# STREET TREES: PLANTING STANDARDS

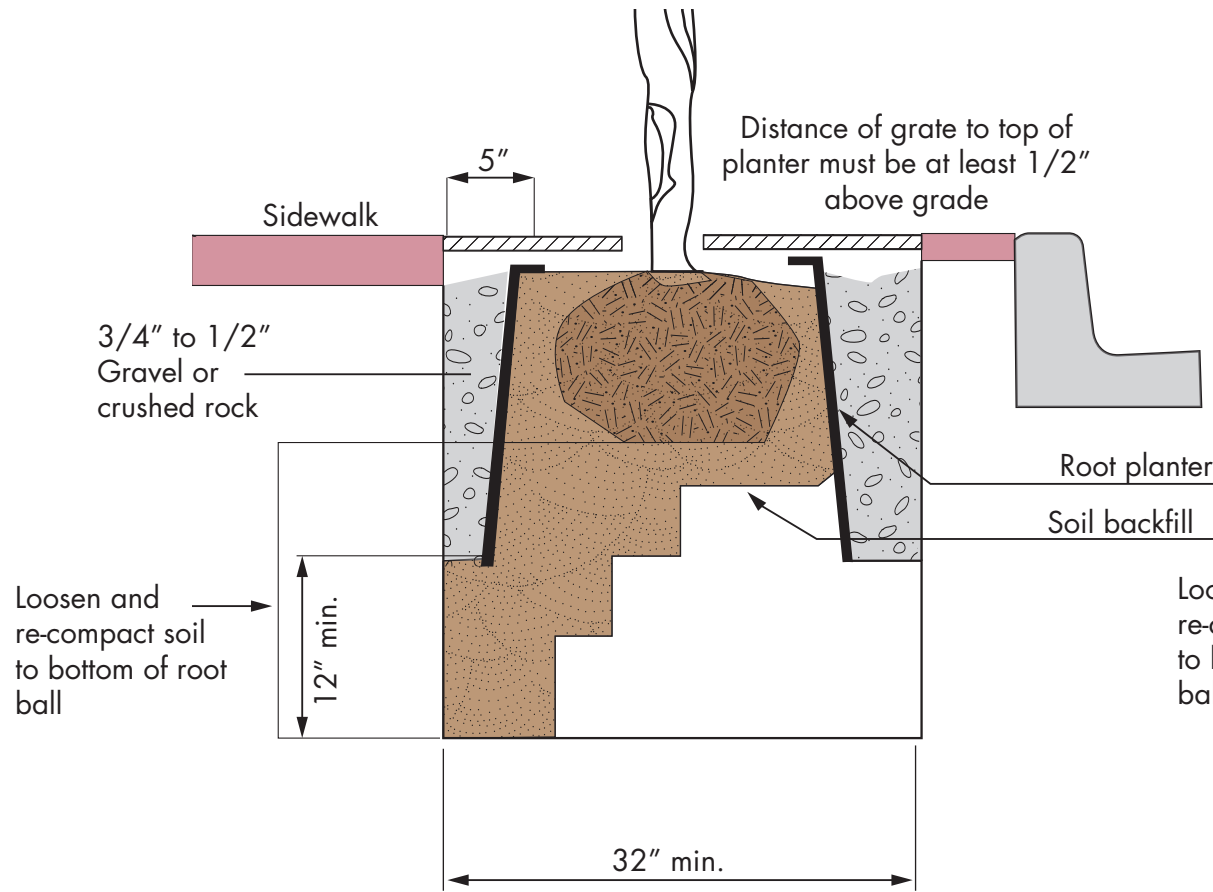

Fig 3.5 Root barrier inside grate.

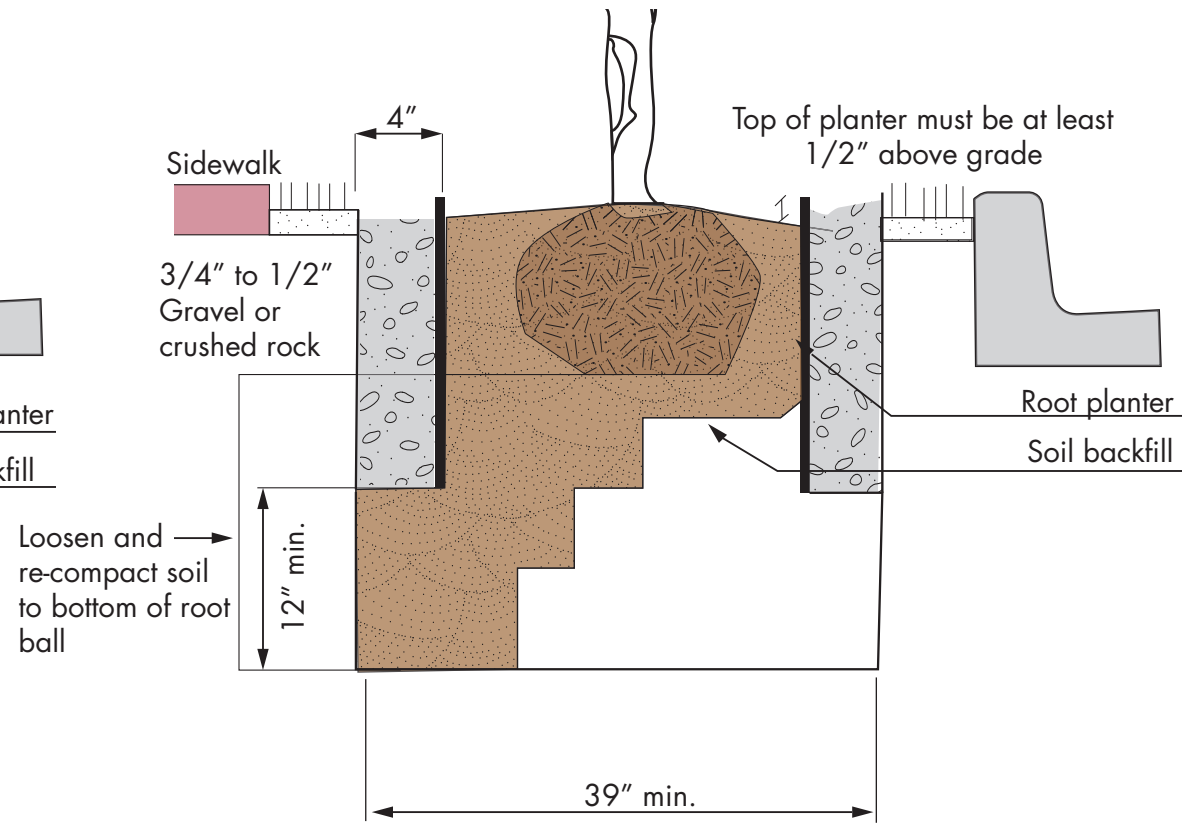

Fig 3.6 Root barrier detail.

Street trees are an integral part of a city's streetscape. They provide a variety of ecosystems services like:

- Energy savings due to the shading of buildings.
- Reduction of storm water runoff.
- Carbon dioxide sequestration

In addition to quantifiable environmental services street trees have a direct impact on the quality of life of the population, and the vibrancy of the public realm which translate into increased private real estate market values.

As mentioned above, trees provide important aesthetic and ecological benefits to City residents, yet plants in the urban landscape face a variety of environmental and physical stresses, including pedestrian and vehicular traffic, soil compaction, air pollution, and drought. Some of the key factors to maximize long-term plant survival are proper handling, careful planting, and immediate and continued aftercare.

The following general planting standards should be followed to ensure healthy tree growth and establishment.

### SPACING REQUIREMENTS

The following requirements shall be followed when siting tree pits along sidewalks. These guidelines generally follow regulations of other agencies with right-of-way jurisdictions or infrastructure present. Tree planting requirements are design and tree species dependent. However, The Americans with Disabilities Act (ADA) must be followed in all cases.

- A) Do not plant in front of a building in order to allow easy access to the building by the fire department.
- B) Do not plant directly over DEP water mains less than 20 inches in diameter.
- C) The minimum horizontal distance from DEP water main to tree trunk is 6 feet.
- D) Do not plant within bus stops.
- E) The minimum distance between trees (trunk to trunk shall be 20'-30' depending on species, assuming mature canopy size).
- F) Minimum distance from a streetlight to the tree trunk is 25 feet (may vary according tree species).
- G) The minimum distance from a stop sign to a tree trunk is 30'.
- H) The minimum distance between other traffic signs and a tree trunk is 6'.
- I) The minimum distance from a fire hydrant to the edge of a tree pit is 3'.
- J) Minimum distance from a gas or water valve to the edge of the pit is 2'.
- K) Minimum distance from a curb cut or driveway to the edge of the tree pit is 2' and to the tree trunk is 7'.
- L) Suggested distance from a parking meter back to a tree trunk shall be no more than 5', in order to allow for the swing of car doors.
- M) Minimum distance from the edge of the tree pit to any opposite obstruction (building wall, railing, property line etc) is from 4 to 6 feet, depending upon local conditions and the amount of sidewalk traffic.
- N) All tree pits must be contiguous to the street curb (except as noted below, or with the permission of the Agency representative).
- O) Trees may be planted on either side of sidewalks (if any exist) in lawn areas where there is enough room between the property line and the street curb.

### TREE PIT DIMENSIONS

Tree pits should be as large as possible to accommodate ample growing for the roots while avoiding sidewalk lifting. Optimal tree pit size is directly proportional to tree species. However, a large soil volume and ample size promote healthy growth and establishment. The minimum width of a tree pit is twice equal the tree ball diameter. Tree pit should have a slope of 2'.

### GROUP PLANTINGS

Group plantings increase shading, reduce soil compaction, have access to greater available soil volume. Continuous tree plantings are the signature planting of residential streets, medians and most boulevards. In addition, raised plantings found in plazas or along pedestrian passageways

### MAINTENANCE

- Trees should have a guarantee period for the first 2 years.
- Watering intervals shall be established according to tree species and followed closely to guarantee healthy tree establishment.
- Mulch should be applied uniformly around the tree trunk, at the time of planting and at the end of the first year (3 inch depth). A 2" diameter around the trunk shall be left free of mulch to avoid mounding.
- Pruning of dead branches and/or established canopy shall be ongoing in order to comply with maximum heights and existing facilities (powerlines etc).







## PARKLETS: ANATOMY OF A PARKLET

A Parklet is a small “park”, plaza or creative public space that is formally and permanently installed in what would usually be on-street parking.

Parklets are most commonly the length of 1 to 2 parallel parking spaces or 3- 4 angled parking spaces, however, length may vary according to design and street configuration.

Streets make up a large part of urban public space. Parklets offer many advantages to the quality of public space and the context that surrounds them. Parklets come in many shapes, and vary greatly in purpose. Specific programming and design of the parklet should be subjected to an approval process to determine the best suitable use according to location.

- 1 Parklets are allowed on streets with speed limits of 25 mph or less.
- 2 In general, Parklets must be located at least 1 parking space away from the corner. Bulb-outs and other physical barriers that protect the parklet, may allow for corner parklets.
- 3 All parklets must include 4-foot setbacks on either side to buffer the parklet from adjacent on-street parking spaces and driveways. They must include bollards or other elements of physical separation.
- 4 A 3 foot wheel stop must be placed at both ends of the parklet to prevent accidents.
- 5 ADA access must ALWAYS be included in all parklet configurations.
- 6 Parklets should attempt to include bicycle parking in all the designs.

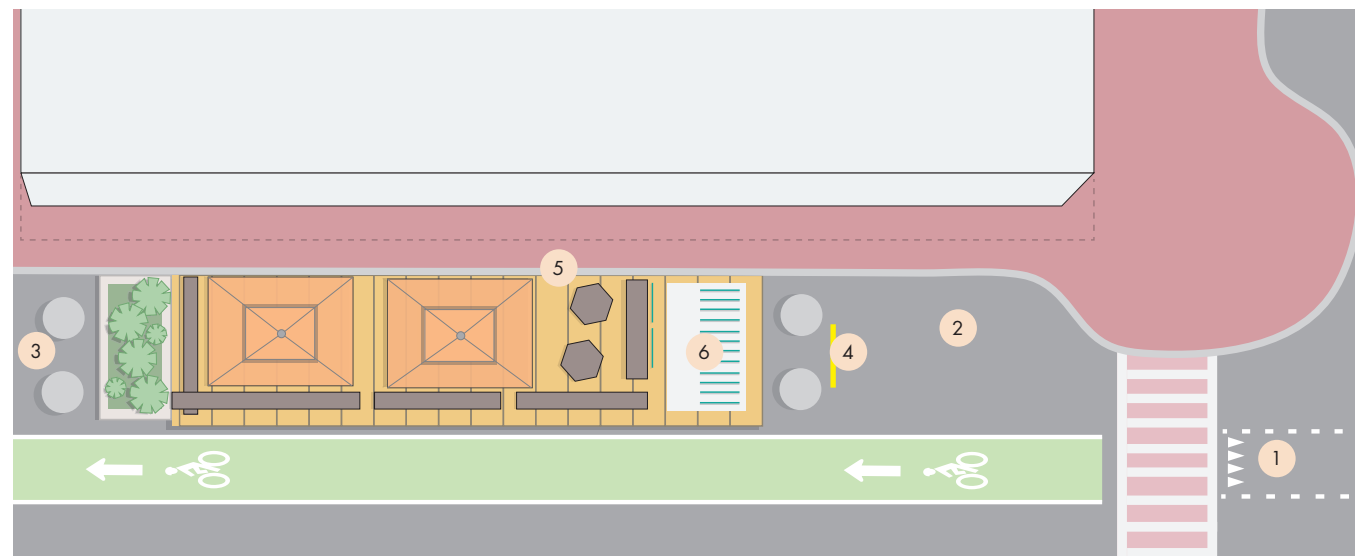

Fig 3.5 Parklet standards (a).

In addition, Parklets must comply with the following standards:

- The parklet must be installed in metered spaces only.
- Parklets may not be installed on bus lanes, in front of active driveways, fire hydrants or access points. If a parklet is located next to a driveway, the parklet must be set back 2 feet from the outer edge of the driveway.
- Parklets cannot be installed in a parking lane that becomes a travel lane at any time of the day.
- Parklets cannot be installed in close proximity to high turn over businesses like: Post offices and banks.
- The parklet should have an edge to buffer the street. This can take the form of planters, railing, cabling, or some other materials approved. Height and scale of the buffer required may vary according to local context. For example, on some low-traffic streets, a continuous edge may not be required.
- Parklets must maintain visual porosity between the sidewalk and adjacent travel lanes. Columns and other vertical elements are allowed. Elements like continuous opaque glass or vegetation may not be higher than 42"
- The space underneath the parklet must be accessible through removable pavers or planks. Parklets are platform surfaces.
- Parklets are public space.
- With standard setbacks, the dimensions of a parklet in one space (9'x20') would be 6' x 12'.

In order to guarantee high standards of safety, aesthetic compliance and accessibility, parklet proposals shall include :

1. A map with the parking location and context.
2. A detailed plan of the adjacent area including:
  - sidewalk width.
  - manholes and other access points.
  - existing metered parking spaces.
  - entrances and uses of adjacent buildings.
  - Existing utility panels, lights, bike racks, fire hydrants etc.
  - Adjacent bicycle facility or travel lane
  - Proposed parklet dimensions including setbacks.
3. A detailed section of the parklet including:
  - All elements included in the design.
  - a list of all landscaping to be included.
  - Detailed elevation.
  - Materials to be used.
4. A detailed construction drawing approved by a drawing sealed by a professional engineer/ architect that includes:
  - Hardware to be used.
  - A detailed drawing of the drainage channel as well as accessibility to the channel if it gets blocked.

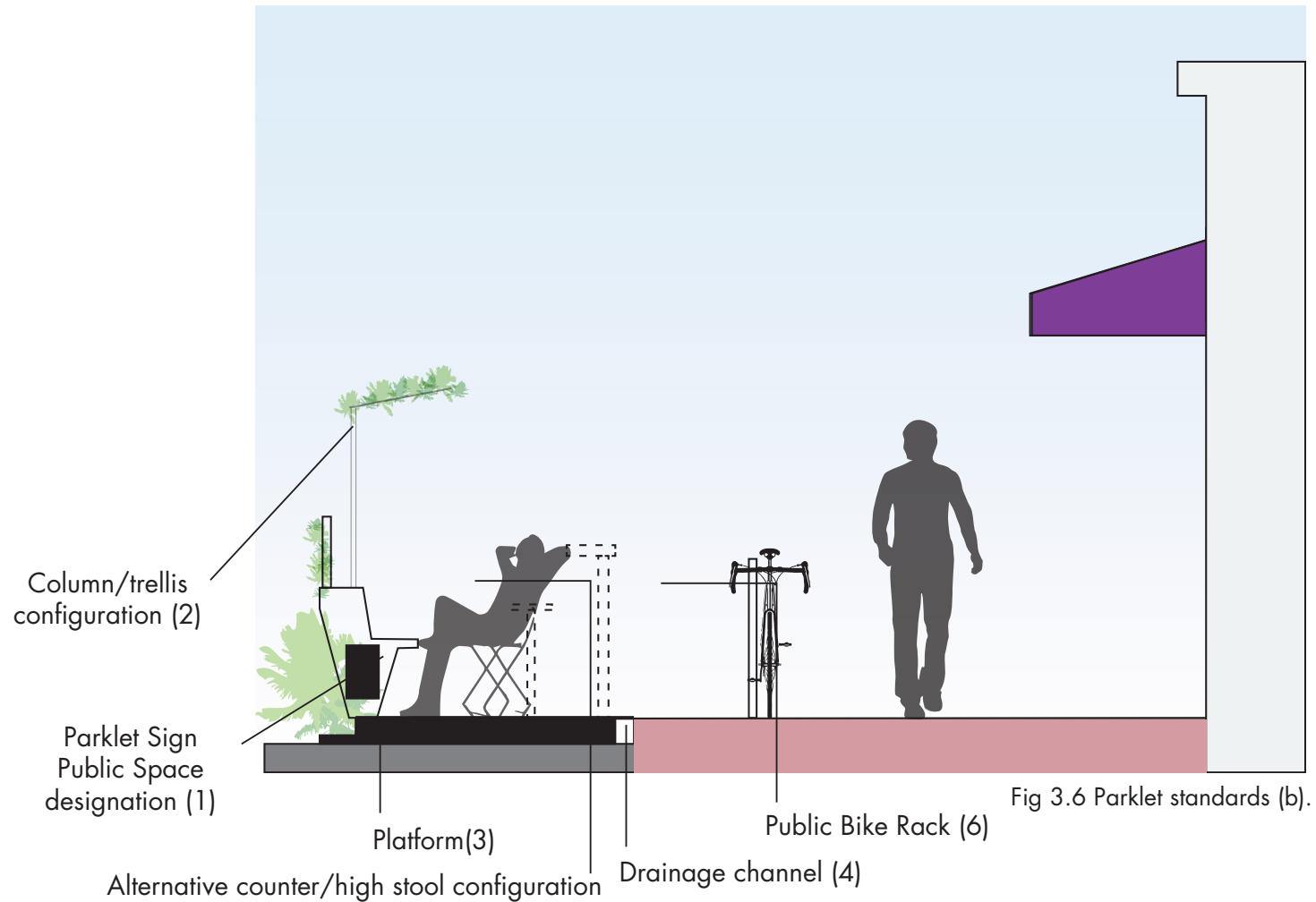



## PARKLETS: TYPES

### COMMON TYPES OF PARKLETS

Currently, most parklets around the country/world are either:

- Sidewalk Extension
- Sidewalk Cafe
- Landscape Lounge

Among these three types, designs and construction materials may vary greatly and is dependent on artistic vision while considering sustainable materials and surrounding context. The following are examples of possible configurations of the various types of parklets. Parklets are versatile in style and function. So far, designs have incorporated seating, gardens, bicycle parking, small lending libraries, performance stages exclusively or in various combinations. Design schools, stake holders and government entities usually host competitions for innovative parklet design and programming.

The parklets on these pages illustrate a few examples of designs from around the country and internationally. Most parklets tend to incorporate bicycle parking, seating and landscape elements. Parklets have permanent structures, however, they may be removed/relocated with relative ease if any street repairs are needed. In addition, parklets may be temporarily closed without need of removal. IE: access to manholes and drainage channel cleaning.

#### THE SIDEWALK EXTENSION (1)

Commonly used when sidewalks are not wide enough for the amount of foot traffic they support. Sidewalk extensions provide extra room for pedestrians as well as comfortable and aesthetically pleasing places to sit and relax. Sitting structures are usually located on the perimeter of the parklet; this allows a seamless extension of the sidewalk. Sidewalk extension configurations feature built-in seating and in some cases built-in tables

#### SPONSOR DAILY RESPONSIBILITIES:

- Water plants, remove dead plants.
- Maintain parklet free of debris and garbage.
- Maintain drainage channel clean.



credit: San Francisco Planning Department



credit: [dailycars-us.blogspot.com](http://dailycars-us.blogspot.com)



- Remove unauthorized graffiti.
- Report any accidents as they occur.
- Monitor and fix any damaged elements.

THE SIDEWALK CAFE (2)

Sidewalk cafe configurations, are commonly but not exclusively found along street-fronting businesses serving food and beverages. Sidewalk cafe parklets feature movable furniture that offers a larger versatility of use. Parklet users don't need to be patrons of the sponsoring community partner, however, a high number of users found in this type of parklets usually are. The sidewalk cafe parklet provides a great place for a meeting, a place to enjoy lunch or catch up with work.

SPONSOR DAILY RESPONSIBILITIES:

- Store all movable furniture after business hours.
- Water plants, remove dead plants.
- Maintain parklet free of debris and garbage.
- Maintain drainage channel clean.
- Remove unauthorized graffiti.
- Report any accidents as they occur.
- Monitor and fix any damaged elements.



credit: labikas.files.wordpress.com



credit: www.berkeleyside.com



## PARKLETS: TYPES



credit: [hblog.archpaper.com](http://hblog.archpaper.com)



credit: [www.gehlarchitects.com](http://www.gehlarchitects.com)



credit: [www.sustainablecitiescollective.com](http://www.sustainablecitiescollective.com)

### THE LANDSCAPE LOUNGE (3)

The landscape lounge configuration features creative designs of built-in seating while integrating abundant landscaping elements. This type of parklet is perfect for relaxing and people watching.

Steps, planters and slopes are common elements found in lounge parklets.

#### SPONSOR DAILY RESPONSIBILITIES:

- Water plants, remove dead plants.
- Maintain parklet free of debris and garbage.
- Maintain drainage channel clean.
- Remove unauthorized graffiti.
- Report any accidents as they occur.
- Monitor and fix any damaged elements.



**WHY PARKLETS?**

Parklets serve many functions. Physically, they help with traffic calming by creating the chicane effect. In addition, parklets turn a few parking spaces into people-oriented spaces; they help expand the usable open space network in the city, providing people with places to gather. Parklets may also serve as additional seating for restaurants and cafes while generally increasing/encouraging pedestrian activity and non-motorized modes of transportation.

**WHO CAN APPLY FOR A PARKLET?**

Parklets are sponsored by: Business Improvement Districts (BID's), Community Benefit Districts (CBD's), community organizations, non-profit agencies, storefront business owners or tenants, property owners (commercial or residential) and other eligible organizations may apply to become Community Partners who are then responsible for the operation, maintenance and management of the parklet. However, parklet amenities must remain open and free to use by any member of the public.

**ARE PARKLETS OPEN TO THE PUBLIC?**

Yes. Parklets are considered public open space. If a parklet is located in front of a business, parklet users don't need to be patrons to enjoy the parklet.

**HOW LONG WILL IT TAKE TO INSTALL A PARKLET?**

Installation takes about one to two weeks, the entire process from application to approval may take 3 to 6 months.

**PARKLET LANDSCAPING**

Landscaping elements are encouraged in parklet design due to the fact that they increase patches for habitat and are aesthetically pleasing. All landscaping maintenance is the responsibility of the parklet sponsor.

**WHERE CAN A PARKLET BE LOCATED?**

Parklets are mostly installed on parallel or angle parking spots along the right of way of low to moderate speed streets. However, parklets may also be installed in medians, excess asphalt space at irregular intersections, traffic circles, and along the frontage of uncovered parking lots.

**HOW MUCH DOES A PARKLET COST?**

If a permit is granted, the sponsor is responsible for:

- The system-wide revenue generated by a single metered parking space or the highest annual revenue generated by a single metered parking space multiplied by the number of spaces occupied by the parklet.
- \$200 for site inspection before and after installation.
- All costs related to design, materials and installation.
- In case of removal, the sponsor is responsible for all removal costs.

**WHAT IF A PARKLET GETS VANDALIZED OR DAMAGED?**

Parklet sponsors are responsible for the ongoing maintenance the parklet including replacing, painting or fixing elements damaged due to vandalism.

**ARE PARKLETS ADA ACCESSIBLE?**

All parklet designs shall contain at least 1 ADA compliant accessible entrance.

**HOW LONG IS A TYPICAL PARKLET?**

Parklets are usually 1 to 3 parallel parking spaces in length or its equivalent in angled parking. In cases where community partners desire corridor-long interventions, further coordination and in depth feasibility studies are necessary.

**WHAT HAPPENS TO MOVABLE FURNITURE?**

Community partners are responsible for upkeep of any movable furniture. In addition, all movable parts of the parklet must be locked or stored after business hours.

**PARKLET LANDSCAPING**

Landscaping elements are encouraged in parklet design due to the fact that they increase patches for habitat and are aesthetically pleasing. All landscaping maintenance is the responsibility of the parklet sponsor

**WHAT IS GENERAL PARKLET MAINTENANCE?**

Sponsors, as mentioned in this section as responsible for general maintenance including furniture and non-approved graffiti removal. In addition, community partners must maintain the area under the parklet free of debris in order to allow proper drainage, and power wash parklet annually or more often if necessary.

**CAN I APPLY FOR A PARKLET IF MY BUSINESS DOES NOT FACE THE STREET?**

No. Only street-fronting property owners, or tenants may apply for a parklet.

**DO APPLICANTS NEED LETTERS OF SUPPORT?**

Parklets are public spaces, applicants must gather letters of support, petitions and other documentation from surrounding businesses or residents in order to prove community outreach and involvement as part of the parklet application process.

**WHAT IS THE PURPOSE OF A PARKLET?**

Passive:

Typically parklets have been implemented for passive uses like sitting to take a break from walking or as a small plaza where parklet users can have their lunch or a cup of coffee.

Active:

However, parklets may also support active recreation or public services depending on the sponsor. For instance: A parklet sponsored by a sporting good store may host related events on the parklet like parklet bootcamp, yoga class etc. In addition, the parklet may support a bicycle pump, and repair, exercise equipment or other creative and active uses as long as they are available to the general public without the need of being patrons of the sponsoring business.

Bike Corrals:







## **BICYCLE PARKING**

Bicycle parking is often overlooked. The placement, type and frequency of bicycle parking facilities are crucial to the bicycle network and its overall usage. Bicycle parking has the potential to increase business revenue, increase commuter trips and get citizens riding at various times of the day/night.

## BICYCLE PARKING

In order to obtain the goals set forth in this plan, the City of Miami Beach should work with residents, local property owners, business tenants, and government partners to offer more expansive bicycle parking options, including bicycle parking shelters, in-street bicycle parking corrals, and seriously consider the viability of a bicycle commuter center and decorative public art doubling as bicycle parking. Recommendations for improving supply and integrating new types of facilities throughout Miami Beach are described and illustrated in the pages ahead.

### INTRODUCTION

The provision of accessible, attractive, and safe bicycle parking options for both short and long-term use is critically important to supporting bicycling as a viable mode of transportation in Miami Beach. In recent years, the City of Miami Beach, private property owners, and business owners have installed hundreds of new, well-designed bicycle racks, particularly for short-term use. This bicycle parking plan makes recommendations for developing high quality, plentiful, and visible bicycle parking options serving residents and visitors for years to come.

### EXISTING CONDITIONS

Today, there are more than 600 publicly accessible short-term bicycle parking spaces in Miami Beach, and more being added each year. As the map at right indicates, these spaces are created by a variety of bicycle parking types found throughout The City.

Yet, analysis reveals that supply is not meeting the current and coming demand. And in many locations, existing bicycle parking facilities are often undersupplied and/or poorly sited, which detracts from their usefulness and viability.

Unsurprisingly, most of the city's current bicycle parking supply is found where demand is high.

These locations include public parks, at civic buildings, and along commercial streets like Washington Avenue, Lincoln Road, 41st Street, and 71st Street.

The bicycle parking intensity use map this page demonstrates where demand is concentrated. In many of these locations, the

supply but also the quality of the infrastructure needs to be increased.

For example, bicycle parking at key destinations, like gyms, pharmacies, restaurants, and bars is often oversubscribed or in some cases underused because of a poor selection in bicycle parking type and/or placement. Both conditions cause people to choose to lock their bicycles to other vertical elements, like street signs, parking meters, and fences. When this occurs, the city's high number of pedestrians are inconvenienced and made less comfortable as they navigate around bicycle-strewn sidewalks.

In addition, long-term bicycle parking options, for say three hours or more, are few and far between. Bicycle parking of this kind — covered, high security, easily accessible — is needed within residential neighborhoods and at transit hubs, schools, large residential and commercial developments, and employment hubs. Such facilities will encourage more people to bicycle for transportation.

Without an increase in supply, quality, and type, it will be difficult for Miami Beach to obtain the bicycle mode share goals set forth in this plan. A more detailed analysis is found in the pages ahead for South Beach, Mid-Beach, and North Beach.

**600+** BICYCLE PARKING LOCATIONS  
**89** CITIBIKE LOCATIONS  
**6** BICYCLE PARKING TYPES

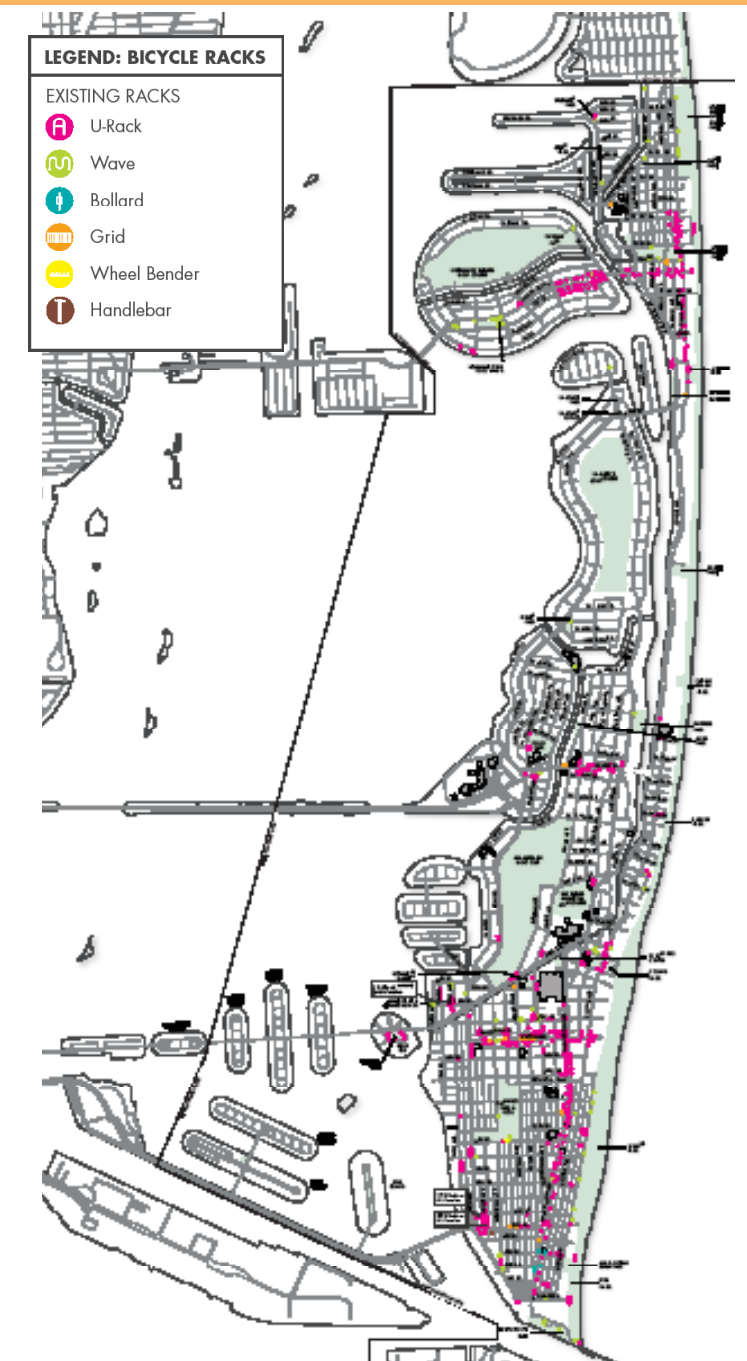

Fig 3.7 City-wide existing bicycle parking locations.

**PROPOSED BICYCLE PARKING**

The bicycle parking plan illustrated at right identifies 804 new locations for bicycle parking. The locations were determined by analyzing land use and urban characteristics, demand, and available space. Each location was then matched with an appropriate type of parking to serve as many users as possible. The analysis revealed that many of the short-term racks found throughout the city do not meet best practice specifications and that long-term parking is almost non-existent. Thus, the following five short and long-term parking facilities types are being recommended.

Short-term Parking Types

- Bike Corral
- Public Art Rack

Long-term Parking Types

- Bicycle Shelter
- Bicycle Locker
- Bicycle Station

These five types, plus the city's standard inverted-u rack, should comprise the bulk of the city's parking in the future.

Fig 3.8 City-wide existing + Proposed bicycle parking locations.



Fig 3.9 City-wide existing bicycle parking intensity.



## BICYCLE PARKING: TYPES & STANDARDS

### BICYCLE RACK SAFETY AND PERFORMANCE STANDARDS

To prevent theft and to ensure public safety, all bicycle racks should meet the following design guidelines:

- Support the frame of the bicycle in at least two locations
- Allow the frame and one wheel to be locked to the rack when both wheels remain on the bike
- Allow the frame and both wheels to be locked to the rack if the bicyclist decides to remove the front wheel
- Allow the use of cable, chain, and U-shaped locks
- Be securely anchored to the ground;
- Be usable by bicycles with bottle cages, panniers, etc.
- Be usable by a variety of bicycle sizes and types (children's bicycles; tricycles, step-through frames, etc.) keep both wheels on the ground.

In addition, all bicycle racks should not be capably compromised by hand tools, especially those that are easily concealed such as wire cutters or screwdrivers. Bicycle racks and the bicycles secured to them should not create a tripping hazard or barrier for pedestrians and the visually impaired (see location standards on page x). Finally, all outdoor bicycle racks and any related facilities should be well-lit and highly visible at night so that users feel safe using them at all hours.

### EVENT-BASED VALET BICYCLE PARKING

Miami Beach is home to an incredible amount of events that draw thousands and thousands of people to concentrated points. One way to manage the stress on the street network is to encourage other forms of transportation, such a cycling. In many instances, doing so could overwhelm the existing bicycle parking infrastructure. Thus, another option is to seek out organizations, like the Green Mobility Network, to help staff, manage, and promote temporary event bicycle parking.

### LONG-TERM BICYCLE PARKING

Long-term bicycle parking facilities are intended for use that generally exceeds two hours (see Table 2). Long-term bicycle parking is associated with residential, workplace, and transit-related land uses where parking for long durations is common. As a result, proximity to the final destination is a lower priority than protection from the elements and guaranteed security.

### BICYCLE SHELTERS

Bicycle shelters provide highly visible, semi-enclosed protection from the elements. Bicycle shelters should be placed at highly frequented bicycle destinations where users tend to park for periods of two-hours or more. Such places include, but are not limited to, employment centers, transit stops, civic buildings, parks, and schools.

Bicycle shelters provide an opportunity to display safety information, a map of the regional and local bicycle network, and/or any other relevant bicycle or local information. The spacing between individual bicycle racks and/or other streetscape elements must be taken into account and should follow the general bicycle parking performance and location standards. Likewise, bicycle shelters should be easily identifiable, well lit at night, and sufficiently protect bicycles from the elements.

Developers of property in Miami Beach may consider pursuing the implementation of bicycle shelters in strategic locations, such as within the grounds of the project. Doing so will raise the profile of bicycling and provide a parking amenity for residents and visitor that provides shelter for longer parking stints.

### BICYCLE LOCKERS

Bike lockers are medium to large in size and depending on size can be located at transit hubs, bus stops, on a high turnover commercial strip, or at pedestrian-only streets. They provide security and shelter and promote multimodal ridership and traffic alleviation.

### BICYCLE STATIONS

Bicycle stations are intended to serve as a local/regional hub for all bicycling activities. Such facilities may offer a wide variety of services, such as secure and attended parking facilities; bicycle rentals; showers, lockers and changing facilities; repair services or facilities; and cafe/social space. The combination of these facilities provides the highest level of bicycle parking service for long-term and frequent use, and will elevate the visibility and viability of bicycling in Miami Beach.

Bicycle stations are most appropriate in urban core, central business district locations, and at transit hubs where bicycle commuters and tourists may maximize the services offered. Cities such as Chicago, IL, Santa Monica, CA, Cambridge, MA, Washington DC, Berkeley, CA, and Long Beach, CA all provide working models.

It is recommended that the City of Miami Beach pursue a bicycle station-like facility in South Beach, within the center city. An ideal location would be within a short distance of Lincoln Road where such a facility would be highly visible and of utility to bicyclists cycling to work. Some ideas include a facility within a municipal parking garages, built within a municipal parking lot, or even in a leased storefront.

### BICYCLE CORRAL RECOMMENDATIONS

The bicycle corral is an increasingly common type of short-term bicycle parking type used where bicycle parking demand is high and sidewalk space is either limited or duly accommodates high volumes of pedestrian traffic. Bicycle corrals most commonly replace automobile parking spaces or are placed within site triangle visibility zones, which still allow for motorist a clear view yet also allow the added amenity of bike parking to be added. Depending on the configuration, a single car space may yield between 6 and 12 bicycle parking spaces within a single corral.



## PUBLIC ART BICYCLE RACKS

The City of Miami Beach standard bicycle rack is already an attractive element in the streetscape. Neighborhood, civic, district, non-profit, institutional, or business groups located within the city should be encouraged to pursue bicycle parking facilities that reinforce an existing cultural, historical, business, or social character. In such instances, custom or public art bicycle racks can creatively address bicycle parking needs while simultaneously enhancing the profile of bicycling and the destination served by such racks. While custom bicycle racks do cost more than off-the-shelf racks, they raise the profile and visibility of bicycling in general, and improve the public perception regarding city or organizational/business values. They also bring positive attention to bicyclists for making sustainable and healthy transportation choices.

However, many art rack designs unintentionally undermine the intended function, often resulting in inefficient or unrecognizable facilities that are avoided by users. Therefore, the provision of art racks must meet or surpass the guidelines and performance standards in this Plan.

## BICYCLE PARKING LOCATION + PERFORMANCE STANDARDS

The use of bicycle parking and other end-of-trip facilities is largely dependent on their location. Similar to motorists, bicyclists desire to park as close and as conveniently to their destination(s) as possible. However, the degree of proximity may vary by the type of facility being provided and the type of trip/user it is intended to serve.

Short-term parking facilities, like bicycle racks, should be located as close as possible to the destination(s) they serve. This is especially important for streets served by concentrations of retail where any prolonged effort to find adequate bicycle parking is as frustrating for the bicyclist as circling

the block for vehicle parking is for the motorist. Long-term parking, such as bicycle stations or shelters, should also be as convenient as possible. However, the protection from inclement weather and the enhanced level of safety/service that such facilities provide often compensates for lack of immediate proximity. Similarly, shower, changing rooms, and locker facilities need not be located inside the destination they serve, but should provide enough access and measurable convenience that commuting by bicycle is as easy as possible for the greatest number of people. Employers unable to provide such facilities may consider negotiating access with nearby fitness gyms for their bicycling employees.

Short- and long-term bicycle parking facilities should adhere to the following location and standards. In general, safe bicycle rack locations should:

- Maximize visibility and minimize opportunities for vandalism by being located in locations within easy view of pedestrian traffic, windows, doors, and/or well-lit areas.
- Protect bicycles from inclement weather, as long as the facilities meet or exceed visibility, spacing, and performance standards.
- Locate bicycles a safe distance away from automobiles parked on-street, in lots, or in structures so that bicycles will not be damaged by opening doors or errant driving behavior.
- Not obstruct pedestrian traffic in any way by providing at least 5 feet in clear path.
- Place the rack(s) between the primary road/path used by bicyclists and the entrance to the destination(s) they serve.
- Not be located on or near stairs, walls, berms, or within handicap accessible ramps.
- Provide enough space for bicycles of all types to

maximize the bicycle parking capacity of a given facility.

Specifically, bicycle racks for short-term parking should be located



Fig 3.10 Bicycle parking types matrix.

EXISTING BICYCLE PARKING

PROPOSED BICYCLE PARKING

STREETSCAPE



## BICYCLE PARKING: TYPES



Bicycle parking corrals help maintain a clear sidewalk, increase overall parking supply, and often become social spaces.



Bike Station Store Front and parking lot.



Efficient, safe parking inside a bicycle station.



Adding a bike valet can help attract hundreds of cyclists who might have otherwise driven.



Art rack located next to a Parklet.



Bike Station, Washington D.C.



Bicycle parking types range from basic bicycle racks to semi-enclosed bicycle shelters, to full “bike stations” that provide a combination of amenities that include indoor bicycle storage, repair facilities, showers, lockers, changing rooms, rentals, and even café/social gathering spaces. While countless bicycle parking designs and configurations exist, they may be described as two overarching types: short- and long-term parking. Each of these types is explained below.

Short-term parking facilities consist of standard bicycle racks, and temporary event “valet” parking. Long-term parking facilities include semi-enclosed bicycle shelters, fully enclosed bicycle lockers, and fully enclosed bicycle stations/storage rooms. Matching each of these types and the available configurations to the right land use context is not difficult, but requires an analysis of the following conditions.

- Intended bicycle user group
- Length for which bicycles are likely to be parked
- Proposed location and surrounding land uses
- Local climate considerations (shade, rain)
- Ability of the proposed facility to provide orderly, safe, and attractive bicycle parking
- Basic performance standards and parking site guidelines
- Currently, the City of Miami Beach offers no long-term parking facilities.

## SHORT-TERM BICYCLE PARKING

The majority of bicycle parking facilities are intended for short-term use, generally less than three hours. Short-term bicycle parking is generally associated with commercial/retail, civic, and/or recreational land uses. As a result, proximity to destination is often prioritized over protection from weather and absolute security. Beyond the use of a personal bicycle lock and the quality of the rack, passive surveillance — otherwise known as “eyes on the street” — is the only security provided

## BICYCLE RACKS

Bicycle racks allow for the temporary storage of bicycles in a safe and organized manner. The most effective types are those which are easy to identify visually, efficient in their ability to accommodate the intended amount of parked bicycles, allow for easy bicycle maneuverability in and out of the designated bicycle parking space, enable the bicycle to be secured properly by providing at least two points of contact with the bicycle frame, and allow both the frame and the wheel to be secured to the bicycle rack.

Two simple and recommended forms that meet these standards are the inverted “U” Rack and the “Post and Ring.” The former comprises the standard Miami Beach city rack.

## BICYCLE RACKS LOCATION RECOMMENDATIONS

It is recommended that the city’s standard bicycle racks be considered as a replacement to those locations where bicycle racks do not currently meet the design standards included in this plan.



The above bicycle parking is well-spaced, properly oriented parallel to the curb, and a safe distance from the tree and the curb.



Placement of bike parking is integral for success. Without adequate supply and visibility, bicyclists will lock their bicycles to the nearest vertical element. Low bike efficiency. Correct placement of parking provides a clear pedestrian through zone.



## BICYCLE PARKING: STANDARDS

Fig 3.11 Bike parking on sidewalk. (a)

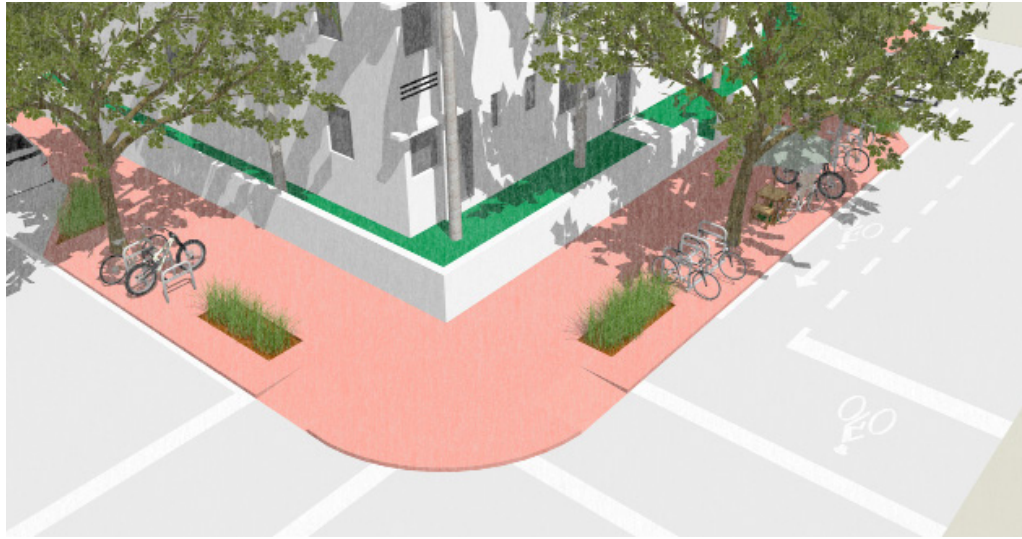

The temporary materials may be replaced by more permanent infrastructure, such as wider sidewalks, rain gardens, trees, public seating, and bicycle parking.

Fig 3.12 Bike parking on sidewalk. (b)



The result is a more environmentally-friendly and amenity laden streetscape for the neighborhoods of Miami Beach.



Bicycle parking located next to bicycle facilities promotes ridership. This particular set up elevates the perception of bicyclists belonging as users of the travel way.



Parklets extend the pedestrian realm, provide a wider through zone for pedestrian travel as well as a wider furnishing zone. Bike Parking can be incorporated into the parklet.



Bicycle racks should be clearly visible from the approach to a destination's most actively used entrance. If located along a sidewalk, within the public right-of-way, bicycle parking should be visible from the street for which the sidewalk serves. Additionally, a large, single bicycle rack cluster should not serve an entire urban block. Rather, it is preferable to place several smaller rack clusters, or even single bicycle racks in multiple, convenient locations along the sidewalk.

## SIGNS

If a bicycle parking facility is unable to be sited visibly in front of the destination it serves, or in another conspicuous location, then attractive signs should be provided at all primary entrances to direct bicyclists to the nearest bicycle parking location.

## CLEAR PATH

Bicycle racks, shelters, lockers, and bicycle sharing stations must allow a minimum clear path of five feet in width so that pedestrians and disabled people may move past without obstruction.

## CURB CLEARANCE

If located parallel to the thoroughfare, all bicycle racks must be placed at least 24 inches from the curb. Those placed perpendicular to the curb, however, must locate the nearest vertical component of the rack at a minimum of 48 inches from the curb's edge. Both dimension requirements will help prevent bicycles from being struck by car doors or moving motor vehicles.

## DISTANCE BETWEEN RACKS

Bicycle racks aligned parallel to each other must be at least 36 inches apart. This includes racks that are sold as multiple rack units, which may be attached together. Racks that are aligned end-to-end should be at least 96 inches apart.

## DISTANCE FROM WALLS/MAINTAIN PEDESTRIAN AISLE

To ensure safe maneuvering and circulation, bicycle racks placed perpendicular to a wall must be at least four feet from the wall to the nearest vertical component of the rack. Bicycle racks placed parallel to a wall must be at least three feet from the wall. For indoor racks placed in groups, an adequate pedestrian aisle must be provided so that bicyclists can access and maneuver their bicycles in and out of the parking position. Bicycle racks

Fig 3.13 Underutilized curbside space at corner

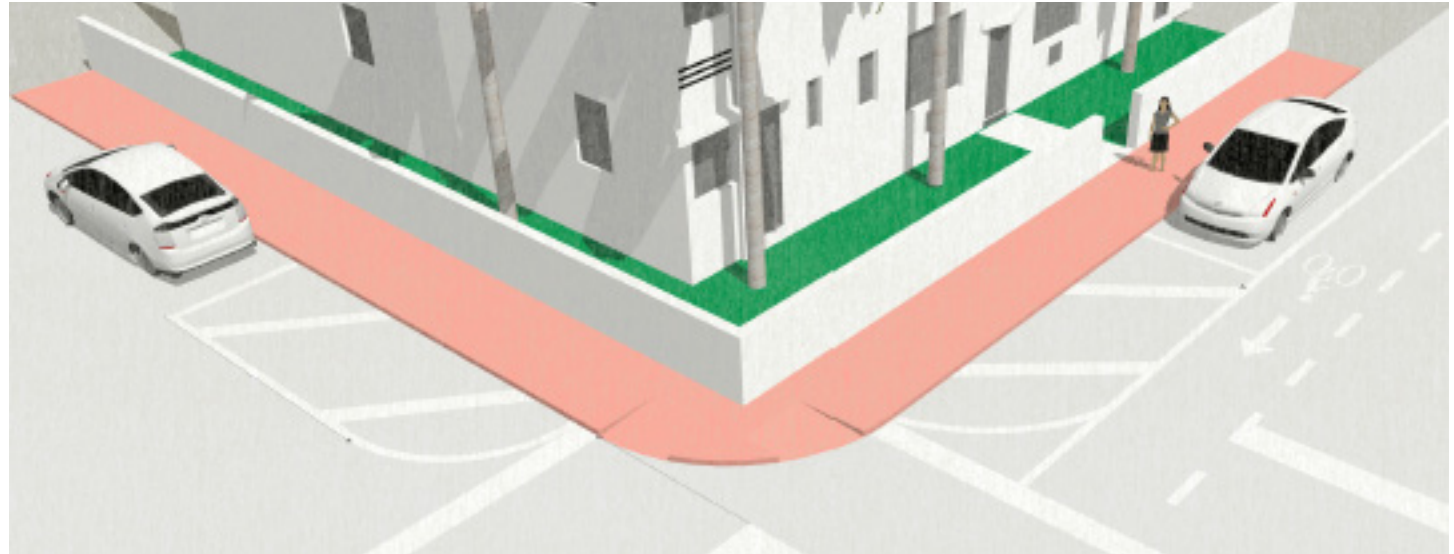

Within residential neighborhoods, underutilized curbside space may be put to more efficient use.

Fig 3.14 Bicycle parking/ corral at corner

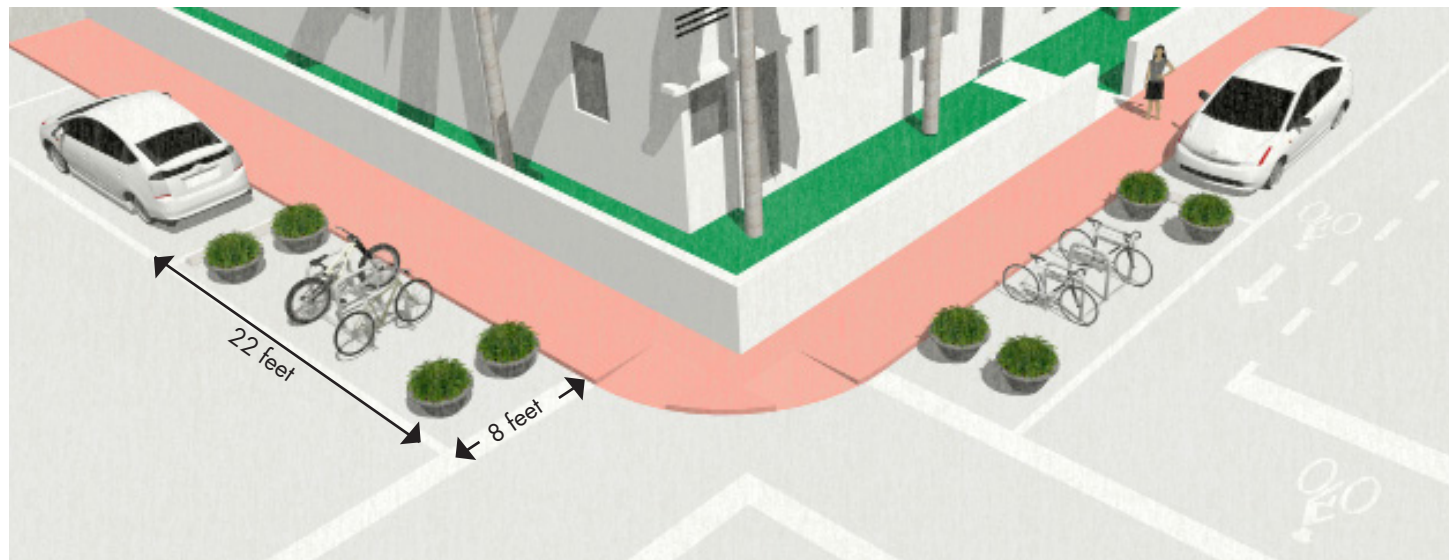

In the short-term, temporary and low-cost materials may be used to provide landscape and bicycle parking amenities, while also maintaining visibility at the intersections for people driving.

placed perpendicular to a pedestrian aisle must be at least four feet from the aisle. Pedestrian aisles should be at least five feet wide wherever possible.

### OTHER RECOMMENDED SITE DISTANCES

To ensure safety and convenience, bicycle racks should be located:

- 15 feet from fire hydrants, bus stops, taxi stands, hotel loading zones, transit stops, newspaper kiosks, etc.
- 10 feet from intersections/driveways/curb cuts five feet from any standpipes, or above-ground vertical structures like signs, meters, lights, mail boxes, planters, public bathrooms, pay phones, etc.
- Three feet from tree pit edges, grates, utility covers, etc.

### POLICY + IMPLEMENTATION

It is the intent of this Bicycle Parking Plan to foster bicycling as a viable, safe, and sustainable form of recreation and transportation. Implementing bicycle parking and other end-of-trip facilities plays a key role in realizing this goal.

This Miami Beach Bicycle Parking Plan is conceived at the scale of the city, but will ultimately be implemented at the block and individual building scale as property is developed and redeveloped, and as requested by property and storeowners. Specific site analysis should be undertaken so that bicycle parking remains convenient, visible, and located properly in relation to the destinations and bicyclists it serves.

Like the overall bicycle network plan, the bicycle parking must be implemented in cooperation with a number of inter-related city, county, state, and private entities that have jurisdiction over the governance and physical development of Miami Beach and its public right-of-ways.

### OPT-IN PROGRAMS

Many municipalities have created bicycle parking programs

that encourage public and private partnerships that reduce the cost of purchasing and installing bike racks while simultaneously expanding the supply. For example, 50-50 match bicycle parking implementation programs encourage businesses to partner with the municipality to help cover the cost that ultimately serves them well. Such programs are worth researching and potentially adapting to certain contexts within Miami Beach.

Encouraging bicycle parking means inviting local property and business owners to help expand the supply to meet their tenant, employee, and customer needs. In some instances, upgrading bicycle parking facilities will be needed. Should property owners currently supply facilities that are less than desirable then this program should help them make their bicycle accommodations more robust.

### MAINTENANCE

Once implemented, bicycle parking facilities of all types must be well maintained. All facilities should be kept clean, orderly, free of abandoned bicycles, bicycle locks, and other debris. These steps will help ensure that bicycle parking is used safely and frequently. To remain attractive and functional, areas around the bicycle parking facility—whether it be a rack, shelter or otherwise—must remain well-paved, mowed, plowed, or otherwise tended and cared for so that bicyclists are not deterred from using the facility. The security of bicycle racks and other long-term parking facilities should be checked periodically so that each remains free from vandalism. This includes checking the function of lighting, enclosure conditions, and changing key codes or key fittings after facility use turnover. Failing to meet basic maintenance standards will deter use and create additional opportunities for theft.

The responsibility for maintenance should be conferred upon the sponsoring entity (developer, businesses, individual property owner, etc.), or agreed upon between mutual public/private parties and/or multi-jurisdictional interests. This will help ensure that bicycle parking remains viable, safe, and attractive.

### BICYCLE PARKING RATIOS

The City of Miami Beach does not currently require bicycle parking to serve new development. It should. The bicycle parking ratio table on the opposite page is intended to inform the inclusion of bicycle parking into the city's zoning code. Doing so will help the city meet current and future demand, support the ongoing viability of two-wheel travel, and ultimately help the city to obtain the mode share goals set forth in this plan. The bicycle parking ratios are organized by short and long-term parking types and are keyed into the city's land use categories using square footage, employee, and/org building function to guide implementation. Peer cities with excellent bicycle parking requirements include Santa Monica, CA, Cambridge, MA, and Portland, OR. This guidance is intended to aid the city so long as it's bicycle mode share remains at or below 10 percent. That said, Miami Beach is a very dynamic place. New development and changing land uses are common, with some serving as major bicycle trip generators. Thus, in some locations the supply may need to be increased and the parking type changed. For example, frequently oversubscribed bicycle racks on a sidewalk may be removed in favor of an in-street bicycle corral so as to serve the demand better and lessen the clutter for people walking on the sidewalk. Bicycle parking ratios and requirements should be reviewed in conjunction with each bicycle master plan update, or at least every five years.



| LAND USE   | SHORT-TERM BIKE PARKING  | LONG-TERM BIKE PARKING  |
|--|--|---|
| <b>Single-Family Residential</b> (RS-1, RS-2, RS-3, RS-4,TH)                             | No spaces required   | No spaces required  |
| <b>Multifamily Dwelling</b>  |  |   |
| a) RM-1, RM-2, RM-PRD1, RPS-1, RPS-2   | 0.05 spaces/bedroom, min. 4 spaces   | 0.5 spaces/bedroom, minimum 4 spaces  |
| b) RM-3, RMPS-1, RM-PRD2, RPS-3, RPS-4   | 0.1 spaces/bedroom, min. 8 spaces  | 0.75 spaces/bedroom   |
| <b>Civic and Government Use</b> (GU, CCC, WD2, MR)                                       |  |   |
|  | 1 space/20 persons of allowed capacity   | 1 space/10 employees  |
| a) assembly (church, stadium, convention center etc.)                                    | 1 space/15 persons of allowed capacity   | .25 space/15 persons of allowed capacity  |
| b) non-assembly (library, marina, government building etc.)                              | 1 space/8,000 s.f. of floor area, min. 4 spaces  | 1 space/10 employees, min. 2 spaces   |
| <b>Education</b> (GU,SPE, CD-1, CD-2, CD-3)  |  |   |
| a) public/private day-care centers for 15 or more children                               | 1 space/20 students of planned capacity, min. 2 spaces                                 | 1 space/10 employees, min. 1 space  |
| b) public/private nursery schools, kindergartens, elementary schools (grade 1-4)         | 1.0 space/20 students of planned capacity, min. 2 spaces                               | 0.5 space/per classroom, min. 1 space   |
| c) public/private junior high (grade 5-8), and high schools (grade 9-12)                 | 1.5 space/20 students of planned capacity  | 1 space/10 employees, AND 1 space/20 students of planned capacity                         |
| <b>Hospitals/Healthcare Institutions</b> (HD)  | 1 space/5,000 s.f. of floor area, min. 4 spaces  | 1 space/10,000 s.f. of floor area, or 1/10 employees, whichever is greater, min. 4 spaces |
| <b>Transit Hub</b>   |  |   |
| a) rail station and high-use bus stops   | Consider spaces for 1.5% of a.m. peak period daily ridership                           | Consider spaces for 10% of projected a.m. peak period daily ridership                     |
| b) off-street parking lots/garages available to the general public, with or without fees | Minimum of 6 spaces or 1 per 20 auto spaces. Unattended surface parking lots excepted. | 1 space for each 20 automobile spaces* Unattended surface parking lots excepted.          |



# BICYCLE PARKING: IMPLEMENTATION

**Commercial** (CD-1,2,3, RO, CPS-1,2,3,4 TC-1,2, TC-3,TC-3c, MXE)

|   |  |                                     |
|---|--|-------------------------------------|
| a) restaurant (restaurant, coffee shop, cafe etc.)        | 1 space for each 2,500 s.f. of floor area, min. 2 spaces | 1 space/10 employees, min. 2 spaces |
| b) general food (grocery, convenience store, etc.)        | 1 space for each 5,000 s.f. of floor area, min. 2 spaces | 1 space/10 employees, min. 2 spaces |
| c) general retail (clothing, souvenirs, electronics etc.) | 1 space for each 1,000 s.f. of floor area, min. 2 space  | 1 space/10 employees, min. 2 spaces |
| d) office   | 1 space for each 8,000 s.f. of floor area, min. 2 spaces | 1 space/10 employees, min. 2 spaces |

**Urban Light Industrial** (I-1)

1 space for each 10,000 s.f. of floor area, minimum of 4 spaces  
 1 space/15,000 s.f. of floor area, minimum of 2 spaces

Fig. 5.14 land use and bike parking types matrix.

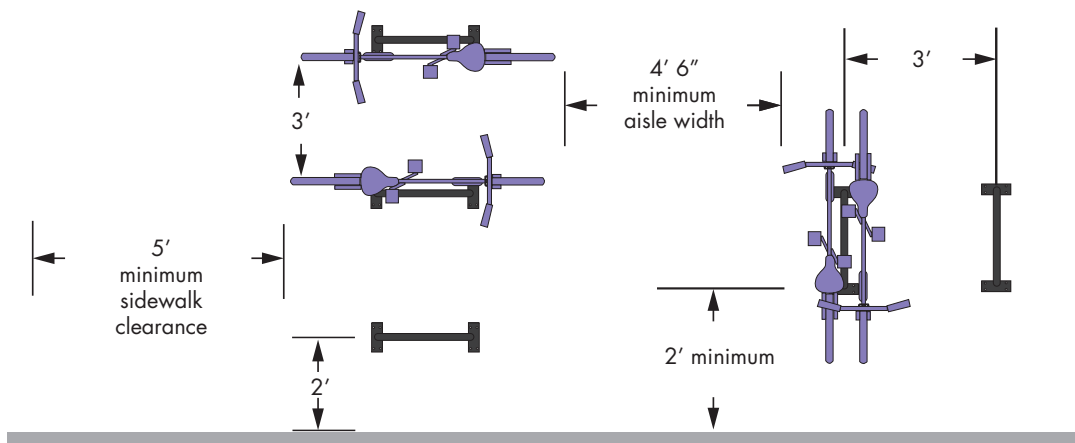

Fig 3.15 Inverted U bicycle parking installation standards.

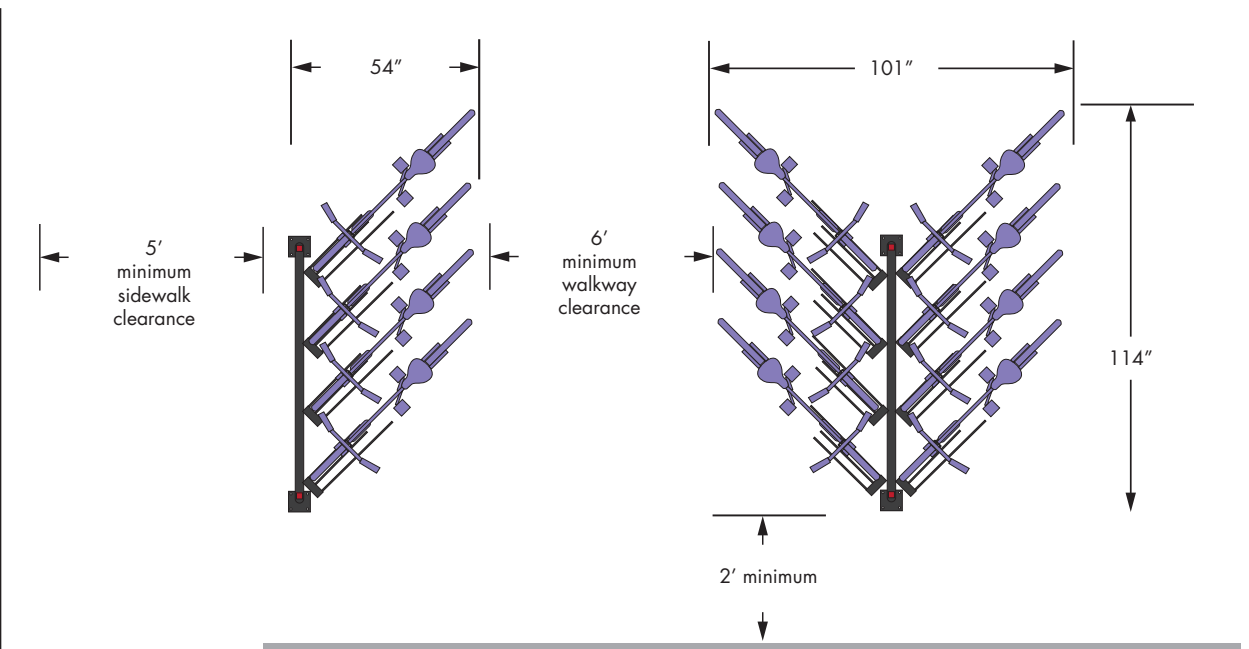
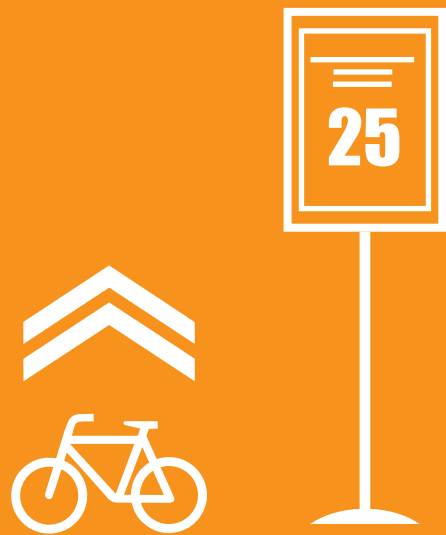

Fig 3.16 Bike stall installation standards.



## SIGNALS & SIGNS

Vertical signalization refers to signs affixed to posts or other structures which serve to inform all users of the public realm of potential hazards, speed limit, and information necessary to navigate the streets at ease like location of landmarks for wayfinding.

Horizontal signalization refers to various pavement markings, in-pavement detection signals for all users and elements that define the cyclist travel way separate from motor-vehicles.

## SIGNALS & SIGNS: VERTICAL

Intersections must be calibrated to accommodate all users. Implementation of appropriate signals and calibrated timing are also of equal importance to minimize conflict among users.

The design of signal timing varies by context, however, timing must be optimized along corridors and geared towards serving users in the appropriate level of priority.

### PEDESTRIAN ACTUATED SIGNALS:

These signals integrate a push button that activates a “WALK / DON’T WALK” interval. Actuated pedestrian signals are sometimes paired with accessible technology that are user activated and also provide both spoken and visual assistance. Accessible pedestrian signals are audible using a simple steady sound to cue pedestrians informing them of crossing time while being unobtrusive. Accessible pedestrian signals are also known as: Acoustic signals, audible pedestrian crossing signals and audio-tactile signals. Pedestrian Actuated Signals provide directional information either spoken, written, or in Braille.

### PEDESTRIAN FIXED SIGNALS:

Fixed signals are the signals commonly found on most roads. These signals are predictable and usually require less maintenance than actuated signals.

Fixed signals are commonly found in urban settings. They make complex interactions most predictable for all users. In most cases, however, they must be calibrated to serve pedestrian priorities first. This means that crossing intervals are sufficiently long for crossing while coordinating with adjacent signals.

At crossings where the signal is uncoordinated with adjacent traffic signals (free setting), designers can reduce pedestrian delay by reducing the minimum green time. At coordinated signal locations, designers have multiple options to decrease delay, including increasing the permissive window, adjusting signal timing for responsiveness at certain times of day, and setting the signal to recall on the pedestrian phase.

### BICYCLE SIGNAL HEADS

A bicycle signal is traffic control device that should be used solely in conjunction with an existing conventional traffic signal or hybrid beacon. Bicycle signals are commonly used to improve identified safety or operational problems involving bicycle facilities, or to provide guidance for bicycle only movements and leading bicycle intervals. Bicycle signal heads shall be installed at signalized intersections to indicate bicycle-specific timing strategies or signal phases. In The United States, a vertical 3 lens signal (red, yellow and green) is used.

### BENEFITS

- Improves level of safety at high conflict areas.
- Helps to simplify traffic movements for bicycles and clarifies bike-specific movements for all users.
- Accommodates bicycle-only movements in complex intersections. (Bicycles may travel parallel to automobiles using the same signal if conflicting turns are restricted).
- Provides priority to bicycle movements at intersections.
- Minimize conflicts between pedestrians and bicyclists.

An adequate clearance interval (i.e., the movement’s combined time for the yellow and all-red phases) shall be provided to

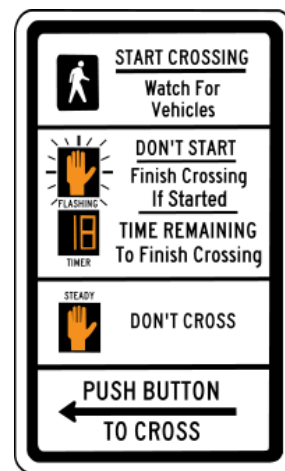

Fig 3.17 MUTCD - R10 3e

ensure that bicyclists entering the intersection during the green phase have sufficient time to safely clear the intersection before conflicting movements receive a green light.

### TYPICAL APPLICATIONS

Where a bicycle facility or shared path crosses a street, particularly where the necessary bicycle clearance time is substantially different from necessary pedestrian clearance time.

- At intersections where bicycle facilities may change (IE: Sidewalk-level protected bike lane to regular bike lane) if turning movements are significant.
- At intersections with contra-flow bike lanes that otherwise would not have a signal indication.
- At intersections with high number of motor vehicles and bicycle collisions.
- At intersections nearby schools and parks.
- To make it legal for bicycles to enter an intersection during an all-pedestrian phase ( may not be appropriate in some cities).
- To give bicycles a leading green light at intersections or to indicate an all-bike phase where turning movement volumes are significant.



credit: www.flickr.com



**BICYCLE SIGNAL DETECTION & ACTUATION**

Bicycle detection is used at actuated signals to alert the signal controller of bicycle crossing demand at an intersection. Bicycle detection can be activated through the use of push buttons just like pedestrian activated signals or it can occur automatically through detection mechanisms like microwaves, video or in-pavement loops, etc.

**MICROWAVE**

Miniature microwave radar that picks up non- background targets. It is more cost effective than video and is not affected by weather, or sun light changes.

Currently, Pleasanton, California is the only municipality in the country using this technology. Cyclists have reported improved efficiency and safety.

The microwave sensors are able to monitor up to eight detection zones, specified by the city, and can send up to four commands to the traffic signal control box; ie: "straight through", "left turn". The system updates information 20 times per second and is able to track moving and stationary vehicles.

Microwave systems cover a large area, allowing the cyclist to be positioned freely at the intersection while still being detected.

**VIDEO**

Video detection is aimed and calibrated to detect bicyclists. While this system might be effective for South Florida climate, the continuous video monitoring may cause a privacy concern.



**PUSH BUTTON**

User activated push button mounted on a pole facing the street. Push buttons must be installed in a way that allows the cyclist to reach the button without dismounting the bicycle. In addition, a rest bar may be implemented along routes with expected heavy bicycle traffic.



credit: www.bicyclenetwork.com.au



credit: www.garyridesbikes.blogspot.com



credit: www.seattlebikeblog.com

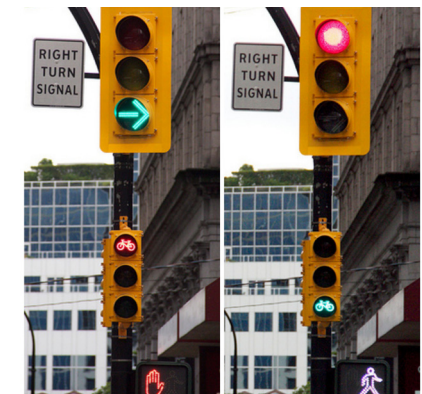

A minimum of 7 seconds is required for the **WALK** signal.

Short cycle lengths of 60–90 seconds are ideal for urban areas that allow frequent gaps and consistent crossing opportunities, creating a more permeable network for pedestrians and bicyclists.



## SIGNALS & SIGNS: VERTICAL

### HYBRID BEACON FOR BIKE ROUTE CROSSING OF MAJOR STREET:

A Hybrid beacon or High-Intensity Activated Crosswalk (HAWK), is made up of a signal-head with 2 red lenses over a yellow lens on the major street, and pedestrian/or bicycle signals on the minor streets. The minor street approaches don't have signals for motor vehicles.

HAWKs are used to improve non-motorized crossings on major streets in places where the volume in the side streets does not support the installation of a conventional traffic signal. In addition, HAWKs can be installed on side streets instead of regular signal heads if there is a concern that a signal head might encourage additional motor traffic on sides streets.



credit: www.fhwa.dot.gov

|   |  |  |    |
|---|--|--|----|
| 1 |  |  |    |
| 2 |  |  |    |
| 3 |  |  |    |
| 4 |  |  |    |
| 4 |  |  |    |
| 5 |  |  | 15 |
| 6 |  |  | 10 |
| 7 |  |  | 5  |
| 8 |  |  |    |
| 1 |  |  |    |

Fig 3.18 MUTCD sequence for Pedestrian Hybrid Beacon (Interim approval July 2008)

### YIELD SIGNS

TURNING VEHICLES YIELD TO BICYCLES AND PEDESTRIANS (R10-15 alt.) sign may be used to show a permissive left or right turn to motorists who are required to yield to bicyclists at the crossing. If used at a crossing, the sign should be mounted on the far side of the intersection to improve visibility to left turning motorists. If possible, it should be mounted on the vehicle sign face.



Fig 3.19 MUTCD R-10-15 alt.

YIELD HERE TO BICYCLES (R1-5 alt. A) is used at locations where yield lines are provided to denote the location for motorists to yield to bicyclists in crossings of separated bike lanes. If the yield condition includes pedestrians, the YIELD HERE TO BICYCLES AND PEDESTRIANS (R1-5 alt. B) sign should be used.

These signs are not required, and should not be used in locations where sign clutter is an issue; however, these signs may prevent collisions in areas of high traffic volumes and should be considered.

The BEGIN RIGHT TURN YIELD TO BIKES sign (R4-4) should be placed at locations where the beginning of the right turn lane is also the merge point where motorists cross the separated bike lane

The YIELD sign (R1-2) may be used to warn bicyclists merging into a travel lane, or to warn motorists of other motorists when merging or at roundabouts.



Fig 3.20 R-10-15 alt. A



Fig 3.21 R-10-15 alt. B



Fig 3.22 MUTCD R4-4



Fig 3.23 MUTCD R1-2

**Warning Signs**

The BICYCLE WARNING sign (W11-1) may be placed at, or in advance of, uncontrolled crossings of separated bike lanes to alert motorists of approaching bicyclists. Using this sign should be limited to locations where the bike lane might be unexpected to crossing motorists. A TWO-WAY (W1-7 alt.) supporting plaque should be mounted below the W11-1 where the separated bike lane operates as a two-way facility



Fig 3.24 MUTCD W11-1



Fig 3.25 MUTCD W1-7 alt.



Fig 3.26 MUTCD W11-15  
The BICYCLE/PEDESTRIAN WARNING sign (W11-15) may be used as a substitute of the W11-1 where a sidewalk is parallel to the separated bike lane and motorists may not be expecting to cross either the bicycle or pedestrian crossing

**Confirmation Signs (1)**

These signs are indicate to bicyclists that they are on a designated bikeway while at the same time, they alert motorists of bicycle priority or bicyclists presence along a particular street.

**MUTCD PLACEMENT**

Every 1/4 to 1/2 mile on off-street bike facilities like shared paths and sidewalk-level protected bike lanes.  
Every 2 to 3 blocks along on- street bicycle facilities unless another type of sign is used within 150 ft of a turn or decision sign)  
Should be placed soon after turns, to confirm destination. ( Pavement markings can also act as confirmation signs)

**Decision Signs (2)**

These signs mark the junction of two or more bike routes. These signs inform bicyclists of a designated route as well as key destinations and distance.

**MUTCD PLACEMENT**

Near-side intersections where bike routes merge with another route or along the route to indicate a nearby destination.

**Turn Signs(3)**

These signs are used to indicate where a bikeway turns from one street onto another street. They include destinations, approximate distance and arrows.

**MUTCD PLACEMENT**

Near-side intersections where bike routes turn. Modified pavement markings on page 47 can also indicate the need to turn to the bicyclist.



1



2



3

# SIGNALS & SIGNS: VERTICAL

## ACTIVE WARNING BEACON FOR BIKE ROUTE AT UNSIGNALIZED INTERSECTION:

An Active warning beacon is a user-actuated sign with amber flashing lights that enhance the effectiveness of warning signs at unsignalized intersections or mid-block crosswalks.

Beacons can be activated with a push-button system or passively through detection.

Rectangular Rapid Flash Beacons (RRFBs), a type of active warning beacon, use an irregular flashing pattern that resembles emergency flashers on police vehicles. They can be installed on two-lane or multi-lane roadways.

Active warning beacons are used to alert drivers of the presence of bicycle and/or pedestrian crossings, the flashing lights enhance the awareness of all users and prompts vehicles to yield to pedestrians and bikes from a considerably longer sight distance improving safety.

## TYPICAL APPLICATIONS

- Where vehicle yield to bicycles and pedestrians compliance is low.
- At high-volume pedestrian/ bicycle crossings.
- To reinforce bicycle/pedestrian crossing priority at a particular zone or crossing.
- At mid block crossings where signal heads are not feasible or desired.

- 1 Solar-Powered RRFB can be a low-cost addition to an existing crossing
- 2 If a center island or median exist, installing RRFB here, helps improve driver yielding behavior.
- 3 "Shark Teeth" markings also aid to improve driver yielding behavior.

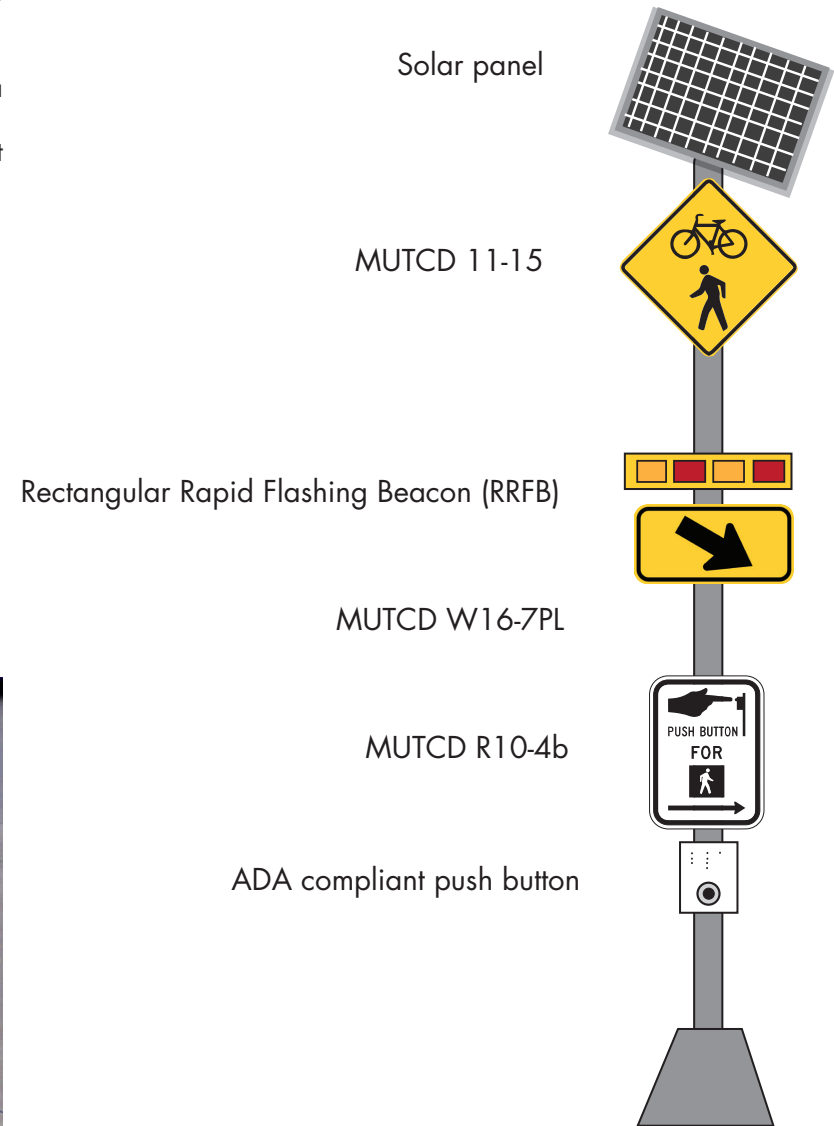
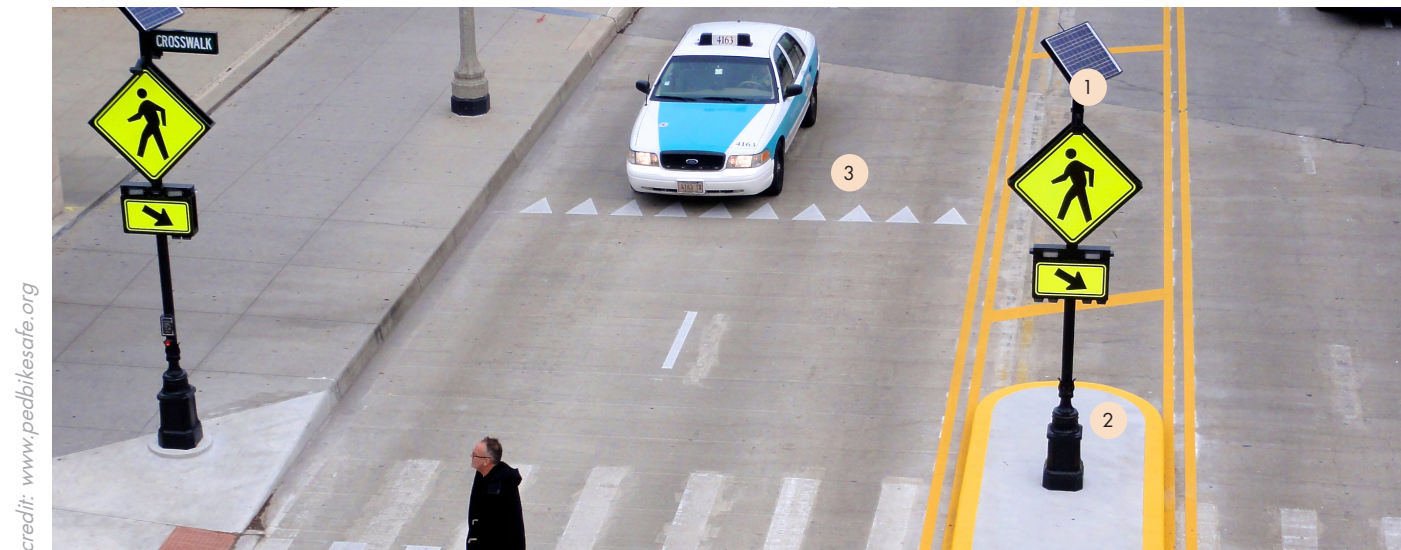

Fig 3.27 RRFB detail.



credit: www.pedbikesafe.org

Inductive loop vehicle detection is usually calibrated to the size or metallic mass of a car. In order for bicycles to be detected, loops must be calibrated for bicycles. Otherwise, undetected bicyclists must wait for a car to arrive at the intersection, or dismount their bikes to press the user activated crossing signal if available, or cross illegally.

**IN- PAVEMENT LOOP**

An induction loop embedded in the pavement that is calibrated to the size and metallic mass of bicycles in order to be detected.



- 1 If detection is not provided within the dedicated facility or shoulder, detection shall be visible to bicyclists through signs and/ or stencils that delineate detection zone so that bicyclists position the bicycles appropriately to active signal.
- 2 Bicycle detection should be provided in the bike lane and where bicyclists are intended to wait.

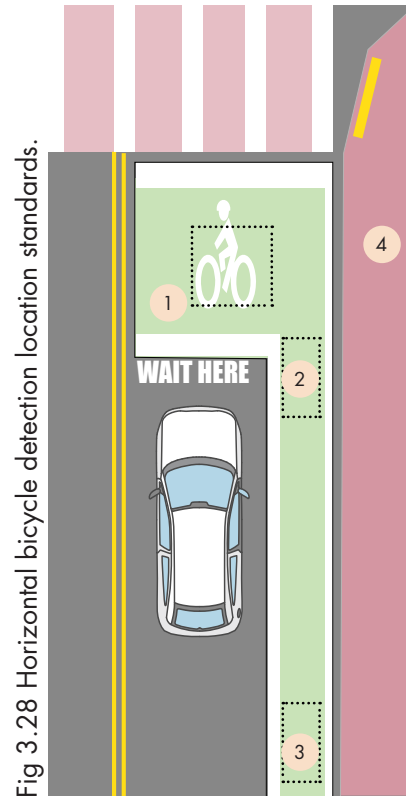

Fig 3.28 Horizontal bicycle detection location standards.

- 3 Streets with bike lanes or bikeable shoulders shall have bicycle detectors in the bike lane or shoulder. Detection shall be located where bicyclists are intended to travel and/or wait. If a leading signal detector is provided, it shall be located along the bike lane or in the outside travel lane. Detection at intersections shall be provided in the middle of the bike box or immediately behind the stop bar in the bike lane. Intersections without painted infrastructure shall provide detection in the center of the outside lane.

- 4 If provided, push-button activation shall be located so bicyclists can activate the signal without having to dismount their bikes. If used, push-buttons should have additional signage facing the bicyclists approach to increase visibility.

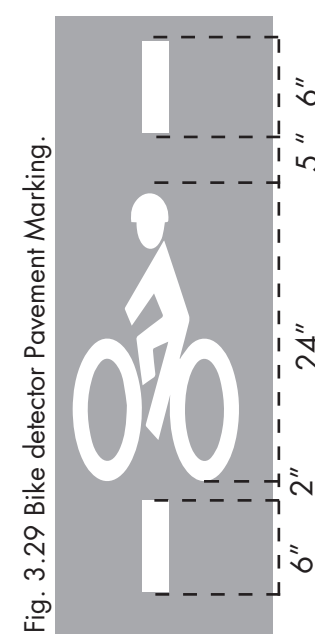

Fig. 3.29 Bike detector Pavement Marking.

**BENEFITS**

- Improves travel efficiency and reduces delay.
- Discourages bicyclist from running red lights without causing significant delays to automobile travel.
- Can be used to extend the green light phase in order to provide enough time for bicyclists to clear the intersection.

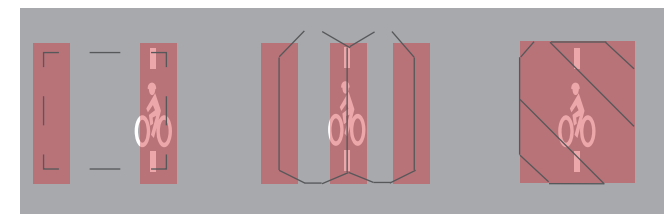

Fig 3.30 Signal detection areas by Loop Detector Type.



## SIGNALS & SIGNS: COORDINATED SIGNAL TIMING

Timing signals in a way that coordinates among all modes of travel helps to manage the progression speed of specific modes where uninterrupted flow is desired. Traditionally, timing and coordination of signals has been geared towards increasing vehicular traffic flow and reduce peak hour delay. The same tool can be used in order to optimize slower speeds, thus creating an uninterrupted flow for people traveling by bicycle or to achieve low vehicle progressions speeds for pedestrian-friendly corridors.

Signals may also be timed to coordinate transit along routes where transit has low variability.

### CONSIDERATIONS

- Coordinating traffic signals may reduce the number of stops along a corridor and provide a continuous traffic flow at the target speed.
- Progression speed should be set below the target speed instead of the existing 85th percentile speeds.
- Off-peak signal timing should be developed to reflect the lower traffic conditions.
- Weekend signal timing and coordination has the opportunity to incentivize alternative modes of travel.
- 

### SIGNAL TIMING FOR BICYCLISTS

Bicyclists traveling at a speeds between 13-15 mph are able to travel with minimum interruptions at intersections along a corridor, this results in a platoon of bicyclists along a corridor.

### SIGNAL TIMING IN DOWNTOWN AREAS

Coordinated signal timing is particularly useful in downtown areas where there is a consistent pedestrian flow and bicycle travel. Timing signals to reward slower motor vehicle speeds of 15- 20 mph gives priority to pedestrians and bicyclists.

### SIGNAL COORDINATION WITH TRANSIT

Shorter signal cycle lengths may improve transit times along transit routes. Coordination helps increase reliable turn-over and reduce side street delay.

### SIGNAL CYCLES AND LENGTHS

Traffic signal lengths have a very significant impact on the quality of the urban environment. Long signals compounded over multiple intersections turn streets into barriers and discourage pedestrian and bicyclist activity.

When signal cycles are timed for corridor priority, major streets become barriers that separate neighborhoods rather than join them.

The graphic above shows how major streets get almost 4 times more green signal than the side streets. This scheme unfortunately incentivizes people traveling by car to avoid minor streets and increase congestion on the main routes. At the same time, Longer green periods hinder pedestrian crossing times, resulting in pedestrians crossing the major streets without a proper cross-signal. This often translates into pedestrian/driver collision

Shorter cycles along both major and minor streets help the city function as a complete network. The recalibration of signal timing into shorter intervals of a 3:2 ratio allows pedestrians and bicyclists to cross streets more often while also relieving major streets from unnecessary congestion.

Cycle lengths shorter than 60 seconds are only recommended where a city uses "feathering" (intervals that decrease as they approach a pinch point) to relieve an upstream bottleneck. In such cases, adequate crossing time for pedestrians should be taken into account based on a crossing speed between 2.5–3.5 feet per second.

High-Visibility crosswalks have very few benefits for pedestrians if the average pedestrian is not given sufficient time to cross the street. Consider elderly people, parents with strollers and/or small children and people with mobility and visual impairments.

**SHORT CYCLE LENGTHS OF 60-90 SECONDS ARE IDEAL FOR URBAN AREAS.**

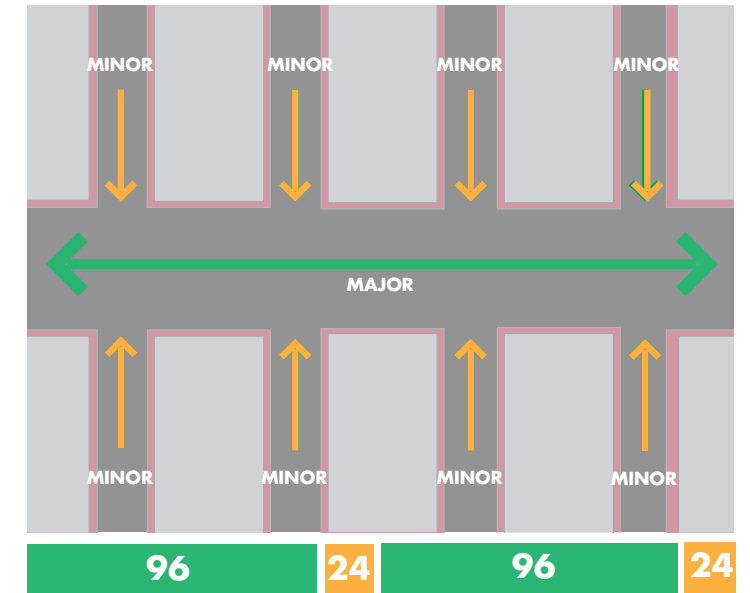

Fig 3.31 Signal timing as a barrier to multi-modal network connectivity.

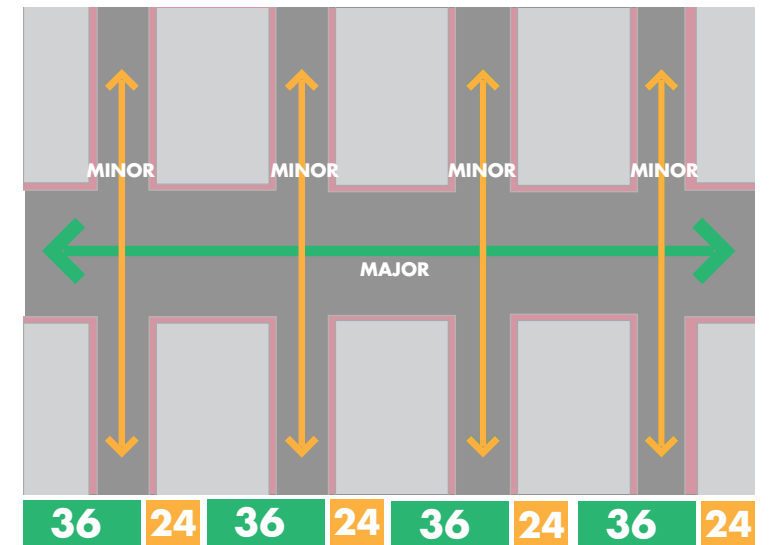

Fig 3.32 Signal timing in function of multi-modal network connectivity.



Signage provides users with meaningful information about navigating the built environment. Wayfinding, also known as environmental graphic design, incorporates the city's brand and identity.

Large scale wayfinding can help to brand neighborhoods within the city and provide opportunities for individuality while adhering to an overall design scheme.

### WAYFINDING PRINCIPLES

The following principles help make information spaces more navigable:

- Create an identity at each location.
- Use landmarks to provide orientation cues and memorable locations.
- Create regions with unique visual character.
- Limit choices to avoid confusion.
- Use maps or diagrams for overall orientation.
- Use sight lines to show what's ahead.

Effective wayfinding and signage that is rooted in the culture of the city and its design adds aesthetic value to the streetscape.

Signs should always aim to include graphics over words, universal signage minimizes the possibility of confusion. Wayfinding for users with mobility, hearing and visual impairments should be seamlessly integrated into the wayfinding system.

Creative wayfinding might also help develop neighborhood identities in terms of districts, which positively affects the ability of the user to navigate space as well as economic activity.

#### CREATE AN IDENTITY AT EACH LOCATION

Give every location a unique perceptual identity so that the user can orient himself in the larger context. Establish a unified visual language.

#### USE LANDMARKS TO PROVIDE CUES

A landmark is usually highly visible object that can be seen from specific directions at a distance. There are local landmarks, which are closer in proximity and global landmarks which tend to be larger and can be seen from various angles. Landmarks are commonly placed at decision points, where the user must choose a specific direction to follow.

#### CREATE WELL STRUCTURED PATHS

Space navigation paths should be well - defined from beginning to end. The user should be able to see the end of the path. If the path does not have a contiguous visual structure due to distance or directionality, additional signs must be placed to orient the user.

#### CREATE REGIONS WITH UNIQUE VISUAL CHARACTER

Subdivide larger regions into subregions that fit into the larger context. IE: using a flamingo as the over all Miami Beach Signage while each neighborhood might a specific color.

#### LIMIT CHOICES TO AVOID CONFUSION

Spaces should be designed coherently so that each path is clearly defined

#### USE MAPS OR DIAGRAMS

Wayfinding should incorporate various methods of communication and cater to different styles of learning. Diagrammatic wayfinding is a successful and easy way to convey information about a space if landmarks are well placed.

Detailed maps are useful in conveying the size of the space.

#### USE SIGHT LINES TO SHOW WHAT'S AVAILABLE

Give users a clear path of navigation in a particular direction

The Flamingo sculptures currently placed around the city, serve as small memorable landmarks, and are a good example of aesthetically pleasing wayfinding.

Other neighborhoods in the county like Little Havana, have also adopted picturesque sculptures as a way of branding and wayfinding with much success.







## COMMUNITY ENGAGEMENT

When stakeholders are involved, plans can be more inclusive and develop specific solutions for issues that otherwise might not be addressed.

Community engagement is a feedback loop where stakeholders and Miami Beach City officials inform the process of design.

Community engagement is the basis for a democratic process in street design. Understanding the needs of a particular community from the beginning has many advantages when it comes to planning and decision making. Successful community engagement has the following characteristics:

- It involves all sectors of the population.
- It's adapted to reach all audiences (Translation, hearing/ visual aids)
- Tailored to fit stakeholders schedules for maximum participation.
- Meetings are held more than once if possible
- Recorded information and meeting materials are made available on-line after meetings.
- Informal meetings can be held at libraries, outdoors or in partnership with local businesses
- that cater to the specific subject being discussed.
- Meetings are well advertised on official websites, blogs, newspapers, social media and around town in highly visible areas.

### EMERGING PRACTICES IN COMMUNITY ENGAGEMENT

Local governments are mandated to publish a notice for public meetings, information sessions and a variety of other meetings on the classified section of the news paper as well as their official website.

This type publication is merely informative and must transition from a formality to be seen as an opportunity for advertisement and participation in order to foster real community engagement.

#### ONLINE

Social media, blogs, forums and web based applications for reporting information enable citizen engagement and direct communication with City officials.

Web-based reporting applications allow the public to track concerns and incidents which may result in faster resolutions on the City's behalf. Concerns for specific areas may be cataloged by a specific address and compared to accidents reported on site in real time.

Small reports regarding citizen concerns and accidents may be presented graphically on a map every 90 days on [BIKEMIAMI BEACH.ORG](http://BIKEMIAMI BEACH.ORG). This tool informs The City on possible changes to an existing facility, the need for a dedicated signal, periodic observation, which then results in a efficient and safe environment for all users.

#### ON LAND

Traditional community engagement doesn't currently reach a diverse enough audience that is representative of the population the agencies try to serve. The following recommendations may help increase participation:

- The City may partner with local interest groups and foster the formation of such, in order to establish and maintain a partnership between the City and the public regarding bicycle and pedestrian interests.
- Public meetings should be held at a time when the most people can attend, and have translators available. Written material should be printed/translated in various languages including but not limited to: English, Spanish, Portuguese and Haitian Creole.
- The Miami Beach Art Deco Welcome Center, libraries, post office locations, and other government buildings, should have a designated display box that is easily recognizable. The display should have maps, safety information and any other information regarding the Miami Beach bicycle network and how it connects with adjacent municipalities.



Fig 4.1 Proposed Miami Beach bicycle information racks.

Cities often face challenges when it comes to project implementation. Approval processes, departmental coordination, budgeting processes and construction times, often result in delayed delivery of public projects according to the community's expectations.

Tactical Urbanism also known as Transitional tactics is a design/build process that in many cases shortcuts the rigid bureaucracy that often characterizes government processes.

The premise of Tactical Urbanism is "short-term action, long term change". Meaning that any design hypothesis can be tested out at a low-cost before investing heavily in a new idea.

Emerging practices in urban design around the world, might be appealing to Miami Beach residents and City Officials. However, cultural differences, climate, and overall understanding of necessary behavioral changes may prevent the City and its citizens from openly embracing change and new ideas.

Change in the built environment presents incredible opportunities and possible setbacks. The possibility of negatively affecting the integrity of the street network is an intricate concern for engineers, planners, designers, and emergency response forces as well as the general population.

Tactical urbanism enables :

- **SHORT TERM-ACTION:** The City and residents can work together to temporarily install possible solutions to problems like: lack of third-places, a new bicycle facility, bike parking, bicycle routes, traffic circles.
- **Low-cost investment:** Pilot projects require less investment (time and funds) since construction is not part of this phase.
- **TESTABLE SOLUTIONS:** In the case of a new protected bicycle lane, re striping the street or using temporary materials to divide the travel lane from the bicycle lane can be tested immediately by the public, while being actively monitored by City planners and engineers.
- **CITY-COMMUNITY PARTNERSHIP:** Tactical Urbanism can be carried out as a community event. This approach incentivizes citizens to take ownership of the positive changes happening in their built environment while being informed of the processes shaping the future of Miami Beach as a more inclusive, multi-modal and innovative City.
- **LONG-TERM CHANGE:** By instituting Tactical Urbanism as a necessary step in any new construction/change, cities can analyze in great detail the impacts of proposals before committing large amounts of time. In addition, actively informing residents and visitors of these projects from the beginning stages, gather necessary support that increases gradually before moving into the building phases.

"Tactical Urbanism functions as the Urban Design equivalent to the Hypothesis Testing/ Analysis steps of the Scientific Method. Thus, enabling the City to test out proposals in the built environment at a low-cost and actively gathering data from users in order to make informed decisions for consequent stages"

Tactical urbanism can be applied to projects of small, medium and large scale.

- It functions as the urban design equivalent of hypothesis-testing in the scientific method.
- Allows for fluidity, rather than rigid parameters.
- Calls for citizen participation from building + testing in order to gather real data that informs the consequent building/more permanent stages.
- Promotes high- levels of civic engagement.



Fig 4.2 The role of tactical urbanism.



## TACTICAL URBANISM

In recent years, Tactical Urbanism has proved to be an effective step in the design/build process. In addition, Tactical Urbanism projects have proved to be true catalyst in the implementation of innovative temporary ideas into government programs like the Pavement to Parks program in the City of San Francisco.

Tactical Urbanism projects range in scope, and serve different purposes from purely aesthetic to highly functional alternative uses in the public realm. The following examples have been widely successful in various cities around the country:

### **CURB**

The street curb has generally been confined to serve as the physical separation element between pedestrians and cars. Curbside configurations include street furniture and vegetation at times. However, curbside lanes are either on-street parking or travel lanes.

Envisioning the potential of existing curbside parking through tactical urbanism interventions has had a positive, measurable impact in the public realm.

Extending the curb can be done by reallocating on-street parking space onto the curb dimensions; sometimes this is coupled with re-striping street lanes and reducing travel lane widths as a traffic calming measure.

### **WIDENING THE SIDEWALK (1)**

As the Miami Beach Bicycle Master Plan is developed, Miami Beach neighborhoods will see an increase in multimodal transportation. Changes in transportation modes may allow certain neighborhoods to expand their sidewalks in order to accommodate more pedestrian activity a dedicated bus lane, or a sidewalk-level bicycle route.

Sidewalks can be temporarily expanded by using gravel, bollards, planters or bollards in order to delineate the new pedestrian space or bicycle facility.

### **ROAD DIET (2)**

The City may choose to install temporary chicanes in order to test traffic calming solutions or to enact an already approved traffic calming project before permanent construction takes place.

### **BICYCLE PARKING (3)**

Curbside parking spaces can also serve as bicycle parking.

A parallel parking space accommodates 1 car and has the potential to accommodate 10 bicycles side by side. More or less bicycles can be accommodated depending on the design.

### **DECO BIKE/ BIKE SHARING (4)**

Miami Beach has already experienced the success of bike sharing programs. Citi Bike/ Deco Bike has grown in popularity and support among residents and tourists. Bike sharing makes transportation more accessible while reducing traffic congestion. Removing a few parking spaces around The City to accommodate bike docking stations is a sensible trade off.

### **PARK(ing) Day! to PARKLETS (5)**

The concept of parklets sprouted from the PARK(ing) Day initiative. The premise of PARK(ing) Day is based on paying for a parking space for a set amount of hours and temporarily installing a creative alternative to typical use of the space. People have installed libraries, parks, yoga spaces, stages for various performances, mini-golf, etc.

The flexibility and inherent legality of occupying the space for an alternate use while paying the parking meter is a clever way to physically manifest creative ideas while engaging the community. Parklets function as the permanent manifestation of some of the parking day ideas.

Businesses and neighborhoods in general benefit from parklets in the many forms they manifest in. Whether as extra seating, a small garden, bicycle parking or a stage, parklets attract locals and visitors traveling by foot or bike, thus increasing street activity and potential sales. Generating positive street activity, as mentioned in this guide, is an effective way to keep the public realm active and safe.

In addition to the uses mentioned above, parklets function as a traffic calming measure when implemented on both sides of a corridor by creating the slalom effect.

### **STREET (6)**

Festivals, grower's markets, ciclovias and block parties take place on the public realm. Temporary street closures are an effective way to activate business districts, promote community interaction and participation, and incentivize non-motorized modes of transportation.

Street closures can be seasonal or year long on weekends or off-peak hours depending on the location and traffic volume. Restricting access on already low-traffic neighborhood streets allows children to play outside safely, interact with neighbors and increases the overall vibrancy of communities. Longer corridor closures can be coordinated with local businesses in order to boost sales periodically.

**INTERSECTIONS (7)**

Intersections are the convergence point for all users. Sometimes due to engineering standards or naturally occurring “awkward” geometry, the effectiveness of intersections is directly affected. The result is an over designed intersection that, although accommodates all users, could be redesigned to expand public space. Redesigning intersections in order to install public plazas or pocket parks may require the permanent closure of a block-length(s) of a street. Careful traffic analysis reviews and community engagement are crucial in order to gather information/support for intersection redesign into any type of public space.

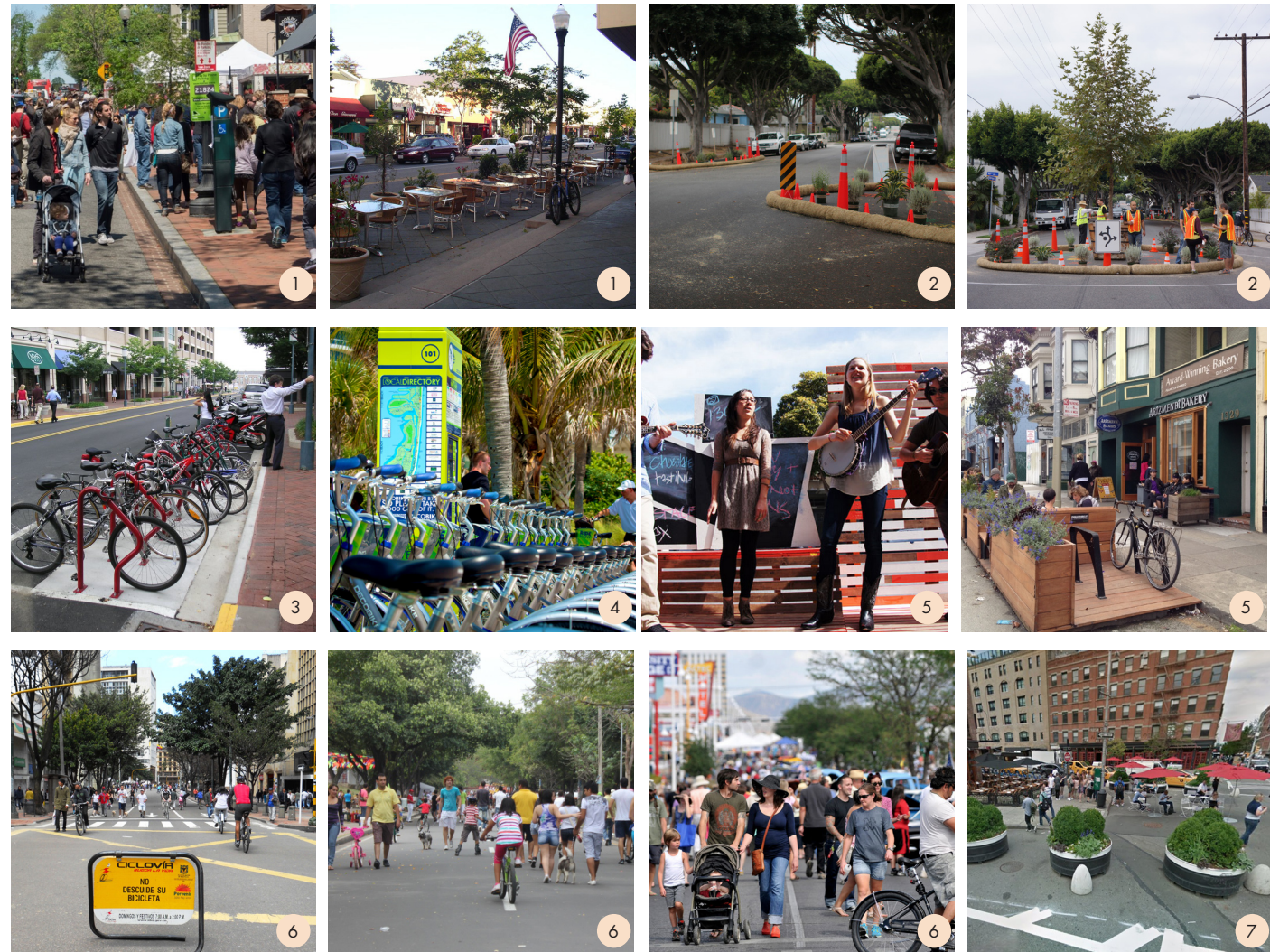



## LIST OF FIGURES

|   |    |
|---|----|
| Fig1.1 Vehicle-oriented street design segregates uses in communities. ....                                |    |
| Fig1.2 Multi-modal streetscape design allows for inclusion, efficiency and rich social interaction.....   |    |
| Fig1.3 Examples of “complete streets”elements.....  |    |
| Fig1.4 Pedestrian level of injury in relation to automobile travel speed. ....                            |    |
| Fig1.5 Example of elements present in a pedestrian priority zone. ....                                    |    |
| Fig 2.1 General multi-modal streetscape components. ....  |    |
| Fig 2.2 Street Type matrix.....   | 19 |
| Fig 2.3 Standard multi-modal boulevard streetscape assembly.....  | 20 |
| Fig 2.4 Typical multi-modal transit boulevard streetscape assembly at platform section.....               | 22 |
| Fig 2.5 Multi-modal commercial avenue assembly with protected bike facilities.....                        | 23 |
| Fig 2.6 Multi-modal residential avenue streetscape assembly with protected bike facilities.....           | 24 |
| Fig 2.7 Multi-modal urban neighborhood street streetscape assembly with conventional bike facilities..... | 25 |
| Fig 2.8 Typical neighborhood street streetscape assembly.....   | 26 |
| Fig 2.9 Multi-modal main street streetscape assembly with sidewalk-level protected bike facilities. ....  | 27 |
| Fig 2.10 Typical non-motorized street (multimodal optional).....  | 28 |
| Fig 2.11 Typical shared space.....  | 29 |
| Fig 2.12 Typical commercial alley (a).....  | 30 |
| Fig 2.13 Typical commercial alley (b) ....  | 31 |
| Fig 2.14 Pedestrian Priority Design Matrix.....   | 31 |
| Fig 2.15 Corner radii and pedestrian crossing safety. ....  | 34 |
| Fig 2.16 Pedestrian crossings should be highly visible. ....  | 35 |
| Fig 2.17 Poor visibility at crossing. ....  | 35 |
| Fig 2.18 Curb extension. ....   | 35 |
| Fig 2.19 Full curb extension with bioswale. ....  | 35 |
| Fig 2.20 Pedestrian Mid-block crossing. ....  | 35 |
| Fig 2.21 Z- offset pedestrian mid-block crossing. ....  | 36 |
| Fig 2.22 In pavement beacons ....   | 36 |
| Fig 2.23 MUTCD approved types of marked crosswalks ....   | 36 |
| Fig 2.24 Bicycle Priority Corridor design matrix. ....  | 36 |
| Fig 2.25 Typical “Heavy” Neighborhood greenway ....   | 44 |
| Fig 2.26 Typical “light” Neighborhood greenway. ....  | 45 |
| Fig 2.27 Neighborhood Greenway Heavy to Light continuum. ....   | 45 |
| Fig 2.28 Neighborhood Greenway,sharrows pavement markings. ....   | 46 |
| Fig 2.29 Pavement marking placement with parallel parking. ....   | 48 |
| Fig 2.30 Pavement marking placement on travel lane. ....  | 49 |
| Fig 2.31 Pavement marking dimensions. ....  | 49 |
| Fig 2.32 modified shared lane markings for route designation and directionality. ....                     | 49 |
| Fig 2.33 Advisory bike lane with shared lane markings. ....   | 50 |
| Fig 2.34 Buffered bicycle lane. ....  | 52 |
| Fig 2.35 Contraflow bicycle lane ....   | 53 |
| Fig 2.36 Combined turn lane at intersection approach. ....  | 54 |
| Fig 2.37 Through bicycle lane intersection approach.....  | 55 |
| Fig 2.38 Through bicycle lane with sharrows at intersection approach. ....                                | 56 |
| Fig 2.40 Conventional bicycle lane. ....  | 57 |
| Fig 2.41 Protected bicycle lane with bollards. ....   | 60 |
| Fig 2.42 Protected bicycle lane with planters. ....   | 60 |
| Fig 2.43 Protected bicycle lane with parked vehicles and buffer. ....                                     | 60 |
| Fig 2.44 Protected bicycle lane with mountable curb. ....   | 61 |
| Fig 2.45 Protected bicycle lane with modular curb . ....  | 61 |
| Fig 2.46 Protected bicycle lane with buffer and bicycle parking ....                                      | 61 |
| Fig 2.47 Sidewalk-level Protected bicycle lane with landscape buffer. ....                                | 62 |
| Fig 2.48 Sidewalk-level Protected bicycle lane with mountable curb (no parallel parking). ....            | 62 |
| Fig 2.49 Sidewalk-level Protected bicycle lane with parked vehicles, mountable curb & buffer... ..        | 62 |
| Fig 2.50 Sidewalk-level Protected bicycle lane with mountable curb and parallel parking. ....             | 63 |
| Fig 2.51 Sidewalk-level Shared use path. ....   | 63 |
| Fig 2.52 Sidewalk-level Protected bicycle lane driveway condition. ....                                   | 63 |
| Fig 2.53 Typical dimension of buffer stripes. ....  | 64 |
| Fig 2.54 Mountable curb detail. ....  | 64 |
| Fig 2.55 Planter detail ....  | 64 |
| Fig 2.56 Bollard detail. ....   | 64 |
| Fig 2.57 Modular curb detail. ....  | 64 |
| Fig 2.58 Protected bike lane intersection approach. ....  | 65 |
| Fig 2.59 ADA Accessible protected bike lane intersection approach. ....                                   | 66 |
| Fig 2.60 Bike Corral protected bike lane intersection approach. ....                                      | 67 |
| Fig 2.61 Protected bike lane configurations matrix. ....  | 68 |
| Fig 2.62 Bicycle box at intersection. ....  | 70 |
| Fig 2.63 Pavement markings variations at intersection (a) ....  | 71 |
| Fig 2.64 Pavement markings variations at intersection (b). ....   | 71 |
| Fig 2.65 Two- stage left turn bike box at median. ....  | 72 |
| Fig 2.66 Two - stage left turn bike box at parallel parking configuration. ....                           | 72 |
| Fig 2.67 Two- stage left turn bike box and through bike lane configuration. ....                          | 73 |
| Fig 2.68 Two- stage left turn at mid-block. ....  | 73 |
| Fig 2.69 Two- stage left turn at bike box. ....   | 73 |
| Fig 2.70 Right turn-only movement with traffic diverter. ....   | 74 |
| Fig 2.71 Bike box with partial closure configuration. ....  | 75 |
| Fig 2.72 Bicycle facilities transition (a) ....   | 76 |
| Fig 2.73 Bicycle facilities transition (b) ....   | 76 |
| Fig 2.74 Protected bike lane bend-out condition. ....   | 77 |
| Fig 2.75 Protected bike lane bend-in condition ....   | 77 |
| Fig 2.76 Protected intersection. ....   | 77 |
| Fig 2.77 Set back crossing. ....  | 78 |

|   |     |
|---|-----|
| Fig 2.78 Mountable truck apron. ....  | 78  |
| Fig 2.79 Vehicle visibility of bicyclist intersection approach. ....                                      | 79  |
| Fig 2.80 Bicyclist visibility of motor vehicle at intersection approach. ....                             | 79  |
| Fig 2.81 Pedestrian and Bicyclist median refuge island. ....  | 80  |
| Fig 2.82 Pedestrian and Bicyclist median refuge island with full closure. ....                            | 81  |
| Fig 2.83 Typical roundabout with pedestrian crossings and separated bike facilities. ....                 | 82  |
| Fig 2.84 From sprawl to complete intersections matrix. ....   | 83  |
| Fig 2.85 Traffic calming countermeasures at neighborhood scale. ....                                      | 84  |
| Fig 2.86 Reverse angle parking. Proposed condition for 51st street @ Cherokee Avenue in Miami Beach. .... | 85  |
| Fig 2.87 Street types and countermeasures matrix. ....  | 86  |
| Fig 2.89 Undesirable driveway condition. ....   | 88  |
| Fig 2.90 Consolidated (desirable) driveway condition. ....  | 88  |
| Fig 2.91 LRT/ BRT transit center platform condition. ....   | 89  |
| Fig 2.92 Transit stop standards, plan view. ....  | 90  |
| Fig 2.93 Shelter bicycle parking example. ....  | 90  |
| Fig 2.94 Sidewalk- level protected bicycle lane at transit stop (a). ....                                 | 91  |
| Fig 2.95 Sidewalk- level protected bicycle lane at transit stop (b). ....                                 | 92  |
| Fig 2.96 Sidewalk- level protected bicycle lane at transit stop (c). ....                                 | 93  |
| Fig 2.97 Sidewalk- level protected bicycle lane at transit stop (d). ....                                 | 94  |
| Fig 2.98 Sidewalk- level protected bicycle lane at transit stop (e). ....                                 | 95  |
|   |     |
| Fig 3.1 Bioswale cross section. ....  | 101 |
| Fig 3.2 Public Frontage Assembly Matrix. ....   | 104 |
| Fig 3.3 Private Frontage Assembly types. ....   | 105 |
| Fig 3.4 Pedestrian realm. ....  | 106 |
| Fig 3.5 Parklet standards (a). ....   | 108 |
| Fig 3.6 Parklet standards (b). ....   | 109 |
| Fig 3.7 City-wide existing bicycle parking locations. ....  | 117 |
| Fig 3.8 City-wide existing + Proposed bicycle parking locations ....                                      | 118 |
| Fig 3.9 City-wide existing bicycle parking intensity. ....  | 118 |
| Fig 3.10 Bicycle parking types matrix. ....   | 121 |
| Fig 3.11 Bike parking on sidewalk.(a).....  | 124 |
| Fig 3.12 Bike parking on sidewalk.(b) ....  | 124 |
| Fig 3.13 Underutilized curb space at corner.....  | 125 |
| Fig 3.14 Bicycle parking/ corral at corner. ....  | 125 |
| Fig 3.15 Inverted U bicycle parking installation standards.....   | 128 |
| Fig 3.16 Bike stall installation standards.....   | 128 |
| Fig 3.17 MUTCD - R10 3e. ....   | 130 |
| Fig 3.18 MUTCD sequence for Pedestrian Hybrid Beacon (Interim approval July 2008). ....                   | 132 |
| Fig 3.19 MUTCD R-10-15 alt. ....  | 132 |
| Fig 3.20 R-10-15 alt. A. ....   | 133 |
| Fig 3.21 R-10-15 alt. B. ....   | 133 |
| Fig 3.22 MUTCD R4-4. ....   | 133 |

|  |     |
|--|-----|
| Fig 3.23 MUTCD R1-2.....   | 133 |
| Fig 3.24 MUTCD W1 1-1.....   | 133 |
| Fig 3.25 MUTCD W1-7 alt.....   | 133 |
| Fig 3.26 MUTCD W1 1-15.....  | 133 |
| Fig 3.27 RRFB detail.....  | 134 |
| Fig 3.28 Horizontal bicycle detection location standards.....                | 135 |
| Fig. 3.29 Bike detector Pavement Marking.....                                | 135 |
| Fig 3.30 Signal detection areas by Loop Detector Type.....                   | 135 |
| Fig 3.31 Signal timing as a barrier to multi-modal network connectivity..... | 136 |
| Fig 3.32 Signal timing in function of multi-modal network connectivity.....  | 137 |
| Fig 3.33 City of Miami Beach neighborhood map.....                           | 139 |
|  |     |
| Fig 4.1 Proposed Miami Beach bicycle information racks.....                  | 142 |
| Fig 4.2 The role of tactical urbanism.....                                   | 143 |